

### 3/2 Introduction

#### 3/5 HMI Software in the TIA Portal

3/5	Visualization
3/6	SIMATIC WinCC (TIA Portal) Engineering
3/10	<u>SIMATIC WinCC (TIA Portal) Runtime</u>
3/11	WinCC Runtime Advanced
3/15	WinCC Runtime Professional
3/21	WinCC Runtime communication
3/27	<u>SIMATIC WinCC (TIA Portal) options</u>
3/29	WinCC Recipes
3/31	WinCC Logging
3/33	WinCC Audit
3/34	SIMATIC Logon
3/35	WinCC Sm@rtServer
3/39	WinCC Server / WinCC Client
3/41	WinCC Redundancy

#### 3/42 TIA Portal options

3/42	SIMATIC Visualization Architect
3/43	SIMATIC ProDiag

#### 3/44 Software for energy management

3/45	SIMATIC Energy Suite
3/49	SIMATIC Energy Manager
3/55	SIMATIC powerrate

#### 3/58 SIMATIC WinCC flexible HMI system

3/58	Introduction
3/59	SIMATIC WinCC flexible ES
3/61	SIMATIC WinCC flexible RT
3/66	<u>SIMATIC WinCC flexible options</u>
3/67	WinCC flexible /ChangeControl
3/68	WinCC flexible /Archives
3/69	WinCC flexible /Recipes
3/70	WinCC flexible /Audit
3/71	SIMATIC Logon for WinCC flexible
3/72	WinCC flexible /Sm@rtAccess
3/73	WinCC flexible /Sm@rtService
3/74	WinCC flexible /OPC-Server
3/75	WinCC flexible /ProAgent

### 3/76

3/76	<b>SCADA system SIMATIC WinCC V7</b>
3/76	Introduction
3/77	SIMATIC WinCC V7
3/95	<u>SIMATIC WinCC options</u>
3/96	WinCC/Server
3/98	WinCC/Redundancy
3/99	WinCC WebNavigator
3/103	WinCC WebUX
3/105	WinCC/User Archives
3/106	WinCC DataMonitor
3/108	WinCC/PerformanceMonitor
3/111	WinCC/SES (Sequence Execution System)
3/113	WinCC/Audit & WinCC/ChangeControl
3/115	WinCC/Calendar Scheduler
3/116	WinCC/Event Notifier
3/117	WinCC/Open Development Kit (ODK)
3/118	WinCC/Connectivity Pack & WinCC Connectivity Station
3/120	SIMATIC TeleControl
3/125	<u>SCADA options</u>
3/126	WinCC IndustrialDataBridge
3/129	SIMATIC Process Historian
3/131	SIMATIC Information Server

#### 3/133 WinCC add-ons and partner management

3/133	Introduction
-------	--------------

#### 3/135 SCADA System SIMATIC WinCC Open Architecture

3/135	SIMATIC WinCC Open Architecture
3/145	SIMATIC WinCC Open Architecture add-ons

#### 3/151 Notification software for mobile devices

3/151	SIMATIC Notifier <b>NEW</b>
-------	-----------------------------

#### 3/153 SIMATIC ProAgent process diagnostics software

3/153	SIMATIC ProAgent
-------	------------------

# HMI Software

## Introduction

### Overview

#### **SIMATIC HMI – Efficient to a new level**

Innovative, efficient, scalable and open software for the machine-level area and for SCADA solutions.

With the SIMATIC WinCC (TIA Portal), SIMATIC WinCC and SIMATIC WinCC Open Architecture product families, SIMATIC HMI offers visualization and configuration software for the entire HMI spectrum, from the machine-level area right up to SCADA systems.

- SIMATIC WinCC (TIA Portal)  
Creation of applications in the machine-level area and of process visualization or SCADA systems
- SIMATIC WinCC flexible  
Maintenance of visualization solutions in the machine-level area
- SIMATIC WinCC V7 SCADA system  
Creation of process visualization or SCADA systems
- SIMATIC WinCC Open Architecture SCADA system  
Creation of applications with a high demand for customer-specific adaptations, large and/or complex applications, as well as projects that demand special system requirements and functions

<http://www.siemens.com/hmi-software>

#### **SIMATIC WinCC (TIA Portal)**

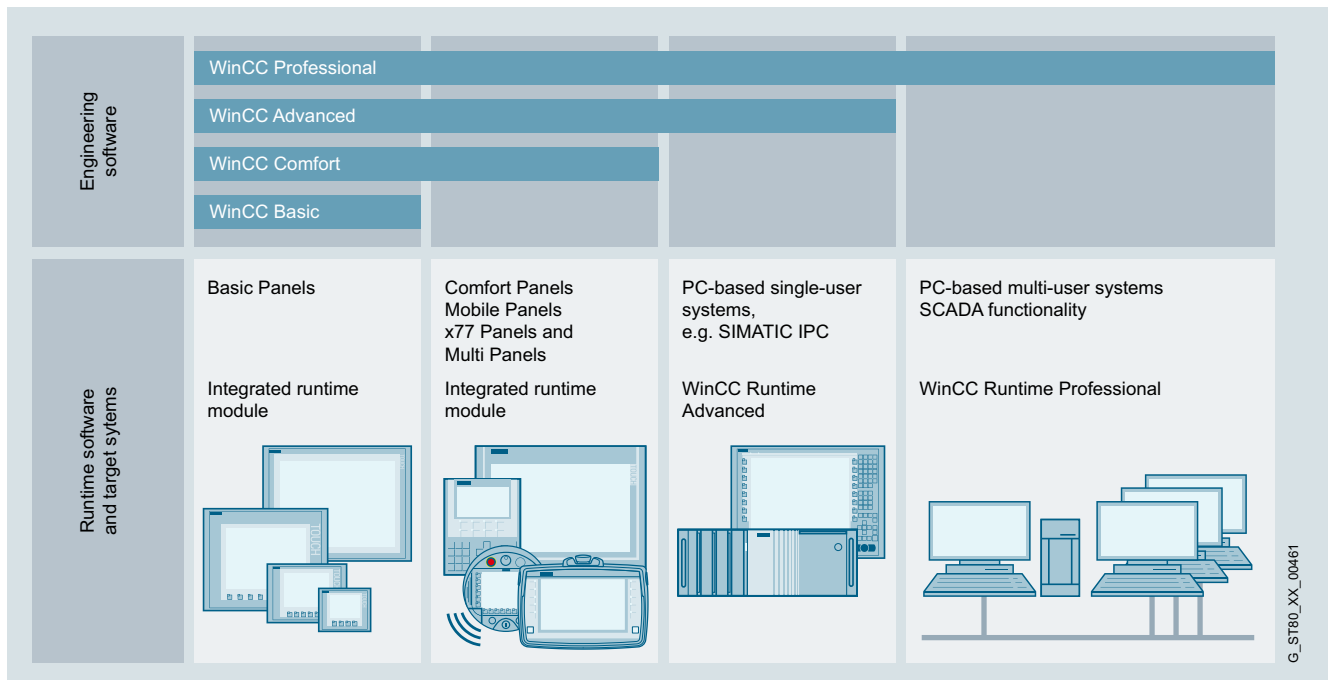

WinCC (TIA Portal) is based on the central engineering framework Totally Integrated Automation Portal (TIA Portal) which offers users a uniform, efficient and intuitive solution to all their automation tasks. SIMATIC WinCC (TIA Portal) covers applications in the machine-level area and applications in the process visualization or SCADA environment. WinCC (TIA Portal) offers the uniform and scalable configuration tools WinCC Basic, Comfort, Advanced and Professional for configuring the current SIMATIC HMI operator panels:

- SIMATIC Basic Panels (without Key Panel)
- SIMATIC Comfort Panels
- SIMATIC Mobile Panels
- PC-based systems for the machine-level area
  - SIMATIC WinCC Runtime Advanced
  - SIMATIC WinCC Runtime Professional

In addition, WinCC (TIA Portal) offers:

- Intuitive user interface with maximum degree of operator friendliness
- Clear configuration of devices and network topologies
- Shared data management and uniform symbols via controller and HMI
- Optimum interaction with the controller and HMI in a working environment
- Powerful editors for efficient engineering
- Integrated mass data operations for efficient configuration
- System diagnostics as an integral component
- Comprehensive library concept

<http://www.siemens.com/wincc-tia-portal>

**Overview** (continued)**SIMATIC SCADA Systems**

The data volume in modern industrial plants is growing continuously – and along with it the challenges faced by the SCADA solutions used: Enormous data volumes must be administered and archived for the long term.

This is accompanied by increasing demands on performance. Technologies, including some from the consumer environment, are finding their way into industry. Globalization calls for higher-level SCADA systems that can be used worldwide – and the need for mobile access to plant information is also growing. On top of all these requirements – in these times of ever increasing (energy) costs – is the need to improve energy efficiency and productivity.

**With SIMATIC SCADA systems, you are fit for the future**Efficiency

Efficiency: As a key to greater productivity, SIMATIC SCADA systems combine efficient engineering with high-performance archiving and maximum data security. These features provide the basis for efficient operations management and intelligent production analyses.

Scalability

We offer stationary and mobile solutions to cover increasing demands – security guaranteed. In this area, we apply more than 15 years of SCADA know-how from all industry sectors. No matter how large or small your request is – we have the right answer.

Innovation

Stay informed with mobile SCADA solutions anywhere and at any time – including with existing tablet and smartphone hardware. The use of multi-touch gestures in the industrial environment opens the door for modern operating concepts.

Openness

Since international standards and system-internal script and programming interfaces are supported, it is easy to implement special requests.

<http://www.siemens.com/scada>

**SIMATIC WinCC V7 SCADA system**

The process visualization or SCADA system for visualizing and operating processes, production flows, machines and plants in all sectors – from the simple single-user station through to distributed multi-user systems with redundant servers and cross-location solutions with web clients.

WinCC is the information hub for company-wide, vertical integration (process visualization and platform for IT & business integration).

- All HMI functions on-board with industry-standard functions for signaling and acknowledging events, archiving of messages and measured values, logging of all process and configuration data, user administration and visualization (WinCC basic software).
- Company-wide, flexible client/server structures with operator stations on the web, distributed servers and data integrity thanks to redundancy
- Easy to integrate over standard interfaces such as OPC (OLE for Process Control), WinCC OLE-DB, VBA (Visual Basic for Applications), VB script, C-API (ODK)
- Integration platform in the company thanks to the Historian functionality integrated into WinCC based on the Microsoft SQL Server, standard and programming interfaces and tools and clients for evaluation
- Modular expansion with options and add-ons as well as individual functional expansions with VB Script, Visual Basic for Applications, C-API (ODK) and integration of ActiveX elements.

<http://www.siemens.com/wincc-v7>

**Overview** (continued)**SIMATIC WinCC Open Architecture SCADA system**

The SIMATIC WinCC Open Architecture (WinCC OA) SCADA system is designed for applications with high demand for customer-specific adaptations, large and/or complex applications, as well as projects that demand special system requirements and functions.

SIMATIC WinCC Open Architecture demonstrates its high performance in networked and redundant high-end control systems in particular. From the field level to the control station, from the machine to the company headquarters – integrated, high-performance communication is ensured. In every situation, a high level of availability, reliable information, fast interaction and user friendliness are guaranteed. Applications can also be changed without interrupting the process. Profitability, efficiency and safety are therefore always in equilibrium.

With its hot-standby redundancy and disaster recovery system, SIMATIC WinCC Open Architecture demonstrates its reliability in a wide range of business-critical applications. SIMATIC WinCC Open Architecture can be used on any platform and is available for Windows, Linux, iOS and Android.

SIMATIC WinCC Open Architecture is open for independent in-house developments, which means that ideas can be turned into new applications quickly and easily.

- Object-orientation supports efficient engineering and flexible plant expansion
- For large, distributed systems with up to 2 048 servers
- Scalable – from a small single-user system up to a networked, redundant high-end system
- WinCC OA can be used on any platform, and is available for Windows, Linux, iOS and Android
- Hot-standby redundancy and disaster recovery system assure maximum fail-safety and availability
- WinCC OA offers a platform for customer-specific solutions
- Extensive driver and interfacing options: S7, SINAUT, OPC, OPC UA, Modbus, IEC 60870-5-101/104, DNP3, BACnet, and more than 25 native drivers available
- Flexible logging of data either in file-based value archive or in a relational database (ORACLE)
- Create and reuse your own libraries – working with already existing object libraries and easy, individual modifications (customer design, specific changes)
- Modular expansion using options and add-ons as well as individual functional expansions by means of own script language CONTROL, API (C++) and integration of ActiveX elements
- Integration of TIA Projects using TIA Importer for S7-1200 and S7-1500

<http://www.siemens.com/wincc-open-architecture>

**PC-based HMI solutions (machine-level / SCADA) with SIMATIC industrial PCs**

Our reliable and innovative SIMATIC IPC industrial PCs are the optimal PC hardware platforms. SIMATIC industrial PCs are offered with low-cost software packages. For runtime versions with SIMATIC WinCC V7, WinCC Runtime Professional or WinCC Runtime Advanced visualization software products, as well as the SIMATIC WinAC RTX (F) software controller. The simultaneous purchase of industrial PC and software package results in a price advantage.

SIMATIC SCADA and SIMATIC IPCs

Perfect interaction for optimum productivity.

- Price advantage as "Package" comprising hardware and software
- System-tested solutions reduce testing overhead
- Simple ordering and synchronized logistics

Only if ordered together with the SIMATIC IPC.

<http://www.siemens.com/scada-ipc>

### Overview



#### **SIMATIC WinCC (TIA Portal) engineering software**

Family of configuration systems with WinCC Basic, Comfort, Advanced and Professional for SIMATIC operator panels, as well as for the WinCC Runtime Advanced and WinCC Runtime Professional PC-based visualization systems.

#### SIMATIC WinCC Runtime Advanced visualization software

- PC-based HMI solution for single-user systems directly at the machine
- Basic package for visualization, reporting and logging, user administration, can be expanded flexibly with VB scripts
- Basic package expandable by means of option packages
- Can be integrated into automation solutions based on TCP/IP networks
- Expanded service concepts with remote operation, diagnostics and administration over the intranet and Internet in combination with email communication

<http://www.siemens.com/wincc-advanced>

#### SIMATIC WinCC Runtime Professional visualization software

- PC-based operator control and monitoring system for visualization and operator control of processes, production flows, machines and plants in all sectors – from the simple single-user station through to distributed multi-user systems and cross-location solutions with web clients. WinCC Runtime Professional is the information hub for corporation-wide vertical integration.
- Industry-standard functions for signaling and acknowledging events, archiving of messages and measured values, logging of all process and configuration data, user administration, can be expanded flexibly with VB and C scripts
- Basic package expandable by means of option packages
- Also included are APIs for the Runtime to utilize the open programming interfaces

<http://www.siemens.com/wincc-professional>

## HMI Software

### HMI Software in the TIA Portal

#### SIMATIC WinCC (TIA Portal) Engineering

##### Overview

- Integrated family of engineering tools for configuring SIMATIC HMI operator panels, as well as for the PC-based visualization systems WinCC Runtime Advanced and WinCC Runtime Professional.
- WinCC (TIA Portal) is based on the new central engineering framework Totally Integrated Automation Portal (TIA Portal), which offers the user a uniform, efficient and intuitive solution to all automation tasks.
- WinCC (TIA Portal) also offers uniform engineering from the Basic Panel through to SCADA applications.
- Together with the STEP 7 (TIA Portal) products, WinCC (TIA Portal) forms the optimum solution for integrated, efficient engineering.

Current versions:

- SIMATIC WinCC Basic V15.1
- SIMATIC WinCC Comfort V15.1
- SIMATIC WinCC Advanced V15.1
- SIMATIC WinCC Professional V15.1

##### Benefits

- The integrated configuration software reduces training, maintenance and service overhead and protects the customer's investments.
- Minimized engineering overhead and reduction of lifecycle costs thanks to Totally Integrated Automation (TIA)
- Minimized configuration overhead due to reuse of scalable and dynamizable objects
- Intelligent tools for efficient and simple configuration:
  - Wizard for defining the basic structure of the HMI project
  - Table-based editors simplify the generation and processing of similar types of objects, e.g. for tags, texts, or alarms.
  - Complex configuration tasks such as the definition of paths of motion or the creation of the fundamental operator prompting are simplified by means of graphical configuration.
- Comprehensive support of multi-language configurations for worldwide use
  - Selectable views for entering configuration data in several languages
  - System and user-specific text lexicons
  - Export/import of language-dependent texts
- Security of investment due to
  - Import of the configuration from WinCC flexible 2008 SP2, 2008 SP3 and 2008 SP5
  - Transfer of the configuration from WinCC V7.0 SP3, V7.2, V7.3 and V7.4

##### Application

SIMATIC WinCC in the editions Basic, Comfort, Advanced and Professional are innovative engineering tools for configuring SIMATIC HMI operator panels, as well as for the PC-based visualization systems WinCC Runtime Advanced and WinCC Runtime Professional.

Depending on the selected product, various target systems can be configured:

###### WinCC Basic

- Basic Panels 1<sup>st</sup> Generation
- Basic Panels 2<sup>nd</sup> Generation

###### WinCC Comfort

As WinCC Basic, plus:

- Comfort Panels
- Mobile Panels 2<sup>nd</sup> Generation
- Mobile Panels x77 Series

###### WinCC Advanced

As WinCC Comfort, plus:

- SIMATIC PCs with WinCC Runtime Advanced:
  - SIMATIC Rack PCs
  - SIMATIC Box PCs
  - SIMATIC Panel PCs
  - SIMATIC S7 Open Controllers
- Standard PC with WinCC Runtime Advanced
- SINUMERIK PC: PCU 50.3, PCU 50.5

###### WinCC Professional

As WinCC Advanced, plus:

- SIMATIC PCs with WinCC Runtime Professional
  - SIMATIC Rack PCs
  - SIMATIC Box PCs
  - SIMATIC Panel PCs
- Standard PC with WinCC Runtime Professional

##### Design

The functionalities of the engineering tools of the SIMATIC WinCC family are based on each other.

The available editors are largely determined by the respective configurable target systems and their function. A more comprehensive engineering tool such as WinCC Advanced can always be used to configure lower-level target devices as well (e.g. Basic Panels).

A Powerpack can be used to upgrade from a smaller edition to a larger one. This does not apply to WinCC Basic.

The functionality of WinCC engineering tools already contains the configuration support of the available Runtime options for SIMATIC Panels, WinCC Runtime Advanced or WinCC Runtime Professional, irrespective of the purchased RT licenses. A separate license is required for the target system when using the configured Runtime options.

## Function

### **Integration into automation systems**

Integration into the SIMATIC Totally Integrated Automation Portal (TIA Portal)

- Shared data management and uniform symbols via the controller and HMI
- Optimum interaction between the controller and HMI in a working environment
- System diagnostics as an integral component
- Shared use of communication settings and process point definitions
- Simple dragging and dropping of tags from STEP 7 to an HMI device, e.g. onto a screen
- Excellent support for the new SIMATIC S7-1500 controllers
  - With symbolic addressing
  - Access to the new memory-optimized data blocks
  - New alarm and diagnostics concept

### **Configuration interface**

- Intuitive user interfaces with maximum degree of user friendliness
- Comprehensive and fast access to editors and project data
- Adaptive user interface of engineering tools depending on configured target system
- User-definable user interface settings, e.g. layout, tool bars
- Integrated mass data operations for efficient configuration

### **Project handling**

- Device-independent configuration data can be used on a variety of target systems without the need for conversion. The interface adapts itself to the functional possibilities of the target device.
- Cross-device utilization of common configuration data (e.g. message classes, text library) in multi-device projects
- Wizard-assisted definition of basic structure of HMI projects (e.g. display layout, operator prompting)

### **Screen editor with comprehensive options for efficient and fast screen configuration**

- Generation of interconnected screen objects via Drag&Drop, e.g. tags for the creation of input/output fields with process interfacing or buttons with screen selection function
- Definition of screen templates and functions (comparable with the Slide Master in MS PowerPoint)
- User-friendly editor for the creation of faceplates with defined external interface from screen objects
- Graphics-based configuration of motion paths
- Layer technology with up to 32 layers
- Tools for the Align, Rotate and Mirror functions

### **Import/export**

- of tags, links, text lists, and alarms

### **Tabular editors**

- Quick and easy generation and modification of configuration objects of the same type, e.g. tags, texts or messages, in tabular editors
- Intelligent default settings depending on previously configured data, e.g. automatic incrementing of addresses when generating consecutive tags
- Simple access to the properties of an object without superfluous user intervention
- Simultaneous modification of common object properties

### **Object-based data management with user-friendly search and edit options**

- Configuration of alarms and logs directly on the HMI tag, no switching between different editors
- Cross-reference list with direct access to all objects, e.g. for editing or selection
- Search for objects in entire project
- Text search and replace functions

### **Project documentation**

- Selective project documentation, the following contents can be printed:
  - An entire project
  - One or more project-associated devices
  - Contents of an editor
  - Libraries

### **Libraries for predefined/user-defined configuration objects**

- Storage of all configuration objects in the library, e.g. blocks and even entire screens or tags
- Faceplates can be constructed from simple screen objects on a customer-specific or project-specific basis. Changes to these faceplates can be made centrally (block definition).
- A large number of scalable and dynamizable screen objects is included in the scope of supply
- Size-scalable graphics for industrial applications are included in the scope of supply
- Preview function for library objects

### **Language support**

- Multilingual project creation (max. 32 languages) in editors thanks to selectable views
- Central management of language-specific texts and graphics in libraries
- Edit, export and import of texts for translation
- Language-specific graphics

### **Visual Basic and C-Script Support**

- IntelliSense function for fast programming of access to runtime objects
- Simple creation of control sequences in script code
- Visual Basic Script debugging in simulator and WinCC Runtime Advanced and WinCC Runtime Professional

### **Test and commissioning support**

- Simulation of HMI projects on engineering PC
- Marking of incomplete or incorrect configuration directly in the respective editor
- Jump to error cause based on alarm messages in the Compiler

## HMI Software

### HMI Software in the TIA Portal

#### SIMATIC WinCC (TIA Portal) Engineering

##### Function (continued)

##### Migration of existing HMI projects

- Data transfer in projects from WinCC flexible
- Data transfer in projects from WinCC

##### System prerequisites

WinCC engineering software	
<b>Processor type (recommended)</b>	Intel® Core™ i5-6440EQ (2.7 GHz)
<b>RAM (recommended)</b>	16 GB or more (32 GB for large projects)
<b>Hard disk</b>	SSD with at least 50 GB storage space available
<b>Operating systems</b>	64-bit operating systems <ul style="list-style-type: none"> <li>• Windows 7 Home Premium SP1 (WinCC Basic only)</li> <li>• Windows 7 Professional SP1</li> <li>• Windows 7 Enterprise SP1</li> <li>• Windows 7 Ultimate SP1</li> <li>• Windows 10 Home Version 1703 (WinCC Basic only)</li> <li>• Windows 10 Professional Version 1703</li> <li>• Windows 10 Enterprise Version 1703</li> <li>• Windows 10 Enterprise 2016 LTSC</li> <li>• Windows Server 2012 R2 StdE</li> <li>• Windows Server 2016 Standard</li> </ul>
<b>Screen resolution</b>	Recommended 1 920 x 1 080
<b>Optical drive</b>	DVD-ROM

##### Note:

Opening several instances of WinCC on your engineering PC at the same time may result in more demanding hardware requirements.

In addition to WinCC, Windows also requires space on the hard disk; e.g. free disk space should be available for the swap file. The following formula has proven itself in the past: Size of swap file = 3 x size of RAM. For further information, refer to your Windows documentation.

3

##### Ordering data

##### SIMATIC WinCC Basic software

##### SIMATIC WinCC Basic V15.1

- Data storage medium
- Download <sup>1)</sup>

6AV2100-0AA05-0AA5  
6AV2100-0AA05-0AH5

##### SIMATIC WinCC Comfort V15.1

- Data storage medium
- Download <sup>1)</sup>

6AV2101-0AA05-0AA5  
6AV2101-0AA05-0AH5

##### SIMATIC WinCC Advanced V15.1

Engineering software in the TIA Portal; for configuring SIMATIC Panels, WinCC Runtime Advanced; runs with Windows 7 (64-bit), Windows 10 (64-bit), WinSrv 2012 R2/2016 (64-bit), Class A; 6 languages: en, de, fr, es, it, zh

- Floating license; software and documentation on DVD; license key on USB flash drive
- Floating license; software, documentation and license key for downloading <sup>1)</sup>; Email address required for delivery

6AV2102-0AA05-0AA5

6AV2102-0AA05-0AH5

##### SIMATIC WinCC Professional V15.1

- Data storage medium
- 512 PowerTags
- 4 096 PowerTags
- Max. PowerTags

Download <sup>1)</sup>

- 512 PowerTags
- 4 096 PowerTags
- Max. PowerTags

6AV2103-0DA05-0AA5  
6AV2103-0HA05-0AA5  
6AV2103-0XA05-0AA5

6AV2103-0DA05-0AH5  
6AV2103-0HA05-0AH5  
6AV2103-0XA05-0AH5

##### Article No.

##### SIMATIC STEP 7 / SIMATIC WinCC Trial Licenses

On DVD, 21 day trial

##### SIMATIC STEP 7 Basic/Profess. SIMATIC WinCC Basic/Comfort/Advanced V15.1, trial license

6AV2102-0AA05-0AA7

##### SIMATIC STEP 7 Professional SIMATIC WinCC Professional V15.1, trial license

6AV2103-0AA05-0AA7

##### License: SIMATIC 50 h engineering with STEP 7 Professional Combo, WinCC Professional (incl. WinCC flexible 2008) and STEP 7 Safety Advanced (incl. Distributed Safety)

6ES7823-1GE05-0YA5

##### Powerpacks (without version change)

##### SIMATIC WinCC Basic to WinCC Comfort V15.1 <sup>2)</sup>

- Data storage medium
- Download <sup>1)</sup>

6AV2101-2AA05-0BD5  
6AV2101-2AA05-0BJ5

##### SIMATIC WinCC Comfort to WinCC Advanced V15.1

- Data storage medium
- Download <sup>1)</sup>

6AV2102-2AA05-0BD5  
6AV2102-2AA05-0BJ5

##### SIMATIC WinCC Advanced to WinCC Professional V15.1

- 512 PowerTags
- Download <sup>1)</sup>; 512 PowerTags

6AV2103-2AD05-0BD5  
6AV2103-2AD05-0BJ5

##### SIMATIC WinCC Professional V15.1

- 512 PT -> 4 096 PT
- 4 096 PT -> max. PT

6AV2103-2DH05-0BD5  
6AV2103-2HX05-0BD5

Download<sup>1)</sup>

- 512 PT -> 4 096 PT
- 4 096 PT -> max. PT

6AV2103-2DH05-0BJ5  
6AV2103-2HX05-0BJ5

<sup>1)</sup> Current information and availability regarding the new type of delivery can be found at: <http://www.siemens.com/tia-online-software-delivery>



Ordering data	Article No.	Article No.
<p><b>Software Update Service <sup>2)</sup></b></p> <p><b>Software Update Service (Standard Edition)</b></p> <p>The delivery is implemented according to the number of ordered SUS products (e.g. 10 upgrade packages with 10 DVDs, 10 USB flash drives, etc.)</p> <ul style="list-style-type: none"> <li>• SIMATIC WinCC Comfort</li> <li>• SIMATIC WinCC Advanced</li> <li>• SIMATIC WinCC Professional 512 PowerTags</li> <li>• SIMATIC WinCC Professional 4 096 PowerTags</li> <li>• SIMATIC WinCC Professional max. PowerTags</li> </ul>	<p><b>6AV6612-0AA00-0AL0</b></p> <p><b>6AV6613-0AA00-0AL0</b></p> <p><b>6AV2103-0DA00-0AL0</b></p> <p><b>6AV2103-0HA00-0AL0</b></p> <p><b>6AV2103-0XA00-0AL0</b></p>	<p><b>Upgrades</b></p> <p>Data storage medium</p> <p><b>WinCC V11..V14 -&gt; WinCC V15.1</b></p> <ul style="list-style-type: none"> <li>• SIMATIC WinCC Basic</li> <li>• SIMATIC WinCC Comfort</li> <li>• SIMATIC WinCC Advanced</li> <li>• SIMATIC WinCC Professional 512 PowerTags</li> <li>• SIMATIC WinCC Professional 4 096 PowerTags</li> <li>• SIMATIC WinCC Professional max. PowerTags</li> </ul> <p><b>Download <sup>1)</sup></b></p> <ul style="list-style-type: none"> <li>• SIMATIC WinCC Basic</li> <li>• SIMATIC WinCC Comfort</li> <li>• SIMATIC WinCC Advanced</li> <li>• SIMATIC WinCC Professional 512 PowerTags</li> <li>• SIMATIC WinCC Professional 4 096 PowerTags</li> <li>• SIMATIC WinCC Professional max. PowerTags</li> </ul> <p><b>WinCC flexible 2008 to WinCC V15.1</b></p> <ul style="list-style-type: none"> <li>• WinCC flexible Compact to WinCC Comfort</li> <li>• WinCC flexible Standard to WinCC Comfort</li> <li>• WinCC flexible Advanced to WinCC Advanced</li> </ul> <p><b>Download <sup>1)</sup></b></p> <ul style="list-style-type: none"> <li>• WinCC flexible Compact to WinCC Comfort</li> <li>• WinCC flexible Standard to WinCC Comfort</li> <li>• WinCC flexible Advanced to WinCC Advanced</li> </ul>
<p><b>Software Update Service (Compact Edition)</b></p> <p>The delivery items are combined. For several contracts, only 1 package with 1 data storage medium set, 1 USB flash drive with the corresponding number of licenses and the corresponding number of CoLs will be supplied.</p> <p>Delivery items to be combined must be ordered as one item.</p> <ul style="list-style-type: none"> <li>• SIMATIC WinCC Comfort</li> <li>• SIMATIC WinCC Advanced</li> <li>• SIMATIC WinCC Professional 512 PowerTags</li> <li>• SIMATIC WinCC Professional 4 096 PowerTags</li> <li>• SIMATIC WinCC Professional max. PowerTags</li> </ul> <p><b>Download <sup>1)</sup></b></p> <p>Email address required for delivery</p> <ul style="list-style-type: none"> <li>• SIMATIC WinCC Comfort</li> <li>• SIMATIC WinCC Advanced</li> <li>• SIMATIC WinCC Professional 512 PowerTags</li> <li>• SIMATIC WinCC Professional 4 096 PowerTags</li> <li>• SIMATIC WinCC Professional max. PowerTags</li> </ul>	<p><b>6AV6612-0AA00-0AM0</b></p> <p><b>6AV6613-0AA00-0AM0</b></p> <p><b>6AV2103-0DA00-0AM0</b></p> <p><b>6AV2103-0HA00-0AM0</b></p> <p><b>6AV2103-0XA00-0AM0</b></p> <p><b>6AV6612-0AA00-0AY0</b></p> <p><b>6AV6613-0AA00-0AY0</b></p> <p><b>6AV2103-0DA00-0AY0</b></p> <p><b>6AV2103-0HA00-0AY0</b></p> <p><b>6AV2103-0XA00-0AY0</b></p>	<p><b>6AV2100-3AA05-0AE5</b></p> <p><b>6AV2101-3AA05-0AE5</b></p> <p><b>6AV2102-3AA05-0AE5</b></p> <p><b>6AV2103-3DA05-0AE5</b></p> <p><b>6AV2103-3HA05-0AE5</b></p> <p><b>6AV2103-3XA05-0AE5</b></p> <p><b>6AV2100-3AA05-0AK5</b></p> <p><b>6AV2101-3AA05-0AK5</b></p> <p><b>6AV2102-3AA05-0AK5</b></p> <p><b>6AV2103-3DA05-0AK5</b></p> <p><b>6AV2103-3HA05-0AK5</b></p> <p><b>6AV2103-3XA05-0AK5</b></p> <p><b>6AV2101-4AB05-0AE5</b></p> <p><b>6AV2101-4BB05-0AE5</b></p> <p><b>6AV2102-4AA05-0AE5</b></p> <p><b>6AV2101-4AB05-0AK5</b></p> <p><b>6AV2101-4BB05-0AK5</b></p> <p><b>6AV2102-4AA05-0AK5</b></p>

<sup>1)</sup> Current information and availability regarding the new type of delivery can be found at:  
<http://www.siemens.com/tia-online-software-delivery>

<sup>2)</sup> For a period of 12 months and for a fixed price, the customer is automatically provided with all upgrades and Service Packs for each installed WinCC engineering system or option. The contract is automatically extended by a further year unless canceled at least 12 weeks prior to expiration.

Additional information is available on the Internet at:

<http://www.siemens.com/wincc-tia-portal>

## HMI Software

HMI Software in the TIA Portal  
SIMATIC WinCC (TIA Portal) Runtime

### Introduction

#### Overview

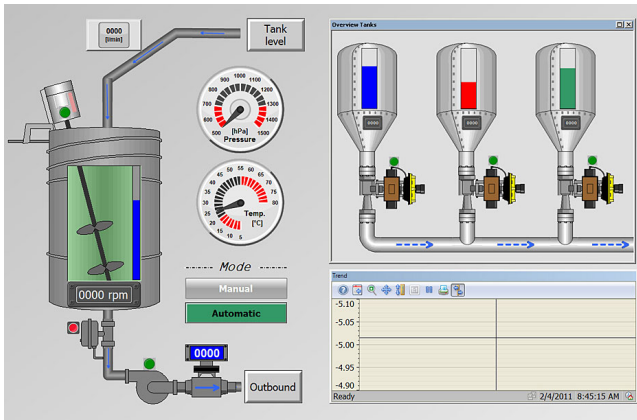

#### **SIMATIC WinCC Runtime Professional visualization software**

- PC-based operator control and monitoring system for visualization and operator control of processes, production flows, machines and plants in all sectors – from the simple single-user station through to distributed multi-user systems and cross-location solutions with web clients. WinCC Runtime Professional is the information hub for corporation-wide vertical integration.
- Industry-standard functions for signaling and acknowledging events, archiving of messages and measured values, logging of all process and configuration data, user administration, can be expanded flexibly with VB and C scripts
- Basic package expandable by means of option packages
- Also included are APIs for the Runtime to utilize the open programming interfaces

For more detailed information, refer to:

<http://www.siemens.com/wincc-professional>

#### **SIMATIC WinCC Runtime Advanced visualization software**

- PC-based operator control and monitoring solution for single-user systems directly at the machine
- Basic package for visualization, reporting and logging, user administration, can be expanded flexibly with VB scripts
- Basic package expandable by means of option packages
- Can be integrated into automation solutions based on TCP/IP networks
- Expanded service concepts with remote operation, diagnostics and administration over the intranet and Internet in combination with email communication

<http://www.siemens.com/wincc-advanced>

## Overview

PC-based operator control and monitoring system for single-user systems directly at the machine. SIMATIC WinCC Runtime Advanced is configured with the SIMATIC WinCC Advanced or SIMATIC WinCC Professional configuration software.

## Benefits

- Functions for all visualization tasks:
  - Operator functions
  - Graphics and trend displays
  - Alarm logging
  - Report system
  - Archiving (option)
  - Recipe management (option)
  - Audit Trail (option)
- Flexible runtime functionality due to Visual Basic scripts
- Service concepts with remote operation, diagnostics and administration via intranet/Internet as well as email communication increase availability (option)
- Support for simple distributed automation solutions based on TCP/IP networks at the machine-level (option)
- Part of the Totally Integrated Automation Portal
  - Direct access to the tag and message configuration of the SIMATIC controller
  - Excellent support of the new SIMATIC S7-1500 controller
    - With symbolic addressing
    - Access to the new memory-optimized data blocks
    - New alarm and diagnostics concept (incl. ProDiag)
  - Integrated diagnostic functions for increasing productivity

## Application

SIMATIC WinCC Runtime Advanced is the high-performance visualization software for simple, machine-oriented visualization tasks. It can be used as a single-user solution for all automation applications in production automation, process automation and building services automation.

SIMATIC WinCC Runtime Advanced can be used in combination with the following operator panels:

- SIMATIC Rack PC:
  - IPC347, IPC547, IPC647, IPC847
- SIMATIC Box PC:
  - IPC227, IPC427, IPC627, IPC827
- SIMATIC Panel PC:
  - IPC277, IPC477, IPC677, Panel PC Ex OG
- SIMATIC S7 Open Controller: ET 200SP Open Controller
- SINUMERIK PC: PCU 50.3, PCU 50.5
- Standard PCs with resolutions (W x H in pixels) of:
  - 4:3 format: 640 x 480, 800 x 600, 1024 x 768, 1280 x 1024, 1600 x 1200
  - Widescreen format: 800 x 480, 1280 x 800, 1366 x 768, 1440 x 900, 1680 x 1050, 1920 x 1080, 1920 x 1200, 1980 x 1080

## Design

SIMATIC WinCC Runtime Advanced is available as a software package with 128, 512, 2 048, 4 096, 8 192 and 16 384 PowerTags.

The term PowerTags is used to identify process tags and area pointers that have a process link to the controller. Tags without process links, constant limit values of tags, and messages (up to 4 000 bit-triggered messages) are also available for additional system performance. The range of functions of WinCC Runtime Advanced includes the centralized HMI components for visualizing and reporting, and it can be expanded to suit requirements and costs by using optional packages.

SIMATIC WinCC Runtime Advanced is configured with the SIMATIC WinCC Advanced or SIMATIC WinCC Professional configuration software.

## Function

### Visualization via Windows-compliant user interface

Made up of parameterizable screen objects and faceplates created on a project-specific basis:

- Numeric and alphanumeric input/output fields
- Static text and graphic display plus vector graphics
- Dynamizable graphics from HMI symbol library
- Bar graph, trend curve graph with scroll and zoom function as well as read line
- Signal-specific text and graphic lists
- Buttons and switches for operator-process communication
- Editing fields for process values (signals)
- Analog display, slider as example for further screen objects
- Project-specific faceplates created from basic objects of the system
- Graphic displays for various standard graphic formats, e.g. bitmaps, .jpg, .wmf

### Alarms and messages

- Discrete alarms and analog alarms as well as event-driven Alarm-S/Alarm-D message procedure with SIMATIC S7
- The new ProDiag alarm and diagnostics concept of the S7-1500 controller is also supported
- Freely-definable message classes for definition of acknowledgment response and display of alarm events

### Logging of alarms and process values<sup>1)</sup>

- Logging in files (e.g. CSV or TXT file) and Microsoft SQL databases
- Online evaluation of process value and alarm logs
- Evaluation of process value and alarm logs using standard Microsoft tools such as Excel

### Recipes<sup>1)</sup>

- Generation of data records for machine data or production data
- Display or entry of data records via a configurable screen object or via process screens distributed within the project
- Transmission of data records from or to the controller
- Import/export of data records from/to CSV files for further processing with other tools (e.g. MS Excel)

### Documentation of process data, alarm events, and recipes

- Time or event-driven report output
- User-definable layout

<sup>1)</sup> Option for SIMATIC WinCC Runtime Advanced; runtime licenses must be purchased separately. Additional information is available under "WinCC options".

## HMI Software

HMI Software in the TIA Portal  
SIMATIC WinCC (TIA Portal) Runtime

### WinCC Runtime Advanced

#### Function (continued)

##### **Flexible expansion of integrated system function using Visual Basic script**

##### **Language support for multilingual projects**

- Up to 32 online languages
- Language-dependent texts and graphics
- Language selection during runtime

##### **User-oriented access protection according to requirements of regulated sectors**

- Authentication with user ID and password
- User group-specific rights
- Central system-wide user administration based on SIMATIC Logon<sup>1)</sup>
- Monitoring of changes by operators in runtime operation<sup>1)</sup>
- Recording of operator actions in an Audit Trail<sup>1)</sup>

##### **Onboard controller connection to many different controllers**

- Communication via native drivers and standard OPC channel
- Simultaneous connection using several protocols: OPC client and SIMATIC HMI HTTP protocol are additive, i.e. they can be used in conjunction with other controller connections

##### **Open communication between HMI systems and with higher-level systems**

- OPC servers
  - Use of the visualization system as a data server (OPC server) for higher-level automation components, e.g. control systems or systems in the office area
  - OPC-DA server: tags, e.g. process values
- Communication between HMI systems is established on the basis of Ethernet networks, or via the intranet/Internet
  - Read and write access to tags. The WinCC Runtime Advanced or SIMATIC Panels provide other SIMATIC HMI systems or office applications with data (tags)
- Sending of emails on demand or event-driven
  - e.g. to maintenance personnel via SMTP server (Simple Mail Transfer Protocol)
  - The optional use of email/SMS gateways enables access to standard networks (external service provider required)
- System diagnostics via device-specific HTML pages. The following functions are available:
  - Starting and stopping the HMI runtime for maintenance
  - Remote access to recipe data records, passwords and information specific to the HMI system
  - Access to the HMI system files via a file explorer
  - Download of configuration data via the intranet/Internet
  - Supplement with own HTML pages

##### **WinCC Sm@rtServer for the remote control via the intranet and Internet<sup>1)</sup>**

- Display and control of process screens on remote PC or Panel
- A SIMATIC HMI system can be used to control or monitor another system remotely; entry level for client/server configurations for distributed operator stations or for solutions with head-end stations or control rooms

<sup>1)</sup> Option for SIMATIC WinCC Runtime Advanced; runtime licenses must be purchased separately. Additional information is available under "WinCC options".

#### System requirements

	SIMATIC WinCC Runtime Advanced
<b>Processor type (min.)<sup>1)</sup></b>	32-bit operating system: at least Intel® Atom™ 1.3 GHz or comparable 64-bit operating system: at least Intel® Celeron™ 1.4 GHz or comparable
<b>RAM (min.)<sup>2)</sup></b>	4 GB or more
<b>Hard disk</b>	8 GB disk space available
<b>Operating systems</b>	32-bit operating systems: <ul style="list-style-type: none"> <li>• Windows 7 Professional SP1</li> <li>• Windows 7 Enterprise SP1</li> <li>• Windows 7 Ultimate SP1</li> <li>• Windows Embedded Standard Edition 7 SP1 (SIMATIC IPC only)</li> </ul> 64-bit operating systems: <ul style="list-style-type: none"> <li>• Windows 7 Professional SP1</li> <li>• Windows 7 Enterprise SP1</li> <li>• Windows 7 Ultimate SP1</li> <li>• Windows Embedded Standard Edition 7 SP1 (SIMATIC IPC only)</li> <li>• Windows 8.1 Professional</li> <li>• Windows 8.1 Enterprise</li> <li>• Windows Embedded 8.1 Industry</li> <li>• Windows 10 Professional Version 1703</li> <li>• Windows 10 Enterprise Version 1703</li> <li>• Windows 10 Enterprise 2016 LTSC</li> <li>• Windows Server 2008 R2 Standard Edition SP1</li> <li>• Windows Server 2012 R2 Standard Edition</li> <li>• Windows Server 2016 Standard Edition</li> </ul>
<b>Optical drive</b>	DVD-ROM

<sup>1)</sup> In combination with options, more powerful systems may be required

<sup>2)</sup> The required RAM is determined primarily by the size of the graphics used.

<sup>3)</sup> Without taking archives into account.

#### Note:

In addition to WinCC, Windows also requires space on the hard disk; e.g. free storage space should be available for the swap file. The following formula has proven itself in the past:  
Size of swap file = 3 x size of RAM.

For further information, refer to your Windows documentation.

## Technical specifications

The following tables of system limitations provide assistance in estimating whether a specific project is still within the system limitations for WinCC Runtime Advanced.

The stated maximum values are not additive.

We cannot guarantee proper functioning of configurations that make full use of all system limits on the HMI devices. In addition to the limitations specified, allowances must be made for restrictions in configuration memory resources.

SIMATIC WinCC Runtime Advanced	
<b>Tags</b>	
Number of tags in the project	24 576
Number of PowerTags	128–16 384
Number of elements per array	1 600
Number of local tags	8 192
<b>Alarms</b>	
Number of alarm classes	32
Number of discrete alarms	6 000
Number of analog alarms	500
Length of an alarm in characters	80
Number of process values per alarm	8
Size of the alarm buffer	2 048
Number of queued alarm events	500
<b>Screens</b>	
Number of screens	750
Number of fields per screen	600
Number of tags per screen	400
Number of complex objects per screen <sup>1)</sup>	40
<b>Recipes</b>	
Number of recipes	1 000
Number of elements per recipe <sup>2)</sup>	2 000
User data length in KB per data record	512
Number of data records per recipe	5 000
<b>Logs</b>	
Number of logs	100
Number of entries per log (including all log segments) <sup>3)</sup>	500 000
Number of log segments	400
Cyclical trigger for tag logging	1 s
Number of tags that can be logged per log	24 576

SIMATIC WinCC Runtime Advanced	
<b>Trends</b>	
Number of trends	800
<b>Text lists and graphics lists</b>	
Number of graphic lists	500
Number of text lists	500
Number of entries per text or graphic list	3 500
Number of graphic objects	24 576
Number of text elements	40 000
<b>Scripts</b>	
Number of scripts	200
<b>Communication</b>	
Number of connections	8
Number of connections based on "SIMATIC HMI HTTP"	16
Maximum number of connected Sm@rtClients (including a service client)	4 <sup>4)</sup>
<b>Help system</b>	
Number of characters in a help text	500
<b>Languages</b>	
Number of runtime languages	32
<b>Scheduler</b>	
Time-triggered tasks <sup>5)</sup>	48
<b>User administration</b>	
Number of user groups	50
Number of user rights	32
Number of users	100

- 1) Complex objects are: Bars, sliders, symbol library, clock, and all objects from the Controls area.
- 2) When using arrays, each array element represents a recipe element
- 3) For the "segmented circular log" logging method, the number of entries for all sequence logs is valid. The product derived from the number of circular logs times the number of data records in this log may not be exceeded.
- 4) Up to three Sm@rtClients can interconnect with the Sm@rtServer on Panel PC 477.
- 5) Event-triggered tasks are not relevant for the system limits.

## HMI Software

HMI Software in the TIA Portal  
SIMATIC WinCC (TIA Portal) Runtime

### WinCC Runtime Advanced

#### Ordering data

#### Article No.

#### Article No.

##### Basic software

##### SIMATIC WinCC Runtime Advanced V15.1

Software and documentation on DVD, including options software <sup>1)</sup>  
Single license, license key on USB flash drive for

- 128 PowerTags
- 512 PowerTags
- 2 048 PowerTags
- 4 096 PowerTags
- 8 192 PowerTags
- 16 384 PowerTags

##### Download <sup>3)</sup>

Single license, software and license key download; email address required for delivery

- 128 PowerTags
- 512 PowerTags
- 2 048 PowerTags
- 4 096 PowerTags
- 8 192 PowerTags
- 16 384 PowerTags

6AV2104-0BA05-0AA0  
6AV2104-0DA05-0AA0  
6AV2104-0FA05-0AA0  
6AV2104-0HA05-0AA0  
6AV2104-0KA05-0AA0  
6AV2104-0LA05-0AA0

6AV2104-0BA05-0AH0  
6AV2104-0DA05-0AH0  
6AV2104-0FA05-0AH0  
6AV2104-0HA05-0AH0  
6AV2104-0KA05-0AH0  
6AV2104-0LA05-0AH0

##### Powerpacks

##### SIMATIC WinCC Runtime Advanced V15.1 (without version change)

Single license, license key only on USB flash drive for PowerTags from

##### Data storage medium

- 128 PT to 512 PT
- 512 PT to 2 048 PT
- 2 048 PT to 4 096 PT
- 4 096 PT to 8 192 PT
- 8 192 PT to 16 384 PT

##### Download <sup>3)</sup>

Single license, software and license key download. email address required for delivery

- 128 PT to 512 PT
- 512 PT to 2 048 PT
- 2 048 PT to 4 096 PT
- 4 096 PT to 8 192 PT
- 8 192 PT to 16 384 PT

6AV2104-2BD05-0BD0  
6AV2104-2DF05-0BD0  
6AV2104-2FH05-0BD0  
6AV2104-2HK05-0BD0  
6AV2104-2KL05-0BD0

6AV2104-2BD05-0BJ0  
6AV2104-2DF05-0BJ0  
6AV2104-2FH05-0BJ0  
6AV2104-2HK05-0BJ0  
6AV2104-2KL05-0BJ0

##### Upgrades

##### SIMATIC WinCC Runtime Advanced V11..14 to V15.1

Software and documentation on DVD, including options software  
Single license, license keys on USB flash drive for

- 128 PowerTags
- 512 PowerTags
- 2 048 PowerTags
- 4 096 PowerTags
- 8 192 - 16 384 PowerTags

##### As download <sup>3)</sup>

Single license, software and license key download. email address required for delivery

- 128 PowerTags
- 512 PowerTags
- 2 048 PowerTags
- 4 096 PowerTags
- 8 192 - 16 384 PowerTags

6AV2104-3BB05-0AE0  
6AV2104-3DD05-0AE0  
6AV2104-3FF05-0AE0  
6AV2104-3HH05-0AE0  
6AV2105-3KK05-0AE0

6AV2104-3BB05-0AK0  
6AV2104-3DD05-0AK0  
6AV2104-3FF05-0AK0  
6AV2104-3HH05-0AK0  
6AV2105-3KK05-0AK0

##### SIMATIC WinCC flexible 2008 to SIMATIC WinCC Runtime Advanced V15.1

Software and documentation on DVD, including options software  
Single license, license keys on USB flash drive for

- 128 PT to 512 PT
- 512 PT to 2 048 PT
- 2 048 PT to 4 096 PT
- 4 096 PT to 8 192 PT
- 8 192 PT to 16 384 PT

##### Download <sup>3)</sup>

Single license, software and license key download. email address required for delivery

- 128 PT to 128 PT <sup>2)</sup>
- 512 PT to 512 PT <sup>2)</sup>
- 2 048 PT to 2 048 PT <sup>2)</sup>
- 4 096 PT to 4 096 PT <sup>2)</sup>
- 8 000 PT to 8 192 PT <sup>2)</sup>

6AV2104-4BB05-0AE0  
6AV2104-4DD05-0AE0  
6AV2104-4FF05-0AE0  
6AV2104-4HH05-0AE0  
6AV2104-4KK05-0AE0

6AV2104-4BB05-0AK0  
6AV2104-4DD05-0AK0  
6AV2104-4FF05-0AK0  
6AV2104-4HH05-0AK0  
6AV2104-4KK05-0AK0

##### SIMATIC WinCC flexible Panel Options to SIMATIC WinCC (TIA Portal) Panel Options

- WinCC flexible /Audit for SIMATIC Panels to SIMATIC WinCC Audit for SIMATIC Comfort/Mobile Panels
- WinCC flexible /Sm@rtAccess for SIMATIC Panel to SIMATIC WinCC Sm@rtServer for SIMATIC Panels
- WinCC flexible /Sm@rtService for SIMATIC Panels to SIMATIC WinCC Sm@rtServer for SIMATIC Panels
- WinCC flexible/ProAgent for Panels to SIMATIC ProDiag for Comfort/Mobile Panel
- Data storage medium
- Download <sup>3)</sup>  
Single license, software and license key download. email address required for delivery

6AV2107-4XP00-0BF0  
6AV2107-4XP00-0BK0

- <sup>1)</sup> Runtime licenses for WinCC Runtime Advanced options must be purchased separately for each target system
- <sup>2)</sup> Each including 1 upgrade license to the WinCC Runtime Advanced options
- <sup>3)</sup> Current information and availability regarding the new type of delivery can be found at: <http://www.siemens.com/tia-online-software-delivery>

Additional information is available on the Internet at:

<http://www.siemens.com/wincc-advanced>

#### Overview

PC-based operator control and monitoring system for visualization and operator control of processes, production flows, machines and plants in all sectors – from the simple single-user station through to distributed multi-user systems and cross-location solutions with web clients.

SIMATIC WinCC Runtime Professional is the information hub for corporation-wide vertical integration. SIMATIC WinCC Runtime Professional is configured with the SIMATIC WinCC Professional configuration software.

#### Benefits

- Functions for all visualization tasks:
  - Operator functions
  - Graphics and trend displays
  - Alarm logging
  - Report system
  - Archiving (option)
  - Recipe management (option)
- Universally scalable
  - Expandable from single station to client-server configurations
  - Process visualization via the web with the WinCC WebNavigator
- Open standards for easy integration
  - Efficient real-time database MS SQL Server
  - Open for application modules with ActiveX controls
  - Visual Basic for Applications for individual expansions
  - OPC for cross-vendor communication
- Part of the Totally Integrated Automation Portal
  - Direct access to the tag and message configuration of the SIMATIC controller
  - Excellent support of the new SIMATIC S7-1500 controller
    - With symbolic addressing
    - Access to the new memory-optimized data blocks
    - New ProDiag alarm and diagnostics concept
  - Integrated diagnostic functions for increasing productivity

#### Application

SIMATIC WinCC Runtime Professional is designed for visualization and operator control of processes, production flows, machines and plants. With its powerful process interface, especially to the SIMATIC family, and the secure data logging, WinCC Runtime Professional enables solutions for the process control.

The sector-neutral basic system enables universal usage in all automation applications.

SIMATIC WinCC Runtime Professional can be used in combination with the following operator panels:

SIMATIC PCs:

- SIMATIC Rack PC: IPC547, IPC647, IPC847
- SIMATIC Box PC: IPC427, IPC627, IPC827
- SIMATIC Panel PC: IPC477, IPC677
- Standard PC

#### Design

SIMATIC WinCC Runtime Professional is available as a software package with 128, 512, 2 048, 4 096, 8 192, 65 536, 102 400, 153 600 and 262 144 PowerTags.

PowerTags are data points that are connected to controllers or other data sources via a WinCC Runtime Professional channel. Up to 32 alarms can be obtained from one data point. Moreover, internal tags without coupling are available for additional system performance. WinCC Runtime Professional also contains 500 archive tags. Additional archive licenses can be obtained for greater quantity structures.

#### Licenses for a multi-user configuration

The system software with the required number of PowerTags and additionally the SIMATIC WinCC Server for Runtime Professional option must be installed on the server. For the clients in the basic configuration, a SIMATIC WinCC Client for Runtime Professional license is sufficient.

#### Function

##### Visualization via Windows-compliant user interface

Made up of parameterizable screen objects and faceplates created on a project-specific basis:

- Numeric and alphanumeric input/output fields
- Static text and graphic display plus vector graphics
- Dynamizable graphics from HMI symbol library
- Bar graph, trend curve graph with scroll and zoom function as well as read line
- Signal-specific text and graphic lists
- Buttons and switches for operator-process communication
- Editing fields for process values (signals)
- Analog display, slider as example for further screen objects
- Project-specific faceplates created from basic objects of the system
- Graphic displays for various standard graphic formats, e.g. bitmaps, .jpg, .wmf, .svg

##### Alarms and messages

- Discrete alarms and analog alarms, as well as event-driven Alarm-S/Alarm-D message procedure with SIMATIC S7
- The new ProDiag alarm and diagnostics concept of the S7-1500 controller is also supported
- Freely-definable message classes for definition of acknowledgment response and display of alarm events

## HMI Software

### HMI Software in the TIA Portal SIMATIC WinCC (TIA Portal) Runtime

#### WinCC Runtime Professional

##### Function (continued)

###### Logging of messages and process values<sup>1)</sup>

- Signaling system for detecting and archiving events with display and control options according to DIN 19235
- Process logging for the acquisition, compression and storage of measured values
- Online evaluation of process value and alarm logs

###### Recipes<sup>1)</sup>

- Generation of data records for machine data or production data
- Display or entry of data records via a configurable screen object or via process screens distributed within the project
- Transmission of data records from or to the controller
- Import/export of data records for further processing with other tools (e.g. MS Excel)

###### Documentation of process data, alarm events, and recipes

- Time or event-driven report output
- User-definable layout

###### Flexible expansion by means of Visual Basic Script and ANSI-C

- Programming interfaces for individual access to data and functions of WinCC Runtime Professional and for the integration in user programs with VBA, VB Script, C-API, C-Script (ANSI-C)

###### Open communication between HMI systems and with higher-level systems

- OPC server/client  
Use of the visualization system as a data server (OPC server) for higher-level automation components such as control systems or systems in the office area
  - OPC-DA server: tags, e.g. process values
  - OPC-HDA server: logged process values
  - OPC-A&E server: Alarms
  - OPC-XML-DA server: tags, e.g. process values
  - OPC-XML-DA server: tags, e.g. process values
  - OPC-UA-DA client Tags, e.g. process values
- OLE DB server
  - Standardized and user-friendly access to WinCC log data (MS SQL Server 2005).
  - Access is via the OLE-DB Provider supplies all WinCC log data available along with the accompanying process values, as well as alarm and user texts.
  - The WinCC OLE-DB provider also supports analysis functions such as minimum, maximum, alarm hit list, etc.

- WinCC WebUX for Runtime Professional<sup>1)</sup>
  - The WebUX option enables platform and browser-independent operator control and monitoring via the Internet or the in-house intranet or LAN.
  - Installation on the terminal is unnecessary – an HTML5-compatible browser is sufficient. WebUX can then also be used on mobile terminals.
- WinCC WebNavigator for Runtime Professional<sup>1)</sup>
  - Option for SIMATIC WinCC Runtime Professional for operating and monitoring plants over the Internet, company Intranet or LAN.
  - Configuration from a web server with the SIMATIC WinCC Runtime Professional software as a single-user, client or server version and a web client that enables operator control and monitoring of a current WinCC Runtime Professional project via an Internet browser with ActiveX support. The WinCC basic system does not have to be installed on the client computer.
- WinCC DataMonitor for Runtime Professional<sup>1)</sup>
  - The WinCC DataMonitor is used for displaying and evaluating current process states and historical data on office PCs using standard tools such as Microsoft Internet Explorer or Microsoft Excel. The DataMonitor client is supported by a web server with current and historic process data and alarms. All staff ranging from machine operators to corporate managers can use the DataMonitor to obtain information.

<sup>1)</sup> Option for SIMATIC WinCC Runtime Professional; runtime licenses must be purchased separately. Additional information is available under "WinCC options".

###### Language support for multilingual projects

- Language-dependent texts and graphics
- Language selection during runtime

###### Onboard controller connection to many different controllers

- Communication via native drivers and standard OPC channel
- For communication with subordinate controls (SIMATIC protocols, PROFIBUS DP, PROFIBUS FMS, DDE and OPC server included in the scope of supply)

###### Note:

The SIMATIC Net V15 SP1 included in the delivery must be installed for communication. Before installing SIMATIC WinCC RT Professional, please always ensure compatibility with the add-on packages and options you require and use.

System prerequisites	SIMATIC WinCC Runtime Professional
Processor type (min.) <sup>1)</sup>	• Intel Celeron Dual Core 2.2 GHz (Ivy/Sandy Bridge)
RAM (min.) <sup>2)</sup>	4 GB
Free hard disk space <sup>3)</sup>	8 GB on system drive "C:"



**Function** (continued)

System prerequisites	SIMATIC WinCC Runtime Professional
<b>Operating systems</b>	32-bit operating system for WinCC Client, WebNavigator Client, DataMonitor, WebUX <ul style="list-style-type: none"> <li>• Windows 7 SP1 (Professional, Enterprise, Ultimate)</li> <li>• Windows Embedded Standard Edition 7 SP1</li> </ul> 64-bit operating systems <ul style="list-style-type: none"> <li>• Windows 8.1 (Professional, Enterprise)</li> <li>• Windows Embedded 8.1 Industry</li> <li>• Windows 7 SP1 (Professional, Enterprise, Ultimate)</li> <li>• Windows Embedded Standard Edition 7 SP1</li> <li>• Windows 10 (Professional Version 1607, Enterprise Version 1607, Enterprise 2016 LTSB, Enterprise 2015 LTSB)</li> <li>• Windows Server 2008 R2 Standard Edition SP1</li> <li>• Windows Server 2012 R2 Standard Edition</li> <li>• Windows Server 2016</li> </ul>
<b>Graphics card</b>	32 MB RAM, 24-bit color depth
<b>Network</b>	Ethernet 10 Mbps or higher
<b>Optical drive</b>	DVD-ROM

- 1) In combination with options, more powerful systems may be required  
 2) The required RAM is determined primarily by the size of the graphics used.  
 3) Without taking archives into account.

Note:

In addition to WinCC, Windows also requires space on the hard disk; e.g. free disk space should be available for the swap file.

The following formula has proven itself in the past: Size of swap file = 3 x size of RAM.

For further information, refer to your Windows documentation.

**Integration*****Integration in company-wide solutions (IT and business integration)***

WinCC Runtime Professional is strictly based on Microsoft technology, which provides for the greatest possible compatibility and integration ability.

Cross-manufacturer communication is also a simply exercise. The reason: WinCC Runtime Professional can be used as an OPC client and server, and in addition to access to current process values, it also supports standards such as OPC HDA (Historical Data Access), OPC Alarm & Events, OPC UA Data Access and OPC XML Data Access.

Just as important: Visual Basic Scripting (VBS) as an easy-to-learn, open Runtime language. If desired, professional application developers can also use ANSI-C.

WinCC Runtime Professional integrates a powerful and scalable Historian function based on the Microsoft SQL Server in the basic system.

Thus the user is given all possibilities: from high-performance archiving of current process data, to long-term archiving with high data compression, through to a central information hub in the form of a company-wide Process Historian. Open interfaces form the basis for an effective IT and business integration.

## HMI Software

### HMI Software in the TIA Portal SIMATIC WinCC (TIA Portal) Runtime

#### WinCC Runtime Professional

##### Technical specifications

The following tables of system limits provide assistance in estimating whether a specific project is still within the system limitations for WinCC Runtime Professional. The stated maximum values are not additive.

We cannot guarantee proper functioning of configurations that make full use of all system limits on the HMI devices. In addition to the limitations specified, allowances must be made for restrictions in configuration memory resources.

	SIMATIC WinCC Runtime Professional
<b>Alarms</b>	
Configurable alarms per server/single user	150,000
PowerTags per alarm line	10
User text blocks per alarm line	10
Message classes	256
Alarm types	16
Alarm priorities	17 (0...16)
<b>Alarms in Runtime</b>	
Alarms per alarm log	Unlimited <sup>1)</sup>
Alarms per short-term log list	1,000
Alarms per long-term log list	1,000 <sup>2)</sup>
Alarms per alarm display	5,000 <sup>3)</sup>
<b>Screens</b>	
Objects per screen <sup>4)</sup>	Unlimited <sup>5)</sup>
Levels per screen	32
Screens per project	Unlimited <sup>5)</sup>
Instances of fixed faceplates in a process screen	31 instances of the same picture type
Screen size in pixels	10 000 x 10 000
Nesting levels of screen objects	20

	SIMATIC WinCC Runtime Professional
<b>Recipes</b>	
Number of recipes	Unlimited <sup>5)</sup>
Number of recipe elements	500 <sup>6)</sup>
Number of recipe data records	10,000 <sup>6)</sup>
Number of views	Unlimited <sup>5)</sup>
<b>Logs</b>	
Trend views per screen	25
Trends per trend view	80
Tables per screen	25
Columns per table	12
Values per table	30,000
Logs per single-user station/server	100
Log tags per single-user station/server <sup>7)</sup>	80,000
<b>Trends</b>	
Trend views per image	25
Trends per trend view	80
<b>User administration</b>	
Number of user groups	128
Number of user rights	999
Number of users	128
<b>Configurations – Quantity structure in a multi-user system</b>	
WinCC clients in a system	32 <sup>8)</sup> <sup>9)</sup>
Web clients in a system	150 <sup>10)</sup>

<sup>1)</sup> Limited by system resources.

<sup>2)</sup> On single-user station or server or on client per server if "LongTimeArchiveConsistency" is set to "No". On single-user station, server, or client if "LongTimeArchiveConsistency" is set to "Yes".

<sup>3)</sup> On single-user station or server or on client per server.

<sup>4)</sup> The number and complexity of the objects affect the performance.

<sup>5)</sup> Limited by system resources.

<sup>6)</sup> The sum of the number of recipe elements and number of data records must not exceed a value of 1,000,000

<sup>7)</sup> Dependent on the Logging PowerPack used for the log tags. 5 000 log tags are contained in the basis version.

<sup>8)</sup> If the server is also used as an operating unit, the number of clients for this server is reduced to four.

<sup>9)</sup> Mixed configuration: 32 clients + 3 web clients

<sup>10)</sup> Mixed configuration: 50 web clients + 1 WinCC client

## Ordering data

## Article No.

## Article No.

## Basic software

**SIMATIC WinCC Runtime Professional V15.1**

For PC systems; incl. software options <sup>1)</sup>, language/script versions: en, de, fr, it, es  
Single license, on DVD incl. licensing, on USB flash drive, for:

- 128 PowerTags
  - 512 PowerTags
  - 2 048 PowerTags
  - 4 096 PowerTags
  - 8 192 PowerTags
  - 65 536 PowerTags
  - 102 400 PowerTags
  - 153 600 PowerTags
  - 262 144 PowerTags
- Incl. 500 archive tags each

Download <sup>3)</sup>

Single license, software and license key download, e-mail address required for the delivery.

- 128 PowerTags
  - 512 PowerTags
  - 2 048 PowerTags
  - 4 096 PowerTags
  - 8 192 PowerTags
  - 65 536 PowerTags
  - 102 400 PowerTags
  - 153 600 PowerTags
  - 262 144 PowerTags
- Incl. 500 archive tags each

**SIMATIC WinCC Runtime Professional ASIA V15.1**

For PC systems; incl. software options <sup>1)</sup>, language/script versions: en, zh-CHS, zh-CHT, ko, ja  
Single license, on DVD incl. licensing, for:

- 128 PowerTags
  - 512 PowerTags
  - 2 048 PowerTags
  - 4 096 PowerTags
  - 8 192 PowerTags
  - 65 536 PowerTags
  - 102 400 PowerTags
  - 153 600 PowerTags
  - 262 144 PowerTags
- Incl. 500 archive tags each

**SIMATIC WinCC Client for Runtime Professional V15.1**

- WinCC Client for Runtime Professional
- WinCC Client for Runtime Professional (as download <sup>3)</sup>)
- WinCC Client for Runtime Professional ASIA

6AV2105-0BA05-0AA0  
6AV2105-0DA05-0AA0  
6AV2105-0FA05-0AA0  
6AV2105-0HA05-0AA0  
6AV2105-0KA05-0AA0  
6AV2105-0MA05-0AA0  
6AV2105-0PA05-0AA0  
6AV2105-0RA05-0AA0  
6AV2105-0TA05-0AA0

6AV2105-0BA05-0AH0  
6AV2105-0DA05-0AH0  
6AV2105-0FA05-0AH0  
6AV2105-0HA05-0AH0  
6AV2105-0KA05-0AH0  
6AV2105-0MA05-0AH0  
6AV2105-0PA05-0AH0  
6AV2105-0RA05-0AH0  
6AV2105-0TA05-0AH0

6AV2105-0BA15-0AA0  
6AV2105-0DA15-0AA0  
6AV2105-0FA15-0AA0  
6AV2105-0HA15-0AA0  
6AV2105-0KA15-0AA0  
6AV2105-0MA15-0AA0  
6AV2105-0PA15-0AA0  
6AV2105-0RA15-0AA0  
6AV2105-0TA15-0AA0

6AV2107-0DB05-0AA0  
6AV2107-0DB05-0AH0  
6AV2107-0DB15-0AA0

## Powerpacks

**SIMATIC WinCC Runtime Professional V15.1 and SIMATIC WinCC Runtime Professional ASIA V15.1**

Single license, license key only on USB flash drives for PowerTags from

- 128 to 512 PowerTags
- 512 to 2 048 PowerTags
- 2 048 to 4 096 PowerTags
- 4 096 to 8 192 PowerTags
- 8 192 to 65 536 PowerTags
- 65 536 to 102 400 PowerTags
- 102 400 to 153 600 PowerTags
- 153 600 to 262 144 PowerTags

Download <sup>3)</sup>

Single license, software and license key download, e-mail address required for the delivery.

- 128 to 512 PowerTags
- 512 to 2 048 PowerTags
- 2 048 to 4 096 PowerTags
- 4 096 to 8 192 PowerTags
- 8 192 to 65 536 PowerTags
- 65 536 to 102 400 PowerTags
- 102 400 to 153 600 PowerTags
- 153 600 to 262 144 PowerTags

6AV2105-2BD05-0BD0  
6AV2105-2DF05-0BD0  
6AV2105-2FH05-0BD0  
6AV2105-2HK05-0BD0  
6AV2105-2KM05-0BD0  
6AV2105-2MP05-0BD0  
6AV2105-2PR05-0BD0  
6AV2105-2RT05-0BD0

6AV2105-2BD05-0BJ0  
6AV2105-2DF05-0BJ0  
6AV2105-2FH05-0BJ0  
6AV2105-2HK05-0BJ0  
6AV2105-2KM05-0BJ0  
6AV2105-2MP05-0BJ0  
6AV2105-2PR05-0BJ0  
6AV2105-2RT05-0BJ0

## Upgrades V11..14 to WinCC V15.1

**SIMATIC WinCC Runtime Professional V11..14 and SIMATIC WinCC Runtime Professional ASIA V11..V14 to V15.1**

Single license, on DVD including licensing on USB flash drive:  
The upgrades include WinCC RT Prof. upgrade licenses for the options (WebNavigator, DataMonitor, WebDiag Client, excluding WinCC Upgrade Client)

- SIMATIC WinCC RT Professional 128 PowerTags
- SIMATIC WinCC RT Professional 512 PowerTags
- SIMATIC WinCC RT Professional 2 048 PowerTags
- SIMATIC WinCC RT Professional 4 096 PowerTags
- SIMATIC WinCC RT Professional 8 192 PowerTags
- SIMATIC WinCC RT Professional 64k to 256k PowerTags
- SIMATIC WinCC Client for Runtime Professional V15.1

Download <sup>3)</sup>

Single license, software and license key download, e-mail address required for the delivery.

- SIMATIC WinCC RT Professional 128 PowerTags
- SIMATIC WinCC RT Professional 512 PowerTags
- SIMATIC WinCC RT Professional 2 048 PowerTags
- SIMATIC WinCC RT Professional 4 096 PowerTags
- SIMATIC WinCC RT Professional 8 192 PowerTags
- SIMATIC WinCC RT Professional 64k to 256k PowerTags
- SIMATIC WinCC Client for Runtime Professional V15.1

6AV2105-3BB05-0AE0  
6AV2105-3DD05-0AE0  
6AV2105-3FF05-0AE0  
6AV2105-3HH05-0AE0  
6AV2105-3KK05-0AE0  
6AV2105-3MM05-0AE0  
6AV2107-3DB05-0AE0

6AV2105-3BB05-0AK0  
6AV2105-3DD05-0AK0  
6AV2105-3FF05-0AK0  
6AV2105-3HH05-0AK0  
6AV2105-3KK05-0AK0  
6AV2105-3MM05-0AK0  
6AV2107-3DB05-0AK0

<sup>1)</sup> Runtime licenses for WinCC Runtime Professional options must be purchased separately for each target system

<sup>2)</sup> Each including 1 upgrade license to the WinCC Runtime Professional options

<sup>3)</sup> Current information and availability regarding the new type of delivery can be found at: <http://www.siemens.com/tia-online-software-delivery>

## HMI Software

HMI Software in the TIA Portal  
SIMATIC WinCC (TIA Portal) Runtime

### WinCC Runtime Professional

#### Ordering data

##### **SIMATIC WinCC Software Update Service (SUS) RT Professional** <sup>4) 5) 6)</sup>

Software Update Service for WinCC RT Professional Software

- WinCC RT Professional Client (SUS)
- WinCC RT Professional (SUS) As download <sup>3)</sup>
- WinCC RT Professional Client (SUS)
- WinCC RT Professional (SUS)

#### Article No.

**6AV2107-0DB00-0AL0**

**6AV2105-0XA00-0AL0**

**6AV2107-0DB00-0AY0**

**6AV2105-0XA00-0AY0**

#### Article No.

##### **Upgrades WinCC V7.0..V7.4 to WinCC V15.1**

##### **SIMATIC WinCC RC or RT V7.0..V7.4 to SIMATIC WinCC RT Professional V15.1 and**

##### **SIMATIC WinCC RC or RT V7.0..V7.4 ASIA to SIMATIC WinCC RT Professional ASIA V15.1**

Single license, on DVD incl. licensing on USB flash drive

- WinCC RC/RT 128 PT to WinCC Runtime Professional 128 PT<sup>2)</sup>
- WinCC RC/RT 512 PT to WinCC Runtime Professional 512 PT<sup>2)</sup>
- WinCC RC/RT 2 048 PT to WinCC Runtime Professional 2 048 PT<sup>2)</sup>
- WinCC RC/RT 8 192 PT to WinCC Runtime Professional 8 192 PT<sup>2)</sup>
- WinCC RC/RT 64k to 256k PT to WinCC Runtime Professional 64k to 256k PT<sup>2)</sup>
- WinCC RC/RT 128 / RC/RT Client to WinCC RT Professional Client

##### **Download** <sup>3)</sup>

Single license, software and license key download, e-mail address required for the delivery.

- WinCC RC/RT 128 PT to WinCC Runtime Professional 128 PT<sup>2)</sup>
- WinCC RC/RT 512 PT to WinCC Runtime Professional 512 PT<sup>2)</sup>
- WinCC RC/RT 2 048 PT to WinCC Runtime Professional 2 048 PT<sup>2)</sup>
- WinCC RC/RT 8 192 PT to WinCC Runtime Professional 8 192 PT<sup>2)</sup>
- WinCC RC/RT 64k to 256k PT to WinCC Runtime Professional 64k to 256k PT<sup>2)</sup>
- WinCC RC/RT 128 / RC/RT Client to WinCC RT Professional Client

**6AV2105-4BB05-0AE0**

**6AV2105-4DD05-0AE0**

**6AV2105-4FF05-0AE0**

**6AV2105-4KK05-0AE0**

**6AV2105-4MM05-0AE0**

**6AV2107-4DB05-0AE0**

**6AV2105-4BB05-0AK0**

**6AV2105-4DD05-0AK0**

**6AV2105-4FF05-0AK0**

**6AV2105-4KK05-0AK0**

**6AV2105-4MM05-0AK0**

**6AV2107-4DB05-0AK0**

- 1) Runtime licenses for WinCC Runtime Professional options must be purchased separately for each target system
- 2) Each including 1 upgrade license to the WinCC Runtime Professional options
- 3) Current information and availability regarding the new type of delivery can be found at: <http://www.siemens.com/tia-online-software-delivery>
- 4) Software Update Service valid for 1 year. Contract automatically extended by 1 more year unless canceled 3 months prior to expiration. According to license agreement, 1 Software Update Service must be ordered for each WinCC station
- 5) Requires the current software version.
- 6) SUS available as download.

Additional information is available on the Internet at:

<http://www.siemens.com/wincc-professional>

## Overview

### Communication – SIMATIC WinCC Runtime Advanced

WinCC Advanced is an open visualization system and offers the option of connecting the most diverse control systems.

#### Number of connectable controllers

WinCC Advanced permits the parallel coupling of up to 8 controllers.

#### Connection to third-party controllers

The following "Connection overview" table includes lists of third-party protocols and controllers which are directly supported by WinCC Advanced. Generally it is also possible to connect third-party controllers via OPC (OLE for Process Control).

Current notes and information about OPC servers from many different suppliers can be found at:

<http://www.opcfoundation.org/>

WinCC Advanced supports the standards:

- OPC Data Access 2.05a
- OPC UA Data Access 1.01
- OPC XML Data Access 1.00 (client via DCOM/XML gateway)

### Coupling overview for WinCC Runtime Advanced

Protocol	Description	PC interface
<b>SIMATIC HMI</b>		
<b>Ethernet TCP/IP (HTTP communication)</b>	HTTP communication for data exchange between SIMATIC HMI (client + server) <sup>1)</sup>	CP 1612 A2
<b>SIMATIC S7</b>		
<b>Ethernet TCP/IP (S7 communication)</b>	Channel for communication via Ethernet TCP/IP with max. 8 x SIMATIC S7 controllers S7-1200, S7-1500 S7-300, S7-400, S7-200 with CP 243-1	CP 1612 A2 CP 1613 A2 CP 1623
<b>MPI, PROFIBUS (S7 communication)</b>	Channel for communication via MPI, PROFIBUS with max. 8 x SIMATIC S7 controllers S7-1200 with CM 1243-5 (DP master), S7-1500 S7-300, S7-400, S7-200 (passive S7-200 only)	CP 5612 CP 5622 CP 5711 CP 5613 A3 CP 5623
<b>PPI (PPI protocol)</b>	Channel for communication via PPI with 1 x SIMATIC S7-200 (network operation, e.g. parallel PG possible)	CP 5612 CP 5622 CP 5711 CP 5613 A3 CP 5623
<b>Software interface (S7 communication)</b>	Channel for communication via software interface with WinAC	
<b>SINUMERIK <sup>2)</sup></b>		
<b>Ethernet TCP/IP (S7 communication)</b>	Channel for communication via Ethernet TCP/IP with SINUMERIK 840D sl	CP 1612 A2 CP 1613 A2 CP 1623
<b>MPI (S7 communication)</b>	Channel for communication via MPI with SINUMERIK 840D sl	CP 5612 CP 5622 CP 5711 CP 5613 A3 CP 5623

<sup>1)</sup> HTTP and OPC communication can be used in combination with the other couplings; regarding SIMATIC Panels that support HTTP or OPC communication, see the overview under "System interfaces (WinCC V11)".

<sup>2)</sup> "SINUMERIK Operate WinCC RT Advanced" license required; for further information, see NC 60 Catalog.

## HMI Software

HMI Software in the TIA Portal  
SIMATIC WinCC (TIA Portal) Runtime

### WinCC Runtime Communication

#### Overview (continued)

Protocol	Description	PC interface
<b>Third-party controllers (WinCC V11.0 and higher) <sup>3)</sup></b>		
<b>Allen Bradley Ethernet IP</b>	Channel for communication with max. 4 x Allen Bradley controllers via Ethernet TCP/IP with Allen Bradley Ethernet IP protocol The ControlLogix / CompactLogix, SLC500 / MicroLogix and PLC5 controllers are supported	CP 1612 A2
<b>Allen Bradley DF1</b>	Channel for communication with Allen Bradley controllers via DF1 protocol The controllers SLC500 / MicroLogix and PLC5 are supported <sup>3)</sup>	COM1/COM2
<b>Mitsubishi MC TCP/IP</b>	Channel for communication with max. 4 x Mitsubishi controllers via Ethernet TCP/IP with Mitsubishi MC TCP/IP protocol The FX3, Q, and iQ/QnUD controller series are supported	CP 1612 A2
<b>Mitsubishi FX</b>	Channel for communication with Mitsubishi controllers via FX protocol The FX1N, FX2N controllers are supported	COM1/COM2
<b>Modbus TCP/IP</b>	Channel for communication with max. 4 x Modicon controllers via Ethernet TCP/IP using the Modbus TCP/IP protocol The Quantum, Momentum, Premium, TSX Micro, Compact and M340 controllers are supported	CP 1612 A2
<b>Modbus RTU</b>	Channel for communication with Modicon controllers via the Modbus RTU protocol The Quantum, Momentum, and Compact controllers are supported	COM1/COM2
<b>Omron Link / Multi Link</b>	Channel for communication with Omron controllers via the Link/Multi protocol The CP1x, CJ1x, CJ2H, CS1x, and CP2MC controllers are supported	COM1/COM2
<b>Cross-vendor</b>		
<b>OPC client <sup>1) 4)</sup> for OPC DA, OPC UA DA, XML DA</b>	Channel for OPC communication, WinCC can acquire data from OPC server applications	CP 1612 A2
<b>OPC server for OPC DA</b>	Server applications for OPC communication; WinCC provides process data to OPC clients	CP 1612 A2

<sup>1)</sup> HTTP and OPC communication can be used in combination with the other couplings; regarding SIMATIC Panels that support HTTP or OPC communication, see the overview under "System interfaces (WinCC V11)".

<sup>2)</sup> "SINUMERIK Operate WinCC RT Advanced" license required; for further information, see NC 60 Catalog.

<sup>3)</sup> For detailed information regarding supported controllers, see "System interfaces (WinCC V11)".

<sup>4)</sup> Application note:  
Parallel use of the OPC client channel allows, for example, connection to an SNMP OPC server for visualization of the data present there.  
The SNMP OPC server enables monitoring of any network components (e.g. switches) that support the SNMP protocol.  
Further information can be found under SIMATIC NET communications systems/SNMP OPC server.

**Overview** (continued)**Communication – SIMATIC WinCC Runtime Professional**

WinCC Professional is an open process visualization system and offers the option of connecting the most diverse control systems.

Released communication software

Only communication software with the listed (or higher) product versions should be used. Corresponding SIMATIC NET upgrades are available for the upgrading of older versions.

Number of connectable controllers

With CP 1613 A2/CP 1623, a maximum of 64 S7 controllers can be connected via Industrial Ethernet; with CP 5612/CP 5622 a maximum of 8 and with CP 5613 A3 a maximum of 44 S7 controllers via PROFIBUS. With approx. 10 or more controllers, the use of Industrial Ethernet is recommended.

Client-server communication

Communication between the clients and the server is implemented using the TCP/IP protocol. The construction of a separate PC-LAN is recommended. For small projects with correspondingly small message frame advent, a SIMATIC NET Industrial Ethernet can be used for both process communication (WinCC/server ↔ PLC) and for PC-PC communication (WinCC/client ↔ WinCC/server):

Connection to third-party controllers

The following "Connection overview" table includes lists of third-party protocols and controllers which are directly supported by WinCC Professional. Generally it is also possible to connect third-party controllers via OPC (OLE for Process Control).

Current notes and information about OPC servers from many different suppliers can be found at:

<http://www.opcfoundation.org/>

WinCC Professional supports the standards:

- OPC Data Access 2.05a
- OPC Data Access 3.00
- OPC UA Data Access 1.01
- OPC XML Data Access 1.00
- OPC HDA 1.20
- OPC A&E 1.10

**Coupling overview for WinCC Runtime Professional**

Protocol	Description	PC interface
<b>SIMATIC S7</b>		
<b>SIMATIC S7</b>	Protocol Suite with channel units for communication with SIMATIC S7 via <ul style="list-style-type: none"> <li>• Ethernet TCP/IP (S7 communication) to S7-1200, S7-1500, S7-300, S7-400</li> <li>• MPI, PROFIBUS (S7 communication) to S7-1200 with CM 1243-5 (DP master), S7-1500, S7-300, S7-400</li> <li>• Software interface (S7 communication) to Win AC</li> </ul>	CP 5612 CP 5622 CP 5711 CP 5613 A3 CP 5623
<b>Non-Siemens controllers (WinCC V11.0 and higher)</b>		
<b>Allen Bradley Ethernet IP</b>	Channel for communication with Allen Bradley controllers via Ethernet TCP/IP with Ethernet IP protocol The ControlLogix / CompactLogix, SLC500 / MicroLogix, and PLC5 controllers are supported	CP 1612 A2
<b>Mitsubishi MC TCP/IP</b>	Channel for communication with Mitsubishi controllers via Ethernet TCP/IP with Mitsubishi MC TCP/IP protocol The FX3, Q, and iQ/QnUD controller series are supported	CP 1612 A2
<b>Modbus TCP/IP</b>	Channel for communication with Modicon controllers via Ethernet TCP/IP using the Modbus TCP/IP protocol The Quantum, Momentum, Premium, TSX Micro, Compact and M340 controllers are supported	CP 1612 A2
<b>Cross-vendor</b>		
<b>OPC client <sup>1)</sup> for OPC DA, OPC XML DA</b>	Channel for OPC communication, WinCC can acquire data from OPC server applications	CP 1612 A2
<b>OPC server for OPC DA, OPC UA DA, OPC XML DA, OPC A&amp;E, OPC HDA</b>	Server applications for OPC communication; WinCC provides process data to OPC clients	CP 1612 A2

<sup>1)</sup> Application note:  
Parallel use of the OPC client channel allows, for example, connection to an SNMP OPC server for visualization of the data present there. The SNMP OPC server enables monitoring of any network components (e.g. switches) that support the SNMP protocol. Further information can be found under SIMATIC NET communications systems/SNMP OPC server.

# HMI Software

HMI Software in the TIA Portal  
SIMATIC WinCC (TIA Portal) Runtime

## WinCC Runtime Communication

### Overview (continued)

#### Communications examples

3

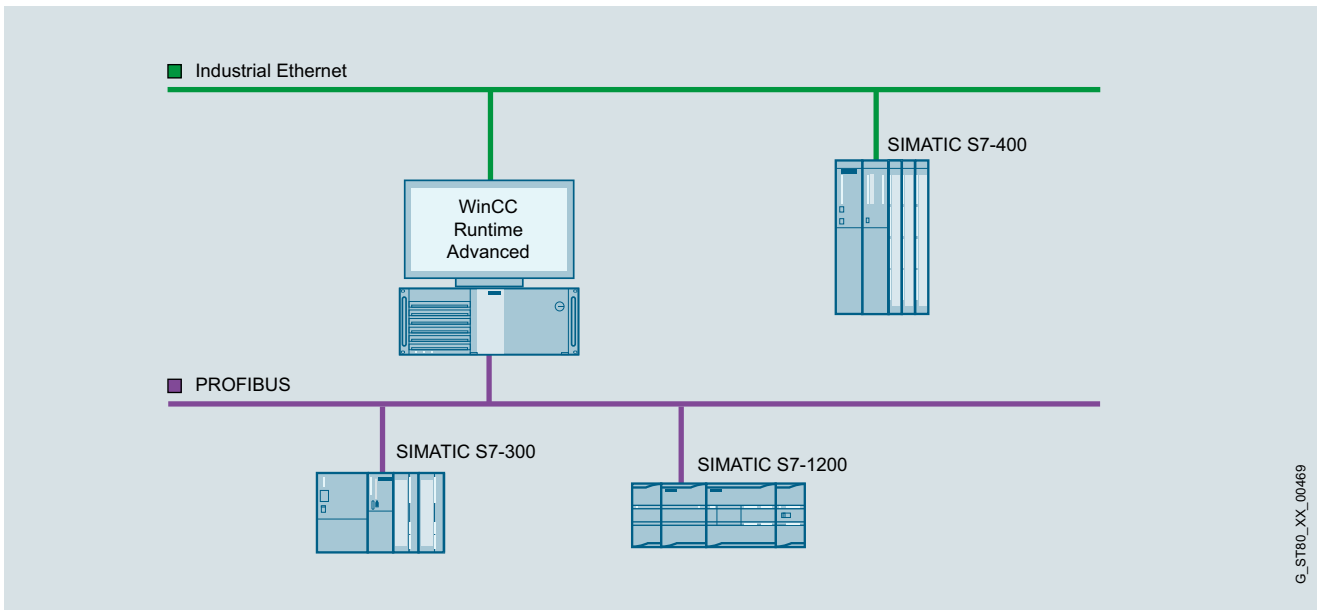

G\_ST80\_XX\_00469

WinCC Runtime Advanced single-user system

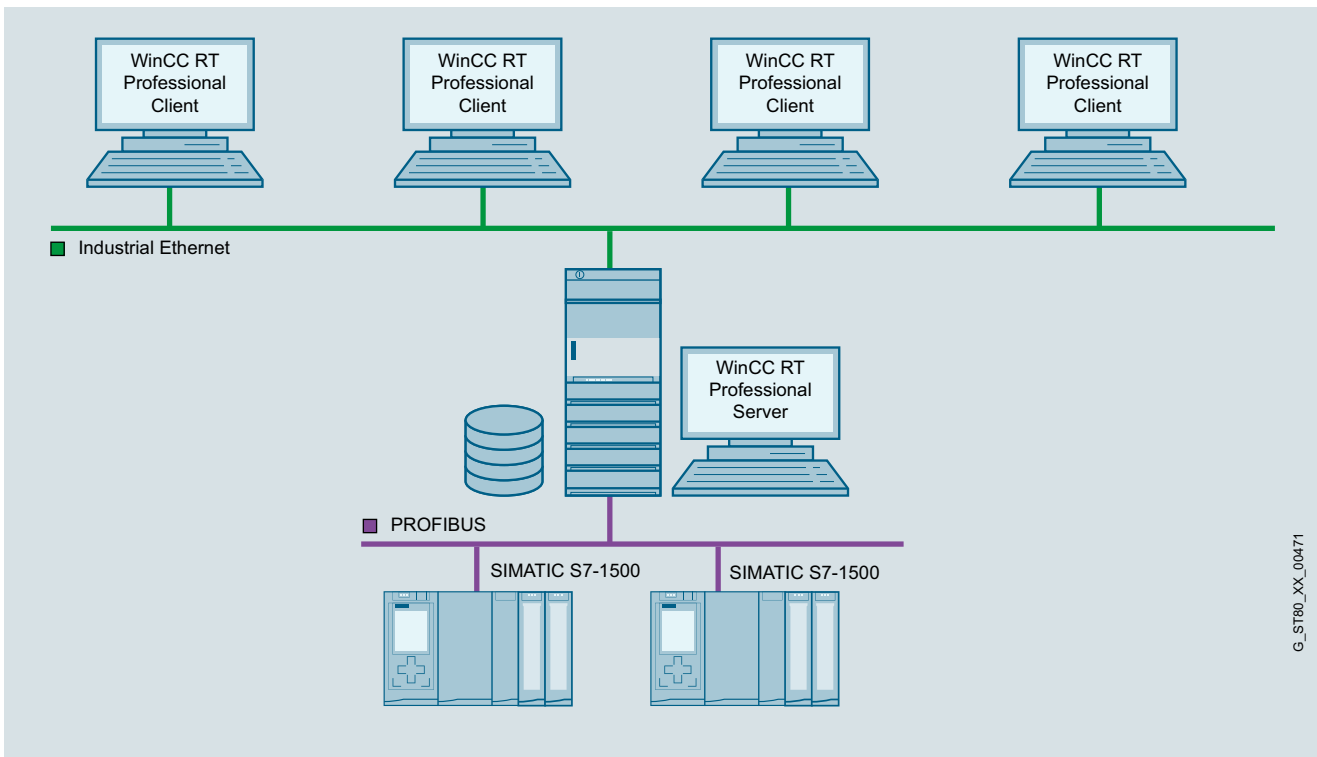

G\_ST80\_XX\_00471

WinCC Runtime Professional multi-user system with operable server



## Overview (continued)

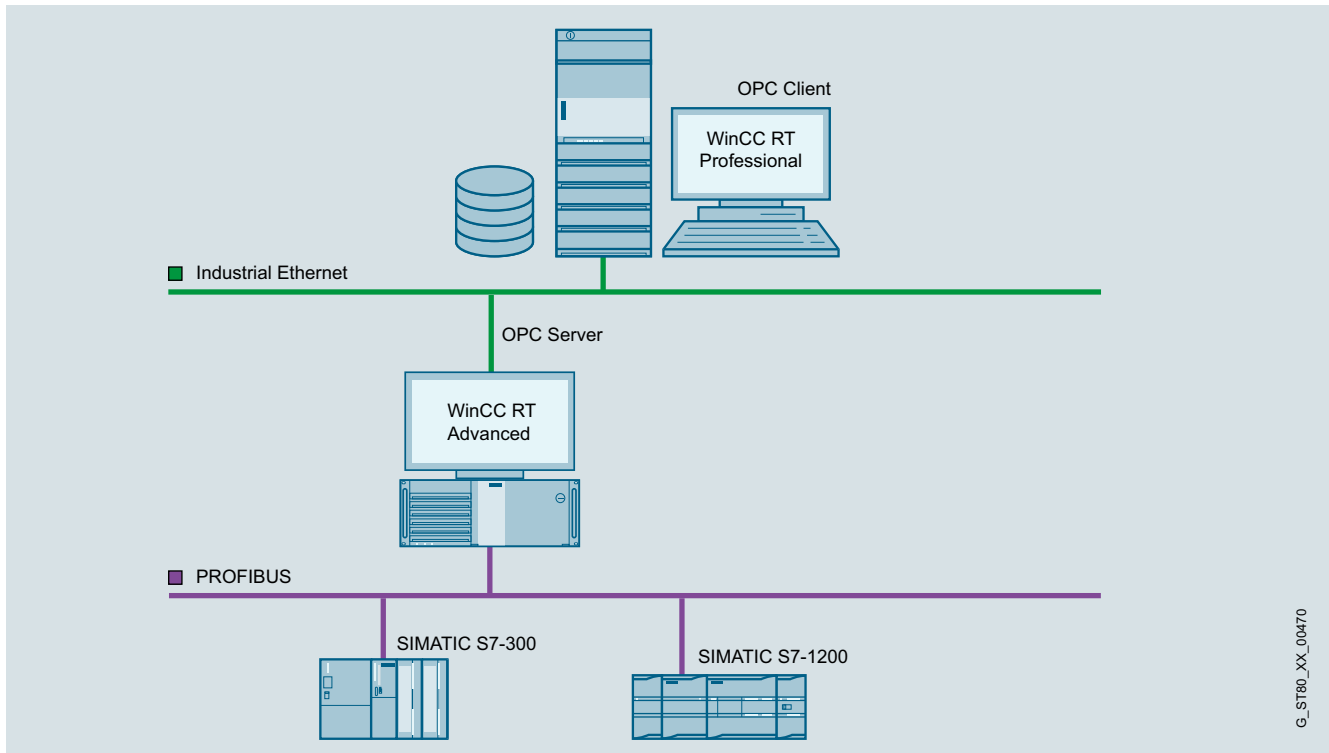

OPC coupling

## Ordering data

### SIMATIC WinCC (TIA Portal) Communication via Industrial Ethernet TCP/IP

#### CP 1612 A2

PCI card (32-bit) for connecting a programming device or PC to Industrial Ethernet (10/100/1000 Mbps); with RJ45 connection via SOFTNET-S7 and SOFTNET-PG.

Software requirement:  
WinCC Runtime Advanced:  
No further installation is required (SOFTNET-S7)

WinCC Runtime Professional:  
SOFTNET-S7 Lean (maximum of 8 connections) or SOFTNET-S7 (maximum of 64 connections) must be installed (SOFTNET-S7 Lean is included in the scope of delivery of WinCC Runtime Professional)

## Article No.

**6GK1161-2AA01**

## Article No.

### SIMATIC NET SOFTNET-IE S7 V15

Software for S7 and S5-compatible communication, incl. OPC server, PG/OP communication and NCM PC, up to 64 connections, single license for 1 installation, runtime software, software and electronic manual on CD-ROM, license key on USB stick, Class A

- Single license for 1 installation
- Upgrade package for SIMATIC NET from Edition 2006

**6GK1704-1CW15-0AA0**  
**6GK1704-1CW00-3AE0**

### SOFTNET-IE S7 Extended V15

Software for S7-, S5-compatible communication, OPC; PG/OP communication, proj. SW up to 255 connections (S7) or 512 connections (S7-1200/S7-1500); single license for 1 installation

**6GK1704-1BW15-0AA0**

## HMI Software

HMI Software in the TIA Portal  
SIMATIC WinCC (TIA Portal) Runtime

### WinCC Runtime Communication

#### Ordering data

##### SIMATIC NET SOFTNET-IE S7 LEAN V15

(included in the scope of delivery of WinCC Runtime Professional)

Software for S7-compatible and S5-compatible communication incl. OPC server, PG/OP communication and NCM PC, up to 8 connections, single license for one installation of runtime software, software and electronic manual on CD-ROM, license key on USB stick; Class A

- Single license for 1 installation
- Upgrade package for SIMATIC NET from Edition 2006

#### Article No.

**6GK1704-1LW15-0AA0**  
**6GK1704-1LW00-3AE0**

##### SIMATIC NET HARDNET-IE S7 V15

Software for S7, open communication; OPC, PG/OP communication, project software; up to 120 connections; single license for one installation of runtime software, software and electronic manual on DVD; license key on USB stick; Class A

- Single license for 1 installation
- Upgrade package for SIMATIC NET from Edition 2006

**6GK1716-1CB15-0AA0**  
**6GK1716-1CB00-3AE0**

##### CP 1623

PCI Express X1 card (32-bit) for connection of PG/PC to Industrial Ethernet (communications software must be ordered separately)

**6GK1162-3AA00**

#### Communication via PROFIBUS

##### USB A2 PC adapter

Can be used under Windows XP, Windows 7 32/64-bit

**6GK1571-0BA00-0AA0**

##### CP 5612

PCI card (32-bit) for connecting a PG/PC to PROFIBUS (communications software included in the WinCC basic package)

**6GK1561-2AA00**

##### CP 5622

PCI Express X1 card (32-bit) for connection of PG/PC to PROFIBUS (communications software included in WinCC basic package)

**6GK1562-2AA00**

##### CP 5711

USB adapter (USB V2.0) for connecting a PG/notebook to PROFIBUS or MPI (communications software included in WinCC Basic package)

**6GK1571-1AA00**

##### CP 5613 A3

PCI Card (32-bit) for connecting a PC to PROFIBUS (communications software must be ordered separately)

**6GK1561-3AA02**

##### CP 5623

PCI Express X1 card (32-bit) for connection of PG/PC to Industrial Ethernet (communications software must be ordered separately)

**6GK1562-3AA00**

## Overview

### **Options for SIMATIC Panels, SIMATIC WinCC Runtime Advanced and SIMATIC WinCC Runtime Professional**

#### SIMATIC ProDiag

- Fully-integrated TIA solution for machine and plant diagnostics
- Saves the need for programming diagnostics in the CPU during the engineering phase and provides support for troubleshooting directly on the HMI without an engineering system using diagnostic overviews and PLC code

#### SIMATIC Logon

- Creates user administration on a central computer to which one or more WinCC stations can be connected over Ethernet.
- With each user logon/logoff on one of the connected stations, SIMATIC Logon checks whether a user password has been created and that the required privileges exist.
- SIMATIC Logon supports the user in combination with the Audit option in meeting requirements in accordance with FDA 21 CFR Part 11 and EU178.

### **Options for SIMATIC WinCC Runtime Advanced and SIMATIC WinCC Runtime Professional**

#### SIMATIC WinCC Logging

- Logging of messages and process values
- Online evaluation of process value logs and alarm logs
- Evaluation of process value and alarm logs using standard MS tools such as Excel

#### SIMATIC WinCC Recipes

- Generation and management of data records for machine or production data
- Display or entry of data records via a configurable screen object or via process pictures distributed within the project
- Transmission of data records from or to the controller
- Import/export of data records for further processing with other tools (e.g. MS Excel)

### **Options for SIMATIC Panels and SIMATIC WinCC Runtime Advanced**

#### SIMATIC WinCC Audit

- Recording of operator actions in an audit trail
- Electronic signature for important user actions relevant to production
- Audit supports users in meeting special quality requirements, e.g.
  - Production plants requiring validation according to FDA 21 CFR Part 11
  - In respect of traceability according to EU 175/2002 (EU directive)

#### SIMATIC WinCC Sm@rtServer

- Flexible solution for location-independent access to HMI systems
- Remote maintenance of machines and plants via the Internet/intranet
- Reduced downtimes for machines and plants due to direct remote access
- Flexible solution for location-independent access to machines and plants

### **Options for SIMATIC WinCC Runtime Professional**

#### SIMATIC WinCC DataMonitor

- Display and analysis of current process states and historical data on office PCs with standard tools.
- Information can be individually compiled online during runtime via the Internet/intranet.

#### WinCC IndustrialDataBridge for WinCC Runtime Professional (V13 SP1 and higher)

Using the SIMATIC WinCC IndustrialDataBridge, communication links between different data sources and data targets can be created by means of simple configuration/parameter assignment. The WinCC IndustrialDataBridge can either be integrated into WinCC or used as a stand-alone application (not in conjunction with WinCC).

#### SIMATIC Information Server 2014 SP3

The SIMATIC Information Server 2014 SP3 is an open, web-based reporting system for interactive areas. Reports can be used in Internet Explorer, for Excel, Word or PowerPoint, as well as for Adobe Reader (pdf).

The SIMATIC Information Server has access to archived process values and messages, and can be used either directly in conjunction with WinCC / WinCC/RT Professional / PCS7 OS as well as with SIMATIC Process Historian 2014.

For more detailed information on the SIMATIC Information Server and Article No.'s, see SCADA System SIMATIC WinCC.

## HMI Software

### HMI Software in the TIA Portal

#### SIMATIC WinCC (TIA Portal) options

##### Overview (continued)

###### SIMATIC Process Historian 2014

The SIMATIC Process Historian 2014 is a powerful, long-term archive server solution that stores the WinCC process values and messages in a central database. The system offers full scalability for performance and scope. It records and stores data from one or more WinCC, WinCC/RT Professional and PCS 7 projects. The number of connected single stations, servers, or redundant server pairs is unrestricted. SIMATIC Process Historian is designed for use throughout your plant, and is positioned below the corporate management level (ERP, MES).

For more detailed information on the SIMATIC Process Historian and Article No.'s, see SCADA System SIMATIC WinCC.

###### SIMATIC WinCC Redundancy

For configuring a high-performance, fail-safe, client-server system. One WinCC/Redundancy package is required for each redundant pair of servers.

###### SIMATIC WinCC Server and SIMATIC WinCC Client

For setting up a high-performance client-server system

- A number of coordinated HMI stations can be operated in a single group with networked automation systems
- Client/server solution:
  - One server supplies up to 32 connected clients with process and archive data, messages, screens and reports.

###### SIMATIC WinCC WebNavigator

- Operator control and monitoring of plants via the Internet or the in-house intranet/LAN
- Web Client permits the operator control and monitoring of a current WinCC Runtime Professional project via an Internet browser with ActiveX support

###### SIMATIC WinCC WebUX

- Mobile operator control and monitoring via the Internet or the in-house intranet/LAN, using commercially available mobile devices.
- Platform and browser can be used independently on HTML5-capable and SVG-capable data terminal equipment without installation on the client.

##### Overview of the individual options

Options	WinCC RT Advanced	WinCC RT Professional	SIMATIC Panels
<b>SIMATIC ProDiag</b>	•	•	•
<b>SIMATIC Logon</b>	•	•	•
<b>WinCC Logging</b>	•	•	• 1)
<b>WinCC Recipes</b>	•	•	• 1)
<b>WinCC Audit</b>	•	-	•
<b>WinCC Sm@rtServer</b>	• 1)	-	• 1)
<b>WinCC DataMonitor</b>	-	•	-
<b>WinCC IndustrialDataBridge</b>	-	•	-
<b>SIMATIC Information Server</b>	-	•	-
<b>SIMATIC Process Historian</b>	-	•	-
<b>WinCC Redundancy</b>	-	•	-
<b>WinCC Server/WinCC Client</b>	-	•	-
<b>WinCC WebNavigator</b>	-	•	-
<b>WinCC WebUX</b>	-	•	-

- possible

<sup>1)</sup> integrated in basic system

<http://www.siemens.com/wincc-tia-portal-options>

## Overview

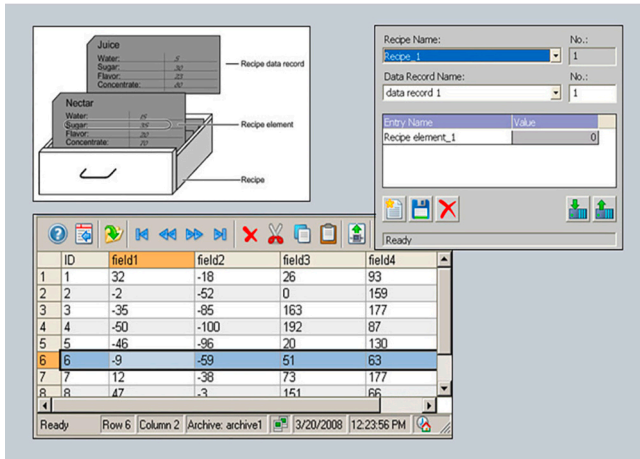

- Option for SIMATIC WinCC Runtime Advanced and WinCC Runtime Professional for managing data records in recipes that contain related machine or production data
- The data in a data set can be transferred, for example, from the control unit to the PLC to switch production to a different product variant
- Licensing:
  - SIMATIC Panels / Multi Panels / Comfort Panels: No license is required.
  - WinCC Runtime Advanced: One license is required per operator station
  - WinCC Runtime Professional: A license is only required on the server (or single-user system).

## Benefits

- Generation and management of machine parameters and production data on the basis of data records, and exchange with the automation device, e.g. with the machine.
- Clear tabular representation of the data elements with the aid of a configurable screen object, or depiction in technological relationships across several process screens.
- Simple operator guidance through standard functions.
- Export/import of data records for further processing with other tools (e.g. MS Excel)

## Function

- Input of data records (e.g. operating parameters of a machine, production data for a plastics machine) on the HMI device as well as their storage and transfer to the control
- Display or entry of data records via a configurable screen object or via several process screens distributed within the project
- The data record elements are coupled with the process via a direct tag connection
- Transmission of data records from or to the controller
- Powerful interfaces enable a synchronized data exchange with the controller.
- Storage of data records on local data carriers or on remote data servers via networks
- Logging of data records, e.g. as batch report/shift report
- User-friendly and flexible management of data records by powerful standard functions

The recipes and the associated data records are created using a separate, user-friendly WinCC Engineering editor and data is pre-assigned to them. A configurable table object is used for displaying the data at runtime. Furthermore, the individual data record elements can also be displayed directly based on standard input/output fields across several process screens. In this way, the data in technological views can be presented clearly to the operator.

Import and export functions support the importing and exporting of data via external applications (e.g. MS Excel).

## HMI Software

HMI Software in the TIA Portal  
SIMATIC WinCC (TIA Portal) options

### WinCC Recipes

#### Technical specifications

	WinCC Recipes for Runtime Advanced
	The values specified are maximum values
Number of recipes	1 000
Number of elements per recipe <sup>1)</sup>	2 000
User data length in KB per data record	256
Number of data records per recipe	5 000

	WinCC Recipes for Runtime Professional
	The values specified are maximum values
Number of recipes	1 000 <sup>2)</sup>
Number of elements per recipe <sup>1)</sup>	500 <sup>3)</sup>
User data length in KB per data record	3 000 <sup>3)</sup>
Number of data records per recipe	3 000 <sup>2)</sup>

<sup>1)</sup> When using arrays, each array element represents a recipe element

<sup>2)</sup> Limited by system resources.

<sup>3)</sup> The product of the number of recipe elements and the number of data records must not exceed a value of 320 000.

#### Ordering data

#### Article No.

##### SIMATIC WinCC Recipes for Runtime Advanced <sup>4)</sup>

- Single license, license key only on USB flash drive
- As download <sup>5)</sup>  
Single license, license key download only  
Email address required for delivery

6AV2107-0JA00-0BB0

6AV2107-0JA00-0BH0

##### SIMATIC WinCC Recipes + Logging for Runtime Advanced <sup>4)</sup>

- Single license, license key only on USB flash drive
- As download <sup>5)</sup>  
Single license, license key download only  
Email address required for delivery

6AV2107-0HA00-0BB0

6AV2107-0HA00-0BH0

##### SIMATIC WinCC Recipes for Runtime Professional <sup>4)</sup>

- Single license, license key only on USB flash drive
- As download <sup>5)</sup>  
Single license, license key download only  
Email address required for delivery

6AV2107-0JB00-0BB0

6AV2107-0JB00-0BH0

<sup>4)</sup> One license is required for each operator console. A license is not required for the engineering system for configuring the runtime option.

<sup>5)</sup> Current information and availability regarding the new delivery form can be found at: <http://www.siemens.com/tia-online-software-delivery>

#### More information

More information is available at:

<http://www.siemens.com/wincc-recipes-tia-portal>

## Overview

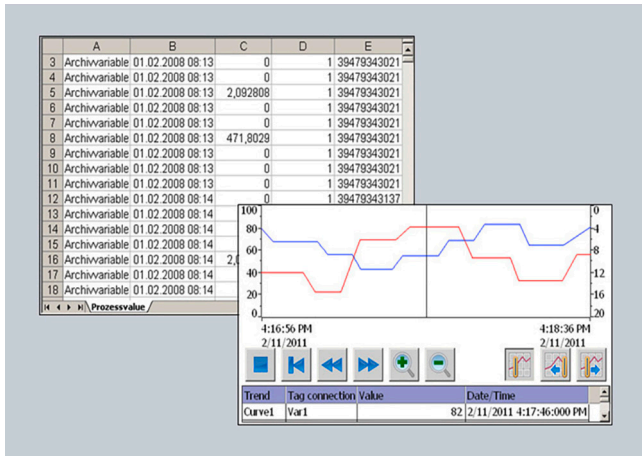

- Option for SIMATIC WinCC Runtime Advanced and WinCC Runtime Professional for logging process values and alarms
- Logging of process values and alarms supports the acquisition and processing of process data from an industrial plant or machine. Evaluation of the logged process data provides information about the operating states of the plant or machine
- Licensing:
  - SIMATIC Panels / Multi Panels / Comfort Panels: No license is required.
  - WinCC Runtime Advanced: One license is required per operator station
  - WinCC Runtime Professional: 500 Logging Tags are already included in the basic package  
The number of Logging Tags can be increased by means of additional licenses

## Benefits

- Alarm and process value logs enable predictive diagnostics, which avoids downtimes
- Early detection of danger and fault conditions
- Increase of the product quality and the productivity thanks to regular analysis of the alarm and process value logs

## Application

- Transfer of the logs for evaluation and long-term archiving
- Detection of recurring error states
- Optimization of maintenance cycles
- Ensuring quality standards
- Quality assurance and checking the utilization of production sequences
- Documentation of process sequences

## Function

- Time-controlled as well as manual or process-controlled swapping out of process data and alarms for long-term archiving
- During runtime, swapped out data are read in and selectively analyzed using WinCC Runtime Professional
  - Presentation and evaluation of archived process data based on a configurable trend display.  
Reading of the values is facilitated by a read line.
  - Presentation and evaluation of archived alarms based on a configurable alarm view.
  - User-friendly navigation in the logs
- External evaluation of the logs using MS standard tools
- Various log types are supported: sequence and circular logs
- Logging of process values and alarms on external, Windows-supported storage media
  - SIMATIC Panels and WinCC Runtime Advanced: CSV files, RDB files, Microsoft SQL Server via ODBC
  - WinCC Runtime Professional: Microsoft SQL Server 2005
- Powerful standard functions permit user-friendly and flexible utilization of the logs

## HMI Software

HMI Software in the TIA Portal  
SIMATIC WinCC (TIA Portal) options

### WinCC Logging

#### Technical specifications

	<b>WinCC Logging for Runtime Advanced</b>
	The values specified are maximum values
Number of logs	100
Archivable data	Process values, alarms
Cyclical trigger for archiving process values (variables)	1 s
Max. number of entries per log (incl. sequence log)	500.000 <sup>1)</sup>
Log types	Circular logs, sequence logs (max. 400 per log)
Data storage format	CSV (Comma Separated Variable), RDB (Runtime Data Base), Microsoft SQL data base (data base not included in scope of delivery)

	<b>WinCC Logging for Runtime Professional</b>
	The values specified are maximum values
Number of logs per single-user station/server	100
Archivable data	Process values, alarms
Measured values per second, max.	Server/single-user station: 5 000 per sec.
Log tags per single-user station/server	8.000 <sup>2)</sup>
Log types	Circular log with and without long-term logging
Data storage format	Microsoft SQL 2008 database

<sup>1)</sup> Dependent on memory medium used

<sup>2)</sup> Dependent on the Logging PowerPack used for the log tags. 500 log tags are contained in the basis version.

#### Ordering data

#### Article No.

##### **SIMATIC WinCC Logging for Runtime Advanced <sup>1)</sup>**

- Single license, license key only on USB flash drive
- As download <sup>4)</sup>  
Single license, license key download only  
Email address required for delivery

**6AV2107-0GA00-0BB0**

**6AV2107-0GA00-0BH0**

##### **SIMATIC WinCC Recipes + Logging for Runtime Advanced <sup>3)</sup>**

- Single license per option, license key only on USB flash drive
- As download <sup>4)</sup>  
Single license, license key download only  
Email address required for delivery

**6AV2107-0HA00-0BB0**

**6AV2107-0HA00-0BH0**

##### **SIMATIC WinCC Logging for Runtime Professional 1500 Logging Tags**

- Single license, license key only on USB flash drive
- As download <sup>4)</sup>  
Single license, license key download only  
Email address required for delivery

**6AV2107-0GB00-0BB0**

**6AV2107-0GB00-0BH0**

##### **SIMATIC WinCC Logging for Runtime Professional 5 000 logging tags**

- Single license, license key only on USB flash drive
- As download <sup>4)</sup>  
Single license, license key download only  
Email address required for delivery

**6AV2107-0GD00-0BB0**

**6AV2107-0GD00-0BH0**

##### **WinCC Logging for Runtime Professional Powerpack 1 500 -> 5 000 logging tags**

- Single license, license key only on USB flash drive
- As download <sup>4)</sup>  
Single license, license key download only  
Email address required for delivery

**6AV2107-2GD00-0BD0**

**6AV2107-2GD00-0BJ0**

##### **WinCC Logging Upgrade for SIMATIC WinCC Archives V7.0 (10 licenses)**

- Single license per option, license key only on USB flash drive
- As download <sup>4)</sup>  
Single license, license key download only  
Email address required for delivery

**6AV2107-4GX00-0BF0**

<sup>3)</sup> One license is required for each operator console. A license is not required for the engineering system for configuring the runtime option.

<sup>4)</sup> Current information and availability regarding the new delivery form can be found at: <http://www.siemens.com/tia-online-software-delivery>

#### More information

More information is available at:

<http://www.siemens.com/wincc-logging-tia-portal>



## Overview

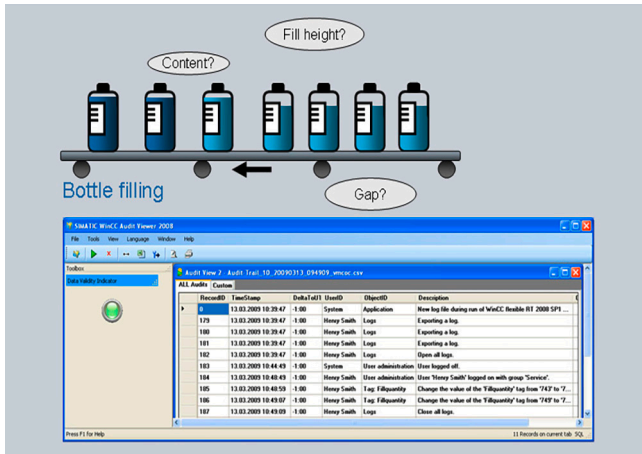

- Option for SIMATIC WinCC Runtime Advanced as well as SIMATIC Panels for recording operations in an audit trail, and electronic signature
- The audit trail is furnished with a security mechanism that displays subsequent manipulations.
- A user-friendly configuration function, which is included as standard in WinCC, is used to define the following:
  - Which user actions should be recorded in the audit trail during runtime
  - Which important operator actions during execution time require electronic signature/comments
- Available for the following SIMATIC HMI systems:
  - Comfort Panels
  - Mobile Panels
  - TP/OP 277
  - MP 277
  - MP 377
  - WinCC Runtime Advanced
- Licensing:
  - A license for SIMATIC WinCC Logging and SIMATIC WinCC Audit is required for every operator control unit (panel or PC).

## Benefits

- Audit supports the user in meeting special quality requirements, e.g.
  - Production plant requiring validation according to 21 CFR Part 11 FDA <sup>1)</sup>
  - In respect of traceability according to EU 175/2002 <sup>2)</sup>
- The entries in the audit trail are uniquely assigned to users. This means that responsibilities are clearly identifiable.
- The audit trail, stored as a CSV file <sup>3)</sup>, can be checked via a security mechanism to find out if subsequent changes have been made.
- For particularly important user actions, e.g., starting production or loading new recipes, electronic signatures and comments can be configured and then called up and logged during runtime.

<sup>1)</sup> The FDA (Food and Drug Administration) is the American public health body

<sup>2)</sup> 21 CFR Part 11- law on plant validation

<sup>3)</sup> CSV Comma Separated Values

## Technical specifications

WinCC Audit	
Storage location for Audit Trail when used on the Panel	Plug-in Flash memory card or via Ethernet in the higher-level PC
Storage location for Audit Trail when using WinCC Runtime Advanced	Local hard disk or via Ethernet in the higher-level PC
Execution platform	
SIMATIC Panels	Mobile Panel 277, TP/OP 277
SIMATIC Multi Panels	MP 277, MP 377
SIMATIC Comfort Panels	all
PC systems	SIMATIC WinCC Runtime Advanced

## Ordering data

## Article No.

### SIMATIC WinCC Audit for SIMATIC Comfort/Mobile Panels

- Single license, license key only on USB flash drive
- Download <sup>4)</sup>
- Single license, license key download only
- Email address required for delivery

**6AV2107-ORP00-0BB0**

**6AV2107-ORP00-0BH0**

### SIMATIC WinCC Audit for Runtime Advanced <sup>5)</sup>

- Single license, license key only on USB flash drive
- Download <sup>4)</sup>
- Single license, license key download only
- Email address required for delivery

**6AV2107-ORA00-0BB0**

**6AV2107-ORA00-0BH0**

<sup>4)</sup> Current information and availability regarding the new type of delivery can be found at: <http://www.siemens.com/tia-online-software-delivery>

<sup>5)</sup> The following license is also required: SIMATIC WinCC Logging for Runtime Advanced

## More information

More information is available at:

<http://www.siemens.com/wincc-audit-tia-portal>

## HMI Software

HMI Software in the TIA Portal  
SIMATIC WinCC (TIA Portal) options

### SIMATIC Logon

#### Overview

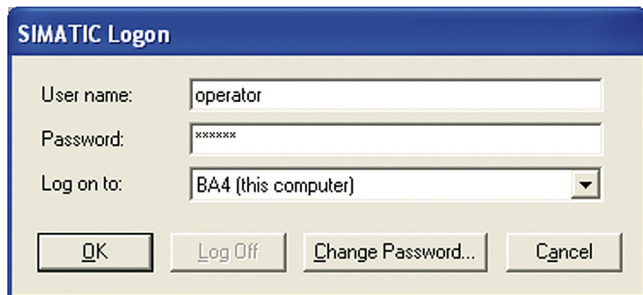

- Option for connecting SIMATIC Panels and PCs with SIMATIC WinCC Runtime Advanced as well as WinCC Runtime Professional to a central user administration.
- Creates user administration on a central computer to which one or more panels or WinCC stations can be connected over Ethernet.
- With each logging-on/off of a user on one of the connected stations, SIMATIC Logon checks whether a user password has been created and that the required privileges exist.

#### **SIMATIC Logon for Panels and WinCC Runtime Advanced**

- All users of the SIMATIC Panels or WinCC Runtime Advanced stations can be managed plant-wide from a central location
- Supports the user in combination with the Audit option in meeting requirements in accordance with FDA 21 CFR Part 11 and EU178.
- Licensing:  
SIMATIC Logon (basic license) and SIMATIC Logon Remote Access (3-pack license) for the connection of 3 panels or WinCC Runtime Advanced stations to a central user administration. Additional stations can be connected by using further SIMATIC Logon Remote Access licenses (3-pack/10-pack).

#### **SIMATIC Logon for WinCC Runtime Professional**

- All users of WinCC Runtime Professional can be managed plant-wide from a central location.
- The central user management with SL utilizes Windows mechanisms and must be installed on all participating WinCC Runtime Professional stations.
- Licensing  
SIMATIC Logon (basic license) is included in the basic package of WinCC Runtime Professional

#### Benefits

- Centralized configuration of all access authorizations of a distributed system avoids unnecessary travel times. Time-consuming multiple configurations for each individual local station become unnecessary. Accordingly, users can be easily configured from a central location.
- All access data apply throughout the plant on every connected station. Additional access data on local subsystems is no longer necessary.

#### Design

#### **SIMATIC Logon for Panels and WinCC Runtime Advanced**

SIMATIC Logon and SIMATIC Logon Remote Access are installed on a central station.

The following Runtime stations are connected to the central station via the Ethernet network:

- PCs with WinCC Runtime Advanced
- SIMATIC Panels from the 177 series or higher (with Ethernet interface)
- SIMATIC Mobile Panels from the 177 series or higher (with Ethernet interface)
- SIMATIC Multi Panels
- SIMATIC Comfort Panels

#### **SIMATIC Logon for WinCC Runtime Professional**

The SIMATIC Logon can be used for the central user management of several WinCC Runtime Professional stations. Operation in a Windows Workgroup or even in a domain is possible.

#### Function

Users receive a unique user ID, user name and password. This information is encrypted and stored at a central point (for SIMATIC Logon in the Windows user management). Functions such as changing the password, automatic log-off after a pre-defined time and lockout after several incorrect entries of a password ensure maximum security of operation. In addition, SIMATIC Logon allows setting up new users online, plant-wide and across applications, or blocking of existing users. SIMATIC Logon also supports electronic signature.

#### Ordering data

#### Article No.

<b>SIMATIC Logon V1.6</b> Basic license <sup>1)</sup> For Panels or WinCC Runtime Advanced stations, the corresponding number of additional SIMATIC Logon Remote Access licenses is required. No SIMATIC Logon Remote Access licenses are required for WinCC Runtime Professional	<b>6ES7658-7BX61-0YA0</b>
<b>SIMATIC Logon upgrade to V1.6</b>	<b>6ES7658-7BX61-0YE0</b>
<b>SIMATIC Logon Remote Access (3 clients)</b> Remote Access for 3 clients; single license for 3 SIMATIC Logon Remote Access clients; the number of licensed clients is determined from the sum of the installed SIMATIC Logon Remote Access licenses.	<b>6ES7658-7BA00-2YB0</b>
<b>SIMATIC Logon Remote Access (10 clients)</b> Remote Access for 10 clients; single license for 10 SIMATIC Logon Remote Access clients; the number of licensed clients is determined from the sum of the installed SIMATIC Logon Remote Access licenses.	<b>6ES7658-7BB00-2YB0</b>

<sup>1)</sup> SIMATIC Logon V1.5 included in scope of supply of WinCC Runtime Professional.

More information is available at:

<http://www.siemens.com/simatic-logon>

## Overview

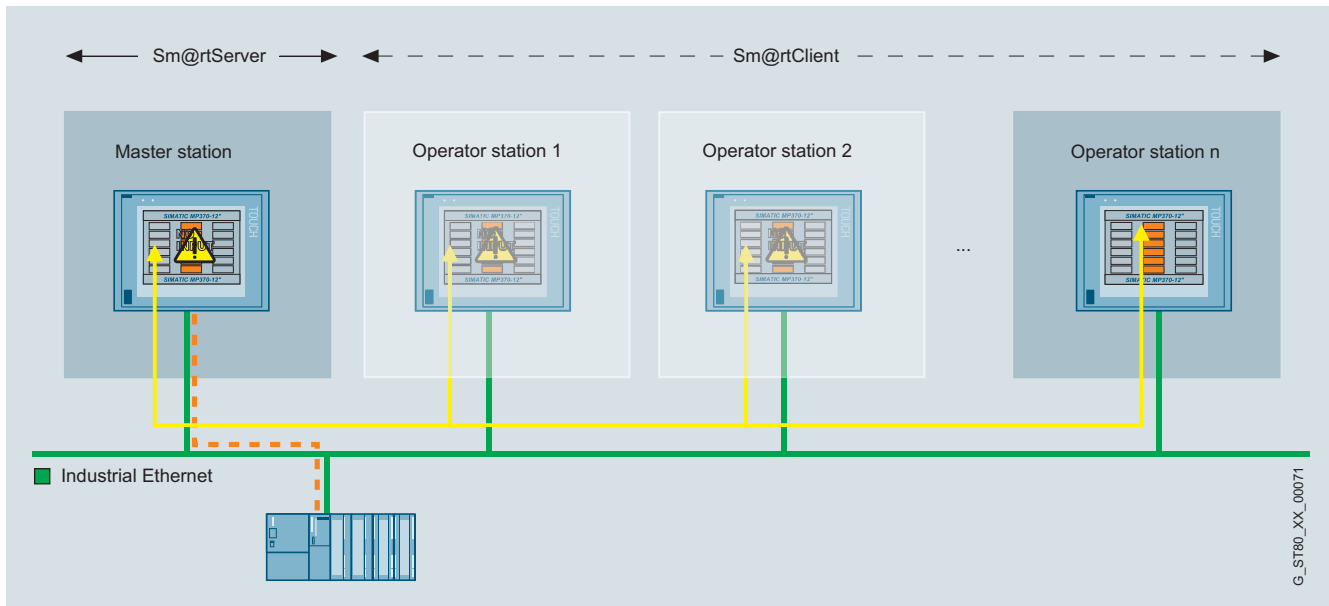

- Option for SIMATIC WinCC Runtime Advanced plus SIMATIC Panels for communication between various SIMATIC HMI systems.
- Available for the following SIMATIC HMI systems:
  - Basic Panels 2<sup>nd</sup> Generation (with Ethernet interface)
  - Comfort Panels
  - Mobile Panel 2<sup>nd</sup> Generation
  - TP 177B PN/DP, OP 177B PN/DP
  - TP 277, OP 277
  - MP 177, MP 277, MP 377
  - WinCC Runtime Advanced
- A SIMATIC HMI system can be used to control or monitor another system remotely; entry level for client/server configurations for distributed operator stations or for solutions with head end or control room
- Local operation, visualization and data processing are as possible as plant-wide access to information. Integrated information flows ensure an overview of the status of all processes.
- Licensing:
  - The "SIMATIC WinCC Sm@rtServer for Panel" or "SIMATIC WinCC Sm@rtServer for Basic Panel" or "SIMATIC WinCC Sm@rtServer for Runtime Advanced" license must be installed on the server HMI device.
  - A separate license is no longer required for Comfort / Mobile Panels Version V14 or higher and for Runtime Advanced Version V14 SP1 or higher.
  - A license is not required for the engineering system for configuring the runtime option.

### Note:

When accessing the operator stations via the Sm@rtServer option, suitable protective measures (including IT security such as network segmentation) should be taken in order to ensure safe operation of the system.

Additional information on the topic of industrial security is available on the Internet at:

<http://www.siemens.com/industrialsecurity>

## Benefits

- Flexible solution for remote access to HMI systems
- Quick elimination of malfunctions or downtimes – thus increasing the productivity – through global access to machines/plants by the service and maintenance personnel.
- Avoidance of on-site service calls.

# HMI Software

HMI Software in the TIA Portal  
SIMATIC WinCC (TIA Portal) options

## WinCC Sm@rtServer

### Application

- Operator control and monitoring of machines covering large areas with several operator stations by one operator.
- Operator control and monitoring of machine-level HMI systems from one central station (e.g. head-end station of a production line or from a control room)
- Remote maintenance and servicing of machines/plants over the Internet/Intranet

3

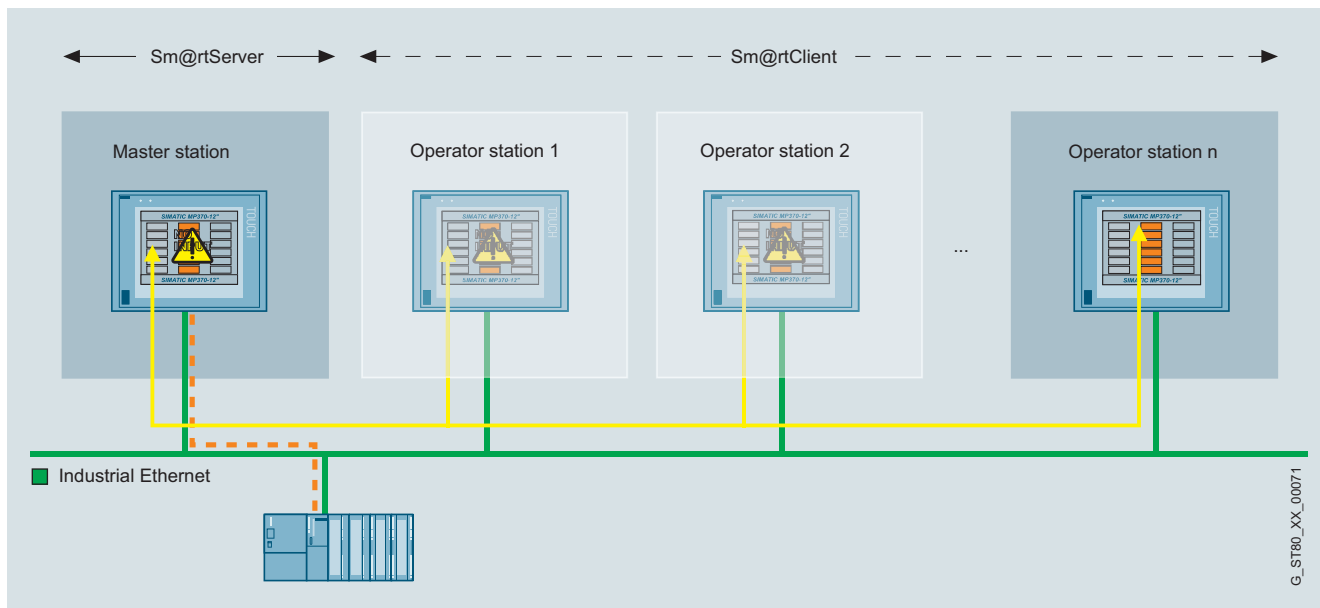

Application of the Sm@rtClient concept: Coordinated operation of several operator stations

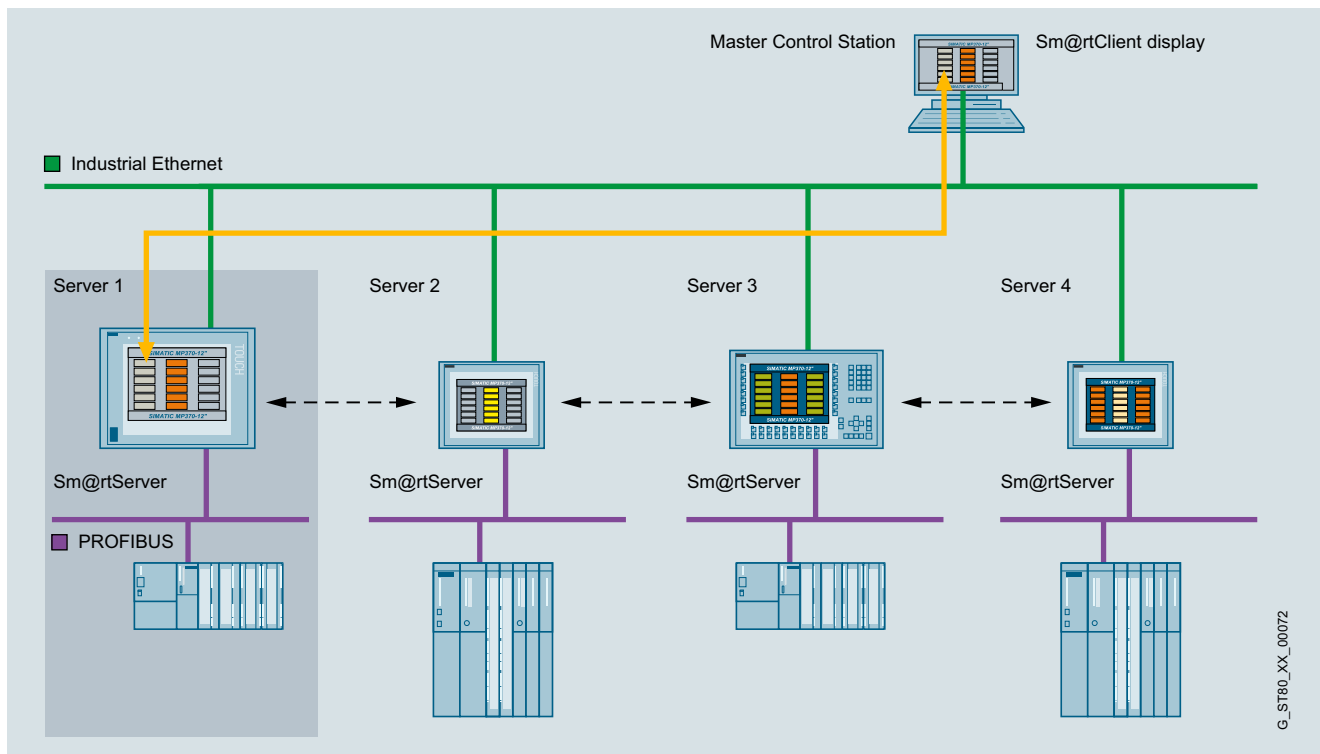

Use of the Sm@rtClient display: Operator control and monitoring of machine-level HMI systems from one central station

## Application (continued)

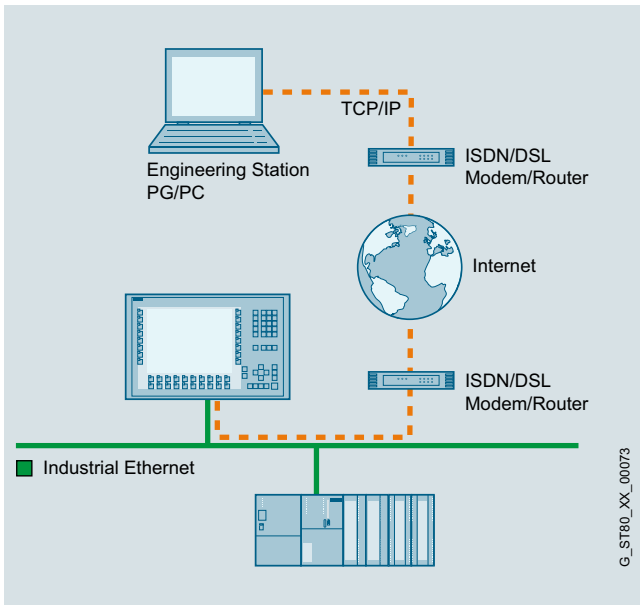

Remote operator control and monitoring of SIMATIC HMI systems using Industrial Ethernet and/or via the Intranet/Internet

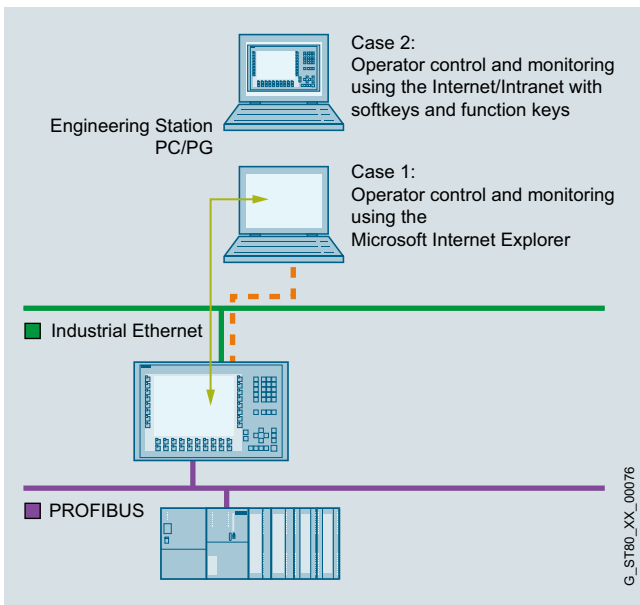

Remote operator control and monitoring of SIMATIC HMI systems using Industrial Ethernet and/or via the Intranet/Internet

## Function

### Coordinated operation of several operator stations:

- The HMI application and communication with the controller takes place via the master station. "Sm@rtClients" can be activated from here in the case of machines/plants with larger dimensions which require a larger number of operator panels. The Sm@rtClients are then provided with access to the master station and thus to the process. Access procedures guarantee that only one operator system can actively access the process at any given time.
- Embedded in process screens, a configurable screen object (Sm@rtClient display) represents the screen of the relevant HMI system (Sm@rtServer)
- Powerful standard functions permit user-friendly and flexible operation of the display

### Remote control of an operating station:

- The HMI application and communication with the controller takes place via the HMI system. Using the Sm@rtServer, the HMI systems in the machines/systems can be serviced remotely. An access process ensures that only one operator (either locally at the machine or remotely via Internet Explorer) can actively access the process at one time.
- Microsoft Internet Explorer V6.0 SP1 or higher is sufficient for accessing an HMI system.

## HMI Software

HMI Software in the TIA Portal  
SIMATIC WinCC (TIA Portal) options

### WinCC Sm@rtServer

#### Technical specifications

WinCC Sm@rtServer	
	The values specified are maximum values
<b>Execution platform</b>	
SIMATIC Basic Panels 2 <sup>nd</sup> Generation	All devices with Ethernet interfaces
SIMATIC Comfort Panels	all
SIMATIC Panels	Mobile Panel 177 PN, Mobile Panel 277, TP/OP 177B PN/DP, TP/OP 277
SIMATIC Multi Panels	MP 177, MP 277, MP 377
PC systems	SIMATIC WinCC Runtime Advanced
<b>Number of Sm@rtClients that can simultaneously connect to a Sm@rtServer</b>	
SIMATIC Basic Panels 2 <sup>nd</sup> Generation	1 client
Comfort Panel, Mobile Panel 2 <sup>nd</sup> Generation as Sm@rtServer	2 clients for 4" devices 3 clients for 7", 9", 12" and 15" devices 2 clients for 19" devices 1 client for 22" devices
Mobile Panel 177 PN, TP/OP 177B PN/DP, MP 177 as Sm@rtServer	2 clients
Mobile Panel 277, TP/OP 277, MP 277 as Sm@rtServer	3 clients for 6" devices 2 clients for 8" and 10" devices
MP 377 as Sm@rtServer	3 clients for 12" devices 2 clients for 15" devices 1 client for 19" devices
WinCC Runtime Advanced as Sm@rtServer	5 clients

#### Ordering data

#### Article No.

##### WinCC Sm@rtServer for SIMATIC Basic Panels <sup>1)</sup>

- Single license  
License key only on USB flash drive
- As download<sup>2)</sup>  
Single license, license key download only  
Email address required for delivery

6AV2107-0CR00-0BB0

6AV2107-0CR00-0BH0

##### WinCC Sm@rtServer for SIMATIC Panels <sup>1) 3)</sup>

- Single license  
License key only on USB flash drive
- As download<sup>2)</sup>  
Single license, license key download only  
Email address required for delivery

6AV2107-0CP00-0BB0

6AV2107-0CP00-0BH0

##### WinCC Sm@rtServer for Runtime Advanced <sup>1) 4)</sup>

- Single license  
License key only on USB flash drive
- As download<sup>2)</sup>  
Single license, license key download only  
Email address required for delivery

6AV2107-0CA00-0BB0

6AV2107-0CA00-0BH0

<sup>1)</sup> The license must be installed on the Sm@rtServer HMI device. A license is not required for the engineering system for configuring the runtime option.

<sup>2)</sup> Current information and availability regarding the new delivery form can be found at: <http://www.siemens.com/tia-online-software-delivery>

<sup>3)</sup> The license is no longer required for version V14 or higher

<sup>4)</sup> The license is no longer required for version V14 SP1 or higher

#### More information

More information is available at:

<http://www.siemens.com/wincc-smartserver-tia-portal>

## Overview

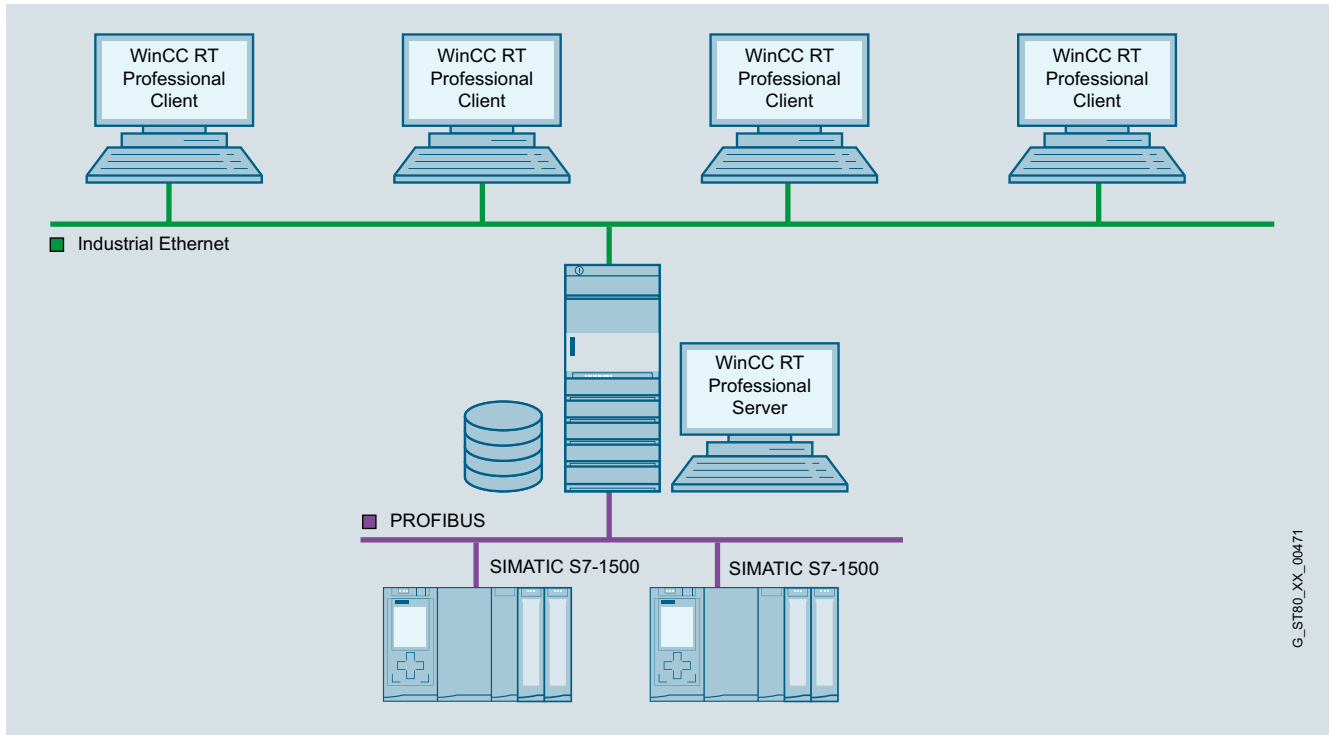

G\_STB0\_XX\_00471

WinCC TIA RT Professional - Multi-user system with operable server

- Option for SIMATIC WinCC Runtime Professional, which permits the configuration of a powerful client/server system
- One of the following operating systems must be available to install the option on the server:  
Windows Server 2003 R2 SP2, Windows Server 2008 SP2 or Windows XP Professional.  
When using Windows XP Professional, a maximum of 3 clients can be connected.
- A number of coordinated HMI stations can be operated in a single group with networked automation systems.
- Client/server solution: One server supplies up to 32 connected clients with process and archive data, alarms, screens and reports.
  - Requirement: Network connection (TCP/IP) between the server PC and the connected clients.
- Licensing:
  - A WinCC Runtime Professional license on the server with the appropriate number of PowerTags and the "WinCC Server for RT Professional" license.
  - The "WinCC Client for RT Professional" license on the clients.

## HMI Software

HMI Software in the TIA Portal  
SIMATIC WinCC (TIA Portal) options

### WinCC Server / WinCC Client

#### Benefits

- Integrated scalability from the single-user system to the client/server solution
- Considerably expanded quantity structure, relieves the load on the individual servers, and thus better performance through the distribution of the overall application or of the tasks among several servers

#### Application

In a complex plant, WinCC Runtime Professional can be configured as a distributed system depending on the requirements:

- Functional distribution (e.g. alarm server, log server, etc.), or
- Distribution corresponding to the physical plant structure (e.g. body-in-white, paint shop, etc.).

#### Function

All process data of a WinCC project is stored in different Runtime databases, e.g. alarms, trend values, etc. These Runtime databases are located on a central computer, the WinCC Server, instead on each HMI device. The operator stations, i.e. the WinCC Clients, then access the WinCC Server.

WinCC Clients and WinCC Server are independent systems.

You can also connect WinCC Clients subsequently. Alternatively, you can activate and deactivate a project from a WinCC Client.

#### Ordering data

#### Article No.

##### **SIMATIC WinCC Server for Runtime Professional**

- Single license, license key only on USB flash drive

As download<sup>1)</sup>

- Single license, license key download only, email address required for delivery

**6AV2107-0EB00-0BB0**

**6AV2107-0EB00-0BH0**

##### **SIMATIC WinCC Client for Runtime Professional V15**

- Single license, license key on USB flash drive, software and documentation on DVD

As download<sup>1)</sup>

- Single license, software and license key download, email address required for delivery

**6AV2107-0DB05-0AA0**

**6AV2107-0DB05-0AH0**

##### **SIMATIC WinCC Client for Runtime Professional ASIA V15**

Single license, license key on USB flash drive, software and documentation on DVD

**6AV2107-0DB15-0AA0**

<sup>1)</sup> Current information and availability regarding the new type of delivery can be found at: <http://www.siemens.com/tia-online-software-delivery>

A license is not required for the engineering system for configuring the runtime option.

#### More information

More information is available at:

<http://www.siemens.com/wincc-server-tia-portal>



#### Overview

Option for SIMATIC WinCC (TIA Portal), supporting the parallel operation of two interfaced WinCC single-user systems or process data servers for mutual monitoring

If one of the two server PCs or one of the two WinCC stations fails, the second one will take over control of the entire system. Once the failed server or station is restored to operation, the contents of all the message and process value archives are copied to it.

One WinCC Redundancy package is required for each redundant pair of servers.

#### Benefits

- Increased system availability with gap-free data integrity
- Automatic switchover of the client when a server fails or the communication to the server fails
- Continuous operation and visualization through automatic switchover of the clients to the intact server
- Automatic synchronization of all archives in the background after a fault is cleared

#### Function

Normally, two WinCC stations or process data servers run in parallel. Each station has its own process connection and its own data archives. WinCC Redundancy ensures automatic matching of system and user archive data.

If one of the two server computers or WinCC stations fails, the second will take over the archiving of messages and process data, thereby ensuring seamless data integrity. In client/server mode, the clients are automatically switched from the failed server to the redundant partner. This ensures continuous plant visualization and operation on every operator station.

When the failed partner resumes operation, all process values, messages and data archived during the fail period are automatically matched with the partner. This process runs in the background and does not affect plant continuity. Once this is complete, two equivalent servers/stations will be available again.

Communication with the SIMATIC S7 PLC can also be configured with redundancy (an H Series SIMATIC S7 is required) by plugging in two communication modules and configuring two communication paths (S7-REDCONNECT software package). The use of failsafe H Series SIMATIC S7 PLCs can, if required, further increase availability at control level.

#### Ordering data

##### SIMATIC WinCC Redundancy for Runtime Professional

- Single license for 2 installations, license key on USB flash drive, software and documentation on DVD
- As download<sup>1)</sup>  
Single license for 2 installations, license key download only  
Email address required for delivery

#### Article No.

6AV2107-0FB00-0BB0

6AV2107-0FB00-0BH0

<sup>1)</sup> Current information and availability regarding the new type of delivery can be found at: <http://www.siemens.com/tia-online-software-delivery>

A license is not required for the engineering system for configuring the runtime option.

#### More information

More information is available at:

<http://www.siemens.com/wincc-redundancy-tia-portal>

## HMI Software

### TIA Portal options

#### SIMATIC Visualization Architect

##### Overview

##### **SIMATIC Visualization Architect**

###### Challenge:

- To standardize the user interfaces of the visualizations throughout the plant
- Significant reduction of the engineering costs for generating the visualizations

###### Solution:

- Automatic generation and creation of the visualizations, based on the program code of the controller and corresponding visualization objects within the framework of system-wide library concepts.

##### Licensing

- The software can be installed on multiple computers. The number of existing licenses determines the number of computers on which the software can be used simultaneously (floating license).
- An upgrade to version V15.1 is offered to users of the previous version V14
- A rental license is available for temporary use
- A trial license is available for testing purposes
- It is possible to conclude Software Update Service (SUS) contracts

You can find more information on the Software Update Service, license types, online software delivery and handling your SW licenses with the Automation License Manager here:

[www.siemens.com/simatic-licenses](http://www.siemens.com/simatic-licenses)

##### Benefits

- Automatic creation of visualizations – drastic reduction of the engineering time
- Reduction of the commissioning times by the early detection and avoidance of faults
- Adaptation at the touch of a button to the visualizations on the basis of changes/adaptations in the control program

##### Function

- Integration in the TIA Portal V14 or higher
- Support of controllers:
  - S7-1200, S7-1500, ET200SP
- Support of HMI:
  - Basic Panels, Comfort Panels and Mobile Panels of the 2<sup>nd</sup> Generation
- Support of PC-based:
  - WinCC Runtime Advanced, WinCC Runtime Professional, S7-1500 Software Controller
- SiVArc is configured using rules (not programmed!)

##### Technical specifications

SIMATIC Visualization Architect	
Operating system requirements	In accordance with the requirements of the TIA Portal components: <ul style="list-style-type: none"> <li>• SIMATIC STEP 7 (TIA Portal)</li> <li>• SIMATIC WinCC Professional, Advanced, Comfort, Basic</li> </ul>
Supported STEP 7 version	SIMATIC STEP 7 V15.1
Supported WinCC versions	SIMATIC WinCC V15.1 Professional, Advanced, Comfort, Basic

##### Ordering data

##### Article No.

###### SIMATIC Visualization Architect V15.1

###### As package

- SIMATIC Visualization Architect V15.1
- SIMATIC Visualization Architect V15.1 Rental
- SIMATIC Visualization Architect V15.1 Trial; Download in Customer Support Portal

###### Download <sup>1)</sup>

- SIMATIC Visualization Architect V15.1
- SIMATIC Visualization Architect V15.1 Rental

###### Upgrade SIMATIC Visualization Architect V14 -> V15.1

Engineering software in the TIA Portal; Software and documentation on CD, License key on USB flash drive; Class A; 6 languages: en, de, fr, es, it, zh

- As package
  - Download <sup>1)</sup>
- Email address required for delivery

6AV2107-0PX05-0AA5

6AV2107-0PX05-0AA6

6AV2107-0PX05-0AA7

6AV2107-0PX05-0AH5

6AV2107-0PX05-0AH6

6AV2107-3PX05-0AA5

6AV2107-3PX05-0AH5

<sup>1)</sup> For up-to-date information and download availability, see: <http://www.siemens.com/tia-online-software-delivery>

##### More information

For up-to-date information and availability, see:

<http://www.siemens.com/sivarc>

**Overview**

The TIA Portal option ProDiag makes it possible to monitor a machine or plant and to intervene in the event of a fault. The monitoring messages which can be generated for the various faults provide specific information on the monitoring mode, location and cause of the fault. Information on troubleshooting can be provided in addition. Plant operators can then not only recognize faults, they can also identify any potential danger in advance and take appropriate countermeasures.

**Licensing**

- The runtime license for controllers includes 250 monitoring operations for multiple CPUs or an unlimited number of monitoring operations for a single CPU. From FW 2.0 onwards, the software can run on S7-1500/ET 200SP CPUs regardless of the TIA Portal version.
- For the visualization of the messages, the controls are licensed according to the HMI runtime platforms.

You can find more information on the Software Update Service, license types, online software delivery and handling your SW licenses with the Automation License Manager here:

[www.siemens.com/simatic-licenses](http://www.siemens.com/simatic-licenses)

**Benefits**

- Automatic code generation in the CPU
- Message texts are derived automatically from the information existing in the project
- Simple visualization on the HMI by means of prepared controls

**Application**

SIMATIC ProDiag is the fully-integrated TIA solution for machine and plant diagnostics. It saves the need for programming diagnostics in the CPU during the engineering phase and provides support for troubleshooting on the HMI.

**Function**

- Central, cycle-exact time stamping of the fault messages
- Automatic generation of the monitoring logic and message calls
- Automatic updating of the SIMATIC HMI when changing the message configuration for 3 languages
- HMI systems do not have to exit runtime mode in the event of changes
- Directly available in the language editors LAD, FBD, SCL and STL
- Monitoring can be parameterized at a later date on F blocks and know-how-protected blocks
- Central definition of message structure for the project

**Technical specifications****Can be used for**

SIMATIC ProDiag S7-1500

For all S7-1500 CPUs and ET 200SP CPUs with FW V2.0 and higher

**Ordering data****Article No.****SIMATIC ProDiag S7-1500 for 250 monitoring functions**

For SIMATIC S7-1500 CPUs and ET 200SP CPUs with FW 2.0 and higher. Independent of the TIA Portal version.

- Package with data storage medium **6ES7823-0AA00-1AA0**
- Download incl. license key <sup>1)</sup>  
Email address required for delivery **6ES7823-0AE00-1AA0**

**SIMATIC ProDiag for SIMATIC Comfort / Mobile Panels**

Controls for SIMATIC WinCC as of V14.

- Package with data storage medium **6AV2107-0UP00-0BB0**
- Download incl. license key <sup>1)</sup>  
Email address required for delivery **6AV2107-0UP00-0BH0**

**SIMATIC ProDiag for WinCC Runtime Advanced**

Controls for SIMATIC WinCC as of V14.

- Package with data storage medium **6AV2107-0UA00-0BB0**
- Download incl. license key <sup>1)</sup>  
Email address required for delivery **6AV2107-0UA00-0BH0**

**SIMATIC ProDiag for WinCC Runtime Professional**

Controls for SIMATIC WinCC as of V14

- Package with data storage medium **6AV2107-0UB00-0BB0**
- Download incl. license key <sup>1)</sup>  
Email address required for delivery **6AV2107-0UB00-0BH0**

<sup>1)</sup> For up-to-date information and download availability, see: <http://www.siemens.com/tia-online-software-delivery>

**More information****TIA Portal highlights**

<http://www.siemens.com/tiaportal>

**Software download**

For up-to-date information and download availability, see:

<http://www.siemens.com/tia-online-software-delivery>

## HMI Software

Software for energy management

### Software for energy management

#### Overview

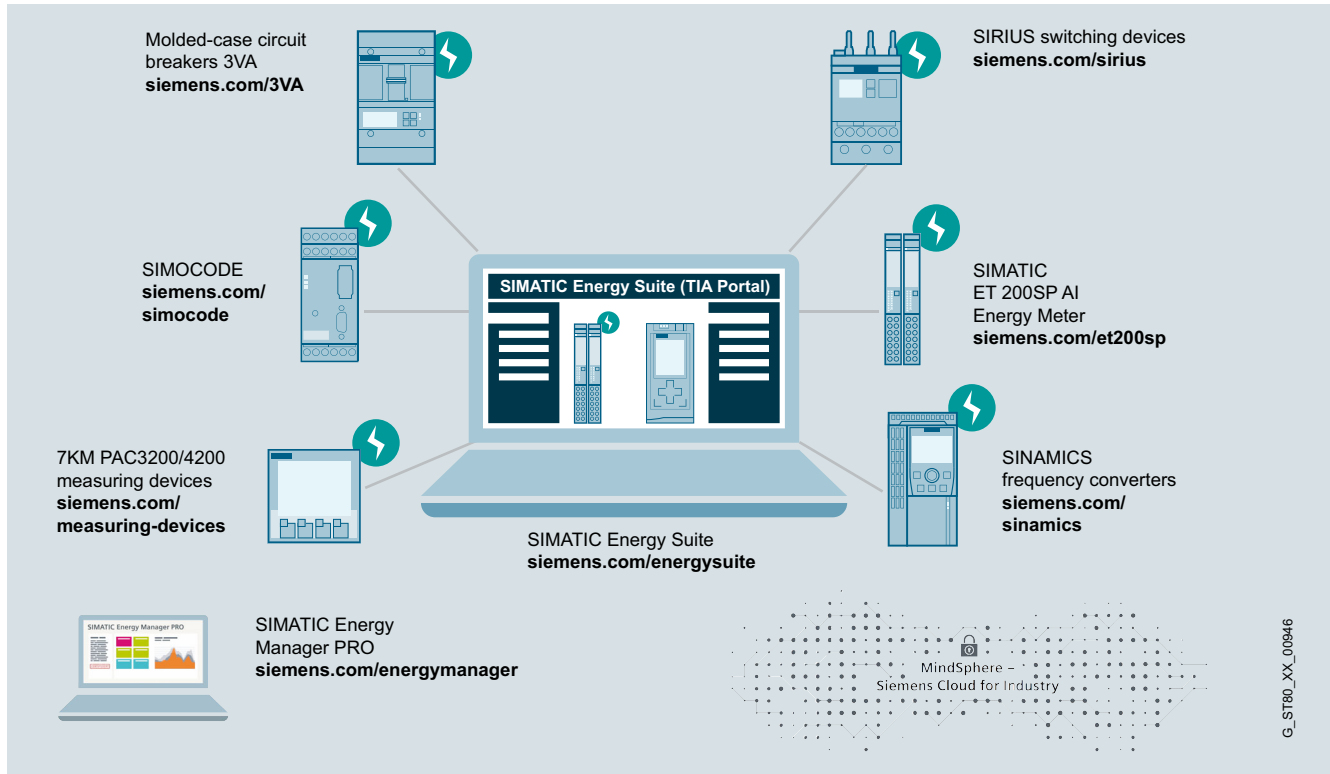

Energy management, system overview

SIMATIC offers numerous reasons for corporate energy management in industrial plants. However, there is one in particular: It makes an important contribution towards improving plant productivity.

This results in enhanced competitiveness. Energy management with SIMATIC makes energy flows transparent in production plants. This supports the analysis and derivation of energy saving potential. The result: Permanently increased efficiency, higher productivity and an improved cost situation.

<http://www.siemens.com/simatic-energy-management>

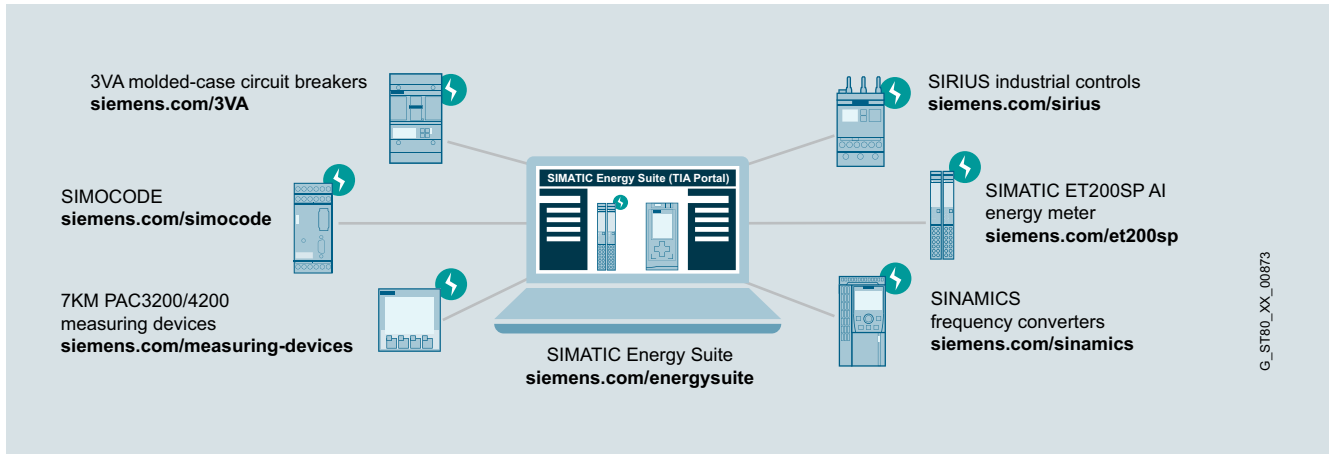
**Overview**

**SIMATIC Energy Suite**

A high energy consumption and automated production are typical for many industries. If you want to keep your energy costs under control in the long term and you are already focusing on the digital future, you will equip your plant with integrated energy measuring technology, thus anchoring your energy management in the automation of your production processes – which is where most energy is consumed.

SIMATIC Energy Suite as an integrated option for the TIA Portal efficiently links energy management with automation, thus creating energy transparency in the production system.

The considerably simplified configuration of energy measuring components from the SIMATIC, SENTRON, SINAMICS, SIRIUS und SIMOCODE product families significantly reduces configuration costs.

Due to the integrated interface to SIMATIC Energy Manager, the recorded energy data can be seamlessly expanded into a cross-site energy management system.

Companies can therefore additionally satisfy all required economic and energy management aspects – from the purchasing of energy and planning, right up to energy controlling.

**Functional enhancement for energy efficiency evaluation of machines:**

Especially for evaluation of the product-related energy efficiency of machines, the S7 instruction "Energy efficiency monitor for machines" extends the scope of the SIMATIC Energy Suite functions.

As part of the instruction library of STEP 7 (TIA Portal), the function can be integrated in the machine control system by the machine manufacturer.

By linking the energy consumption, the production counter and the operating state, easy evaluation of the energy efficiency is possible based on energy performance indicators (EnPI).

## HMI Software

### Software for energy management

#### SIMATIC Energy Suite

##### Benefits

###### Highlights:

- Integrated into the TIA Portal and automation
- Simple and intuitive configuration instead of complex manual programming
- Automatic generation of the PLC energy program for S7-1500 controllers
- User-friendly integration of measuring components from the Siemens portfolio and from other vendors
- Archiving in the tags archive of WinCC Professional or on the PLC-internal SIMATIC Memory Card
- Seamless connection to SIMATIC Energy Manager
- Production-related and standardized determination of energy consumption in machines (in accordance with VDMA 34179)
- Easy integration into machine control system (S7-1500 / S7-1200) and on-site visualization of the efficiency status and the energy performance indicators (EnPI)
- Automatic long-term measurements (e.g. batch, layer)
- Creation of an efficiency log (.csv) for detailed evaluation and documentation

##### Design

SIMATIC Energy Suite consists of the following components:

###### Engineering components (TIA Portal):

- Adds new, integrated editors for configuration of the energy measurement points to the TIA Portal
- Includes S7 program generator for the automatic generation of the complete S7 program
  - For acquisition, processing, buffering and archiving (WinCC Professional or SIMATIC Memory Card) of the basic energy values relevant to billing (power rating and energy)
  - Also for the extended energy values (including voltage, current, frequency) for measuring devices that offer this function and are supported within the scope of the Energy Support Library (see below).

###### WinCC Runtime components (toolbox for WinCC Professional):

- Export tool for exporting the energy data archived periodically in WinCC Professional in Excel files
- Transfer tool for buffered communication of the periodic energy values relevant to billing from S7-1500 CPUs to the tag archive of WinCC Professional

###### S7 driver block library (Energy Support Library - EnSL):

- Contains S7 blocks for simplified communication with measuring components from the product families SIMATIC, SENTRON, SINAMICS, SIRIUS and SIMOCODE. Installation of the Energy Support Library (EnSL) enables the supported devices to be recognized by the Energy Suite. They can then be configured as energy data sources simply by selecting the devices – making complex communication programming unnecessary. Details on the currently supported devices can be found here: <http://www.siemens.com/energysuite-hardware>

##### Function

###### Simple configuration direct in the TIA Portal

The SIMATIC Energy Suite is an option package for STEP 7 and WinCC (TIA Portal) which integrates new editors into the engineering HMI of the TIA Portal. These editors can be used to create and configure energy measuring points (so-called 'energy objects') in a simple manner. In addition to various parameters which are available, the following steps are of central importance when configuring an energy object:

- Assignment of an energy data source
  - The data source can be any tag from the data function of the PLC (power rating value, energy count value or pulse signal from e.g. tag table, data block etc.) or from one of the devices supported by the Energy Support Library (see "Design" Topic).
- Assignment of a calculation and archiving period
  - Each energy object can be assigned an individual calculation and archiving period (1 min up to 24 h) for preprocessing the power rating and energy values relevant to billing. For example, energy suppliers bill electrical energy in 15-min periods and piped media (e.g. water) in 60-min periods.

###### Automatic program generation instead of complex programming

Following the completed configuration of all energy objects, the S7 energy program is automatically generated by the program generator of the Energy Suite. This energy program can be downloaded to the controller (S7-1500) immediately after the compilation, and commences at once with recording and preprocessing of the energy values.

###### Energy data recording and preprocessing is already carried out in the automation environment, close to the consumers

The recorded energy data is standardized and calculated according to the set archiving period, provided with a time stamp, and is ready for archiving. Archiving of the power rating and energy values relevant to billing can be made directly on the PLC-internal SIMATIC Memory Card or in a connected WinCC Professional archive.

###### Free choice of archive location

Archiving of the power rating and energy values relevant to billing can be made directly on the PLC-internal SIMATIC Memory Card or in a connected WinCC Professional archive.

- Archiving on SIMATIC Memory Card
  - The energy data is directly saved on the CPU-internal SIMATIC Memory Card according to the respective archiving period. The data is always available there as a CSV file for direct downloading via the CPU's web server
- Archiving in the WinCC Professional archive
  - The basic energy data (power rating and energy values) relevant to billing is saved in the archive of a connected WinCC Professional system according to the respective archiving period.

**Function** (continued)

Buffered communication:

To ensure high data quality, the basic energy data (power rating and energy values) is buffered in the WinCC archive prior to transfer. This data relevant to billing is then still available in the WinCC archive without losses or errors, even after a longer interruption in communication with the archive system (e.g. when restarting the PC or when there is a fault in the IT infrastructure).

Export tool for simple reading of energy data

The power rating and energy data (basic energy values relevant to billing) in the archive of the WinCC Professional system can be directly exported from the archive database to an Excel file using the supplied export tool. It is possible to create individual export templates with free selection of measuring points and time periods. These templates can subsequently be started fully automatically, or manually at a time selected by the user (e.g. at the beginning of each month).

Display and monitoring of the energy data

When generating the energy program, the power rating and energy data (basic energy values relevant to billing) of the individual measuring points (energy objects) are made available in uniform S7 blocks with standardized data structures. These data include all the relevant configuration data in addition to the current and periodic energy values. Thanks to this central and homogenized provision of data in the S7 CPU, it is very easy to implement additional real-time monitoring and evaluation (e.g. calculation of key statistics) in the control program, as well as uniform visualization of the energy data and energy parameters on HMI and SCADA screens.

**Technical specifications**

<b>SIMATIC Energy Suite V15</b>	
<b>PC hardware requirements</b>	<ul style="list-style-type: none"> <li>In accordance with the requirement of the TIA Portal components:               <ul style="list-style-type: none"> <li>- SIMATIC STEP 7 (TIA Portal)</li> <li>- SIMATIC WinCC Professional, Advanced, Comfort, Basic</li> </ul> </li> </ul>
<b>Operating system requirements</b>	<ul style="list-style-type: none"> <li>In accordance with the requirement of the TIA Portal components:               <ul style="list-style-type: none"> <li>- SIMATIC STEP 7 (TIA Portal)</li> <li>- SIMATIC WinCC Professional, Advanced, Comfort, Basic</li> </ul> </li> </ul>
<b>Supported STEP 7 version</b>	<ul style="list-style-type: none"> <li>SIMATIC STEP 7 V15</li> </ul>
<b>Supported WinCC versions</b>	<ul style="list-style-type: none"> <li>SIMATIC WinCC V15 Professional, Advanced, Comfort, Basic</li> </ul>
<b>Supported SIMATIC CPUs</b>	<ul style="list-style-type: none"> <li>SIMATIC Energy Suite</li> <li>S7 Energy Efficiency Monitor for Machines</li> </ul>
	<ul style="list-style-type: none"> <li>Runs on all S7-1500 CPUs (except S7-1500S) and ET 200SP CPU; with FW V2.0 and higher.</li> <li>Runs on all S7-1500 CPUs and ET 200SP CPUs; with FW V2.1</li> <li>Runs on all S7-1200 CPUs; with FW V4.2</li> </ul>

## HMI Software

Software for energy management

### SIMATIC Energy Suite

#### Ordering data

#### Article No.

#### Article No.

##### Engineering package

Includes installation medium, floating license for engineering as well as license certificates<sup>3)</sup> for 10 energy objects<sup>1)</sup> (2x5 EnO).

##### SIMATIC Energy Suite V15.1 Engineering

including 10 energy objects<sup>1)</sup> (2x5 EnO)

- As package
- [Download](#)<sup>4)</sup>

6AV2108-0AA05-0AA5  
6AV2108-0AA05-0AH5

##### SIMATIC Energy Suite upgrade V14 to V15.1

- As package
- [Download](#)<sup>4)</sup>

6AV2108-3AA05-0AE5  
6AV2108-3AA05-0AK5

##### Trial package

##### SIMATIC Energy Suite V15.1 Engineering Trial (21 days)

As package

6AV2108-0AA05-0AA7

##### PLC runtime licenses<sup>2)</sup>

Includes license certificates<sup>3)</sup> for activating additional energy objects<sup>1)</sup> (EnO).

##### SIMATIC Energy Suite Engineering Software Update Service<sup>5)</sup>

- Data storage medium package
- [Download](#)<sup>4)</sup>  
Email address required for delivery

6AV2108-0AA00-0AL0  
6AV2108-0AA00-0AY0

##### SIMATIC Energy Suite S7-1500

SIMATIC Energy Suite S7-1500, 5 energy objects<sup>1)</sup> (1 x 5 EnO)

- As package
- [Download](#)<sup>4)</sup>

6AV2108-0CF00-0BB0  
6AV2108-0CF00-0BH0

SIMATIC Energy Suite S7-1500, 10 energy objects<sup>1)</sup> (1 x 10 EnO)

- As package
- [Download](#)<sup>4)</sup>

6AV2108-0CH00-0BB0  
6AV2108-0CH00-0BH0

SIMATIC Energy Suite S7-1500, 10 energy objects<sup>1)</sup> (2 x 5 EnO)

- As package
- [Download](#)<sup>4)</sup>

6AV2108-0DF00-0BB0  
6AV2108-0DF00-0BH0

SIMATIC Energy Suite S7-1500, 50 energy objects<sup>1)</sup> (5 x 10 EnO)

- As package
- [Download](#)<sup>4)</sup>

6AV2108-0FH00-0BB0  
6AV2108-0FH00-0BH0

SIMATIC Energy Suite S7-1500, 100 energy objects<sup>1)</sup> (10 x 10 EnO)

- As package
- [Download](#)<sup>4)</sup>

6AV2108-0HH00-0BB0  
6AV2108-0HH00-0BH0

##### S7 Energy Efficiency Monitor for Machines

Includes license certificate<sup>5)</sup> for activating the S7 instruction for energy efficiency evaluation especially for machines

##### S7 Energy Efficiency Monitor for Machines S7-1500 / S7-1200

- As package
- [Download](#)<sup>4)</sup>

6AV2108-1CF00-0BB0  
6AV2108-1CF00-0BH0

<sup>1)</sup> Energy object (EnO) corresponds to 1 energy process tag (e.g. one measuring instrument, one energy counter, one pulse signal)

<sup>2)</sup> PLC runtime licenses are countable and version-neutral

<sup>3)</sup> The correct number of existing license certificates must be configured in the properties of the CPU hardware in the TIA Portal.

<sup>4)</sup> For up-to-date information and download availability: <http://www.siemens.com/tia-online-software-delivery>

<sup>5)</sup> The license number on the certificate is used to activate the S7 instruction; a license certificate is required for each machine.

Additional information is available on the Internet at:

SIMATIC Energy Suite:

<http://www.siemens.com/simatic-energy-suite>

Energy Support Library (EnSL):

<http://www.siemens.com/energysuite-hardware>

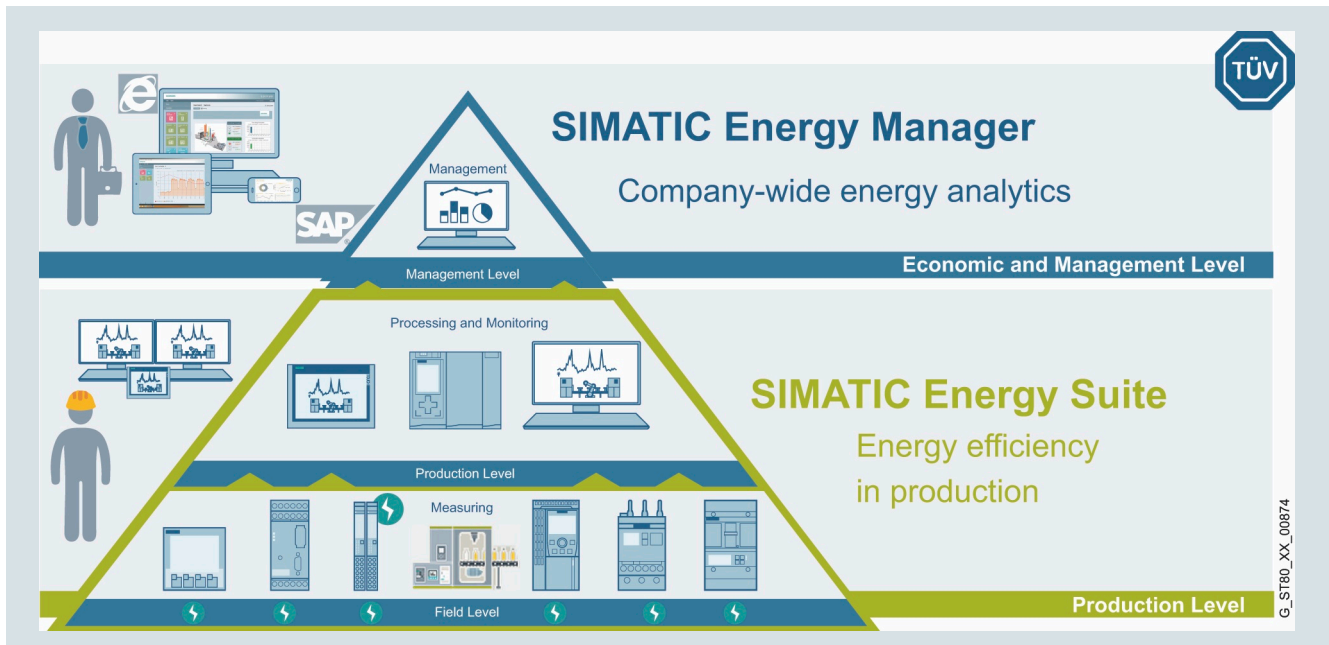

**Overview**

**SIMATIC Energy Manager V7.1**

SIMATIC Energy Manager V7.1 makes energy flows and costs transparent—in both infrastructure and production.

SIMATIC Energy Manager provides users with a scalable, non-sector-specific energy data management system for industrial operations.

Its functions range from energy monitoring, energy controlling, energy invoicing, baseline management and prognosis, through to the management of energy efficiency measures.

Among other things, SIMATIC Energy Manager provides an extensive and easy-to-use report system, as well as a dynamic, widget-based web dashboard for analyzing and distributing data once it has been acquired and analyzed.

*SIMATIC Energy Manager* is available in a **Basic** and a **PRO version**.

**Advantages:**

- Appropriate energy efficiency measures can be devised based on performance indicators and display options. When implemented successfully, cost savings are achieved
- Transparency at cost center level raises employee awareness and forms the basis for specifying clear, easy-to-understand aims, as well as for monitoring their achievement
- Close proximity to production allows energy performance evaluation of technological processes and equipment (e.g.: analysis based on machine status)
- Transparency combined with prognosis functions increases planning reliability and opens up new opportunities in energy procurement
- Energy controlling, with its flexible reporting and analysis functions, helps to ensure that efficient systems remains efficient
- Generates metrics for well-founded suggestions for increasing the efficiency of power generation systems and loads
- Fulfills legal obligations for monitoring and reporting on greenhouse gas emissions (CO<sub>2</sub>)

**Note:**

Upgrading from SIMATIC Energy Manager PRO 7.0 to SIMATIC Energy Manager PRO 7.1 is possible at any time and is included in the SIMATIC Energy Manager PRO SUS.

## HMI Software

### Software for energy management

#### SIMATIC Energy Manager

##### Benefits

###### Highlights of version 7.1

###### Simple entry with the SIMATIC Energy Manager Basic:

Energy Manager Basic can be configured completely in the web and provides you with a simple introduction to energy data management. An upgrade from the Basic variant to the PRO variant is possible at any time with the appropriate license key.

- Web-based system
- Easy configuration of dashboards, charts and reports
- Configuration of data points and the OPC UA, OPC DA, OPC HDA, Energy Suite, WinCC/PCS 7, and Modbus/TCP interfaces, as well as manual data acquisition
- Simple authorization concept
- The web client is available in the languages en, de, it, fr, es and cn
- Configuration of key data with a formula editor
- Configuration of parameters to display prices or factors
- Tabular overview and options for structuring data sources, data points, key data and parameters
- Configuration of essential settings, e.g. email settings, backup, units, regional settings, account settings

###### Data export into MindSphere V3.0 also possible with Energy Manager Basic:

- Data points can be created automatically in MindSphere
- Data can be transferred cyclically into MindSphere

###### Support of the S7 energy efficiency monitor by Energy Manager PRO:

- The S7 energy efficiency monitor as an instruction in the TIA Portal allows machine status-related energy data acquisition. Data is transferred to Energy Manager PRO via a communication module.
- Uniform and comparable display of efficiency indicators of machines/lines/cost centers
- Display of energy consumption and costs at machine level and cost center level
- Energy consumption and costs per workpiece, or shift
- Benchmarking of same machines/workpieces from different manufacturers

###### Setup:

- The setup can be used for updating Energy Manager PRO 7.0 as well as for a direct upgrade from B.Data 6.0 to Energy Manager PRO V7.1. The licenses have to be upgraded in the usual way, with a license update from 6.0 to 7.0, and then from 7.0 to 7.1.
- Upgrading from Energy Manager Basic to Energy Manager PRO is possible at any time with an appropriate license key

##### Design

###### **SIMATIC Energy Manager V7.1**

SIMATIC Energy Manager is available in a Basic and a PRO version. Basic is the starter version and is entirely web-based. An upgrade from Basic to PRO is possible by means of a license key. Both versions are supplied in a basic package to which tag packages can be added.

The **SIMATIC Energy Manager Basic** package includes:

- 50 tags
- 1 Energy Manager PRO acquisition component
- 1 Energy Manager Basic/PRO web client

The **SIMATIC Energy Manager PRO** package includes:

- 50 tags
- 1 Energy Manager PRO acquisition component
- 1 Energy Manager PRO client
- 1 Energy Manager Basic/PRO web client

Available tag packages:

- 50 tags
- 100 tags
- 250 tags
- 500 tags
- 1 000 tags
- 5 000 tags
- 30 000 tags

###### **SIMATIC Energy Manager Basic/PRO Software Update Service (SUS)**

For each Energy Manager system there is a corresponding SUS (Software Update Service), which is dependent on the number of tags.

The SUS is valid for 1 year. The contract is automatically extended by 1 more year unless canceled 3 months prior to expiration.

###### **SIMATIC Energy Manager Basic/PRO extensions**

The scope of Energy Manager can be extended with add-on packages:

- Energy Manager Basic/PRO web clients (3, 20 or 60)
- Energy Manager PRO client
- Energy Manager PRO acquisition component
- Energy Manager PRO Planning and Forecast
- Consumer Package 1 with S7-EE monitor
- Consumer Package 5 with S7-EE monitor
- Consumer Package 25 with S7-EE monitor
- Consumer Package 1 without S7-EE monitor
- Consumer Package 5 without S7-EE monitor
- Consumer Package 25 without S7-EE monitor

The number of clients and web clients indicates the number of times simultaneous access is possible.

## Function

### Acquisition and pre-processing of energy and operating data

- In addition to an interface to the SIMATIC Energy Suite, SIMATIC Energy Manager also offers the latest interface standards such as WinCC, OPC UA, OPC DA (DA, HA), OPC HDA, MODBUS TCP, ODBC, ASCII and XML, and machine drivers to the S7-EE monitor
- Preprocessing of energy data in a real-time calculation core that can be freely modeled including a formula editor for defining and configuring new calculation functions (heat calculations for boilers, quality for cogeneration plants, etc.)
- Energy Manager app for iOS and Android for mobile counter data acquisition
- Automatic plausibility check and generation of substitute values
- Long-term archive with versioning and compression functions
- Matrix editor and measured value editor for entering and processing energy and operating values
- Chart for presenting up-to-date (online) and historical load curves, as well as setpoint/actual value analyses
- Management and analysis of energy data
- Energy management dashboards for creating cross-company transparency through visualization of performance indicators and display of Sankey diagrams.



## Monitoring

An important component of energy data management is the display and evaluation of operating data and performance indicators for the purpose of identifying actions for optimization and lowering costs and consumption.

Energy Manager provides the appropriate tools for displaying and evaluating operating data and performance indicators:

- Display of current and projected operating values together in one chart
- Reporting on quantities produced, consumption and costs
- Display of all relevant company data on a single dashboard



## Controlling

Effective energy controlling is based on information about when and where energy is required. This is the only way that detailed information about optimization and potential savings can be provided. Reliable performance indicators form the basis for reports, such as those required for implementation of ISO 50001 requirements.

Energy Manager is the tool for effective controlling tasks:

- Freely configurable accounting of the energy flows of different media such as electricity, gas, or steam, from the main supply down to sub-distribution systems
- Determination of performance indicator values with direct reference to production batches or quantities for energy-related evaluation of production equipment
- Evaluation of energy purchase invoices for various media by entering counter readings, power and calculation parameters
- Target-performance analysis of energy consumption and costs according to predefined reference profiles or parameters
- Determination and display of statistical parameters such as time lines, distribution of hours or daily temperature figures
- Benchmarking of various plants or sites
- Machine-status-related energy analyses

## HMI Software

### Software for energy management

#### SIMATIC Energy Manager

##### Function (continued)

Energy Manager's automatic reporting system is used for presentations: Information is displayed in Microsoft Excel or Microsoft Word and can be prepared there as a table or diagram overview. In this way, you can generate, for example, monthly reports with current figures in Microsoft Excel, Microsoft Word or PDF format without additional configuration effort.

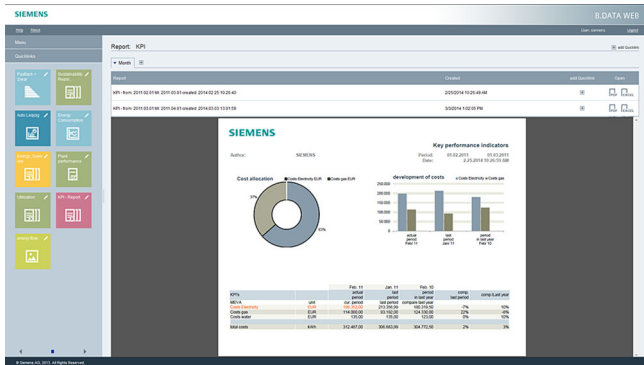

##### Cost-center-oriented accounting

Clear allocation creates awareness for saving energy and regulates accountability. Only those who are charged directly with the costs that they cause will be willing to change their behavior. By assigning costs according to the "costs-by-cause principle" and through incentive systems, cost center managers can accelerate energy-saving measures. Energy Manager enables costs-by-cause accounting of energy and material flows as well as allocation to individual plants, customers or cost units.

- Flexible modeling of hierarchic accounting structures
- Tariff allocation of quantities, flexible price assessment with tariff and price time series
- Transfer of consumption figures/costs to the ERP system

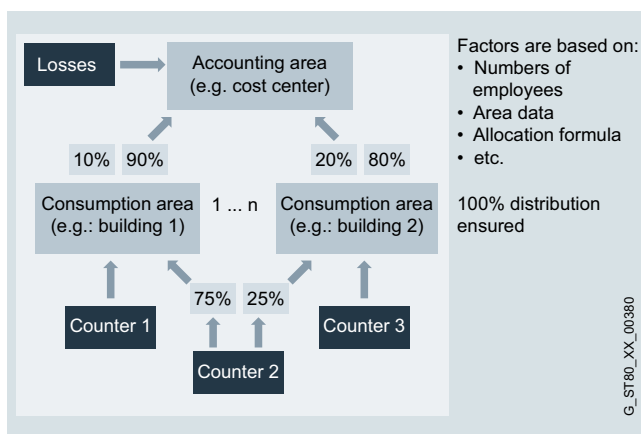

##### Baseline management

The ability to calculate performance indicators is a core task of an energy data management system. However, even if performance indicators are available, the user often still has to interpret them. With baseline management, a model based on historical data can calculate a theoretical energy consumption (baseline) for any time.

This theoretical energy consumption serves as a default value for energy monitoring or energy controlling. This enables the user to see at any time whether the actual energy consumption is above or below the calculated theoretical level. If the cumulative deviation of these two values over time is calculated, it is possible to determine the efficiency of a plant.

##### Energy forecast

Energy Manager PRO places all relevant information at your fingertips to give you the most accurate forecast possible of energy demand and of the load curve for one or more sites, buildings, production areas or individual consumers.

- Generation of requirement forecasts based on production-dependent factors (production planning) and basic load profiles (typical days)
- With multi-variable regression analysis, it is simple to evaluate and model influencing factors. This model can be used to calculate the future energy demand

##### Management of energy efficiency measures

- All of a site's energy efficiency measures are recorded centrally in Energy Manager PRO. Each energy efficiency measure can be assigned to a certain region, department or even a specific plant
- Automatic calculation of efficiency based on potential savings and costs of each energy efficiency measure
- Predefined status for implementation progress of energy efficiency measures
- Categorization: Predefined priorities or categories help to prioritize energy efficiency measures

##### Energy reporting

- Freely parameterizable report generator for creating balances, protocols, bills
- Fully automated reporting, email dispatch and document management
- Energy Manager web client for company-wide viewing of dashboards, reports and results
- Information about discrepancies from specified parameters through KPI warning system

### Technical specifications

SIMATIC Energy Manager PRO V7.1	
<b>Operating system</b>	<ul style="list-style-type: none"> <li>Windows Server 2008 R2 (English/German)</li> <li>Windows Server 2012 R2 (English/German)</li> <li>Windows Server 2016 (English/German)</li> <li>Windows 7 Professional/Ultimate SP1 (English/German)</li> <li>Windows 8.1 Pro/Enterprise 64-bit (English/German)</li> <li>Windows 10 Pro/Enterprise 64-bit (English/German)</li> <li>Minimum of 8 GB RAM</li> </ul>

SIMATIC Energy Manager PRO V7.1	
<b>Interface</b>	In addition to an interface to WinCC and S7 controllers, Energy Manager PRO also offers the latest interface standards such as OPC DA, OPC HDA, OPC UA, MODBUS TCP, ODBC, ASCII and XML.
<b>WinCC versions <sup>1)</sup></b>	<ul style="list-style-type: none"> <li>SIMATIC WinCC V7.2, V7.3 SE, V7.4</li> <li>SIMATIC WinCC RT Professional V13, V14, V15</li> </ul>
<b>PCS 7 versions <sup>2)</sup></b>	<ul style="list-style-type: none"> <li>SIMATIC PCS 7 V8.1</li> <li>SIMATIC PCS 7 V8.2</li> <li>SIMATIC PCS 7 V9</li> </ul>
<b>Virtualization</b>	<ul style="list-style-type: none"> <li>VMWare Workstation 12, 12.5, 14</li> <li>VMWare ESX 6.0, 6.5</li> <li>Microsoft Hyper-V for Windows Server 2012 R2, 2016</li> <li>Microsoft Hyper-V Server 2012 R2, 2016</li> </ul>

<sup>1)</sup> If an acquisition component is installed on a WinCC system, these requirements must also be complied with

<sup>2)</sup> The SIMATIC Energy Manager PRO system for connection to the PCS 7 must always be installed on a separate PC

### Ordering data

#### SIMATIC Energy Manager V7.1

##### Standard scope of supply

- SIMATIC Energy Manager Basic incl. 50 tags <sup>1)</sup>
- SIMATIC Energy Manager PRO incl. 50 tags <sup>1)</sup>
- SIMATIC Energy Manager PRO Powerpack Basic -> PRO
- Tag Package 50 <sup>1)</sup>
- Tag Package 100 <sup>1)</sup>
- Tag Package 250 <sup>1)</sup>
- Tag Package 500 <sup>1)</sup>
- Tag Package 1 000 <sup>1)</sup>
- Tag Package 5 000 <sup>1)</sup>
- Tag Package 30 000 <sup>1)</sup>

##### Download

- SIMATIC Energy Manager Basic incl. 50 tags <sup>1)</sup>
- SIMATIC Energy Manager PRO incl. 50 tags <sup>1)</sup>
- SIMATIC Energy Manager PRO Powerpack Basic -> PRO
- Tag Package 50 <sup>1)</sup>
- Tag Package 100 <sup>1)</sup>
- Tag Package 250 <sup>1)</sup>
- Tag Package 500 <sup>1)</sup>
- Tag Package 1 000 <sup>1)</sup>
- Tag Package 5 000 <sup>1)</sup>
- Tag Package 30 000 <sup>1)</sup>

### Article No.

6AV6372-1DF07-1AX0  
 6AV6372-2DF07-1AX0  
 6AV6372-2DF07-1AX3  
 6AV6372-2DF07-0CX0  
 6AV6372-2DF07-0DX0  
 6AV6372-2DF07-0EX0  
 6AV6372-2DF07-0FX0  
 6AV6372-2DF07-0GX0  
 6AV6372-2DF07-0HX0  
 6AV6372-2DF07-0JX0  
 6AV6372-1DF07-1AH0  
 6AV6372-2DF07-1AH0  
 6AV6372-2DF07-1AH3  
 6AV6372-2DF07-0CH0  
 6AV6372-2DF07-0DH0  
 6AV6372-2DF07-0EH0  
 6AV6372-2DF07-0FH0  
 6AV6372-2DF07-0GH0  
 6AV6372-2DF07-0HH0  
 6AV6372-2DF07-0JH0

### Article No.

#### SIMATIC Energy Manager extensions

##### Standard scope of supply

- SIMATIC Energy Manager Basic/PRO, 3 web clients
- SIMATIC Energy Manager Basic/PRO, 20 web clients
- SIMATIC Energy Manager Basic/PRO, 60 web clients
- SIMATIC Energy Manager PRO client
- SIMATIC Energy Manager PRO Planning and Forecast
- SIMATIC Energy Manager PRO acquisition component

##### Download

- SIMATIC Energy Manager Basic/PRO, 3 web clients
- SIMATIC Energy Manager Basic/PRO, 20 web clients
- SIMATIC Energy Manager Basic/PRO, 60 web clients
- SIMATIC Energy Manager PRO client
- SIMATIC Energy Manager PRO Planning and Forecast
- SIMATIC Energy Manager PRO acquisition component

6AV6372-2DF27-0AX0  
 6AV6372-2DF27-0BX0  
 6AV6372-2DF27-0CX0  
 6AV6372-2DF37-0AX0  
 6AV6372-2DF47-0AX0  
 6AV6372-2DF57-0AX0  
 6AV6372-2DF27-0AH0  
 6AV6372-2DF27-0BH0  
 6AV6372-2DF27-0CH0  
 6AV6372-2DF37-0AH0  
 6AV6372-2DF47-0AH0  
 6AV6372-2DF57-0AH0

## HMI Software

Software for energy management

### SIMATIC Energy Manager

#### Ordering data

##### SIMATIC Energy Manager PRO Consumer Package

Standard scope of supply

- Consumer Package 1 with S7-EE monitor<sup>3)</sup>
- Consumer Package 5 with S7-EE monitor<sup>3)</sup>
- Consumer Package 25 with S7-EE monitor<sup>3)</sup>
- Consumer Package 1 without S7-EE monitor
- Consumer Package 5 without S7-EE monitor
- Consumer Package 25 without S7-EE monitor

Download

- Consumer Package 1 with S7-EE monitor<sup>3)</sup>
- Consumer Package 5 with S7-EE monitor<sup>3)</sup>
- Consumer Package 25 with S7-EE monitor<sup>3)</sup>
- Consumer Package 1 without S7-EE monitor
- Consumer Package 5 without S7-EE monitor
- Consumer Package 25 without S7-EE monitor

##### SIMATIC Energy Manager PRO SUS<sup>2)</sup>

Standard scope of supply

- For max. additional 50 tags and/or 1 Consumer Package<sup>2)</sup>
- For max. additional 100 tags and/or 5 Consumer Packages<sup>2)</sup>
- For max. additional 500 tags and/or 25 Consumer Packages<sup>2)</sup>
- For max. additional 5 000 tags and/or 100 Consumer Packages<sup>2)</sup>
- For more than 5 000 tags and/or 100 Consumer Packages<sup>2)</sup>

Download

- For max. additional 50 tags and/or 1 Consumer Package<sup>2)</sup>
- For max. additional 100 tags and/or 5 Consumer Packages<sup>2)</sup>
- For max. additional 500 tags and/or 25 Consumer Packages<sup>2)</sup>
- For max. additional 5 000 tags and/or 100 Consumer Packages<sup>2)</sup>
- For more than 5 000 tags and/or 100 Consumer Packages<sup>2)</sup>

#### Article No.

6AV6372-2DF67-1AX0

6AV6372-2DF67-1BX0

6AV6372-2DF67-1CX0

6AV6372-2DF77-1AX0

6AV6372-2DF77-1BX0

6AV6372-2DF77-1CX0

6AV6372-2DF67-1AH0

6AV6372-2DF67-1BH0

6AV6372-2DF67-1CH0

6AV6372-2DF77-1AH0

6AV6372-2DF77-1BH0

6AV6372-2DF77-1CH0

6AV6372-2DF00-OCL0

6AV6372-2DF00-ODL0

6AV6372-2DF00-OFL0

6AV6372-2DF00-OHL0

6AV6372-2DF70-OXL0

6AV6372-2DF00-OCY0

6AV6372-2DF00-ODY0

6AV6372-2DF00-OFY0

6AV6372-2DF00-OHY0

6AV6372-2DF70-0XY0

#### Article No.

##### SIMATIC B.Data to Energy Manager PRO upgrades

Standard scope of supply

- Upgrade of systems with up to 50 tags and/or 1 Consumer Package
- Upgrade of systems with up to 100 tags and/or 5 Consumer Packages
- Upgrade of systems with up to 500 tags and/or 25 Consumer Packages
- Upgrade of systems with up to 5 000 tags and/or 100 Consumer Packages
- Upgrade of systems with more than 5 000 tags and/or more than 100 Consumer Packages

Download

- Upgrade of systems with up to 50 tags and/or 1 Consumer Package
- Upgrade of systems with up to 100 tags and/or 5 Consumer Packages
- Upgrade of systems with up to 500 tags and/or 25 Consumer Packages
- Upgrade of systems with up to 5 000 tags and/or 100 Consumer Packages
- Upgrade of systems with more than 5 000 tags and/or more than 100 Consumer Packages

##### SIMATIC Energy Manager Basic/PRO TRIAL

Standard scope of supply

6AV6372-2DF07-1CX4

6AV6372-2DF07-1DX4

6AV6372-2DF07-1FX4

6AV6372-2DF07-1HX4

6AV6372-2DF77-1XX4

6AV6372-2DF07-1CH4

6AV6372-2DF07-1DH4

6AV6372-2DF07-1FH4

6AV6372-2DF07-1HH4

6AV6372-2DF77-1XH4

6AV6372-2DF17-1AX0

- <sup>1)</sup> The tag packages dynamically expand the number of tags. The total number of tags is incremented by the value of the tag package in each case.
- <sup>2)</sup> The SUS contract runs for 1 year. The contract is automatically extended by a further year unless canceled 3 months prior to expiration.
- <sup>3)</sup> The license number on the certificate is used to activate the S7 instruction; a separate license certificate is required for each machine.

Additional information is available on the Internet at:

<http://www.siemens.com/simatic-energy-manager-pro>

### Overview

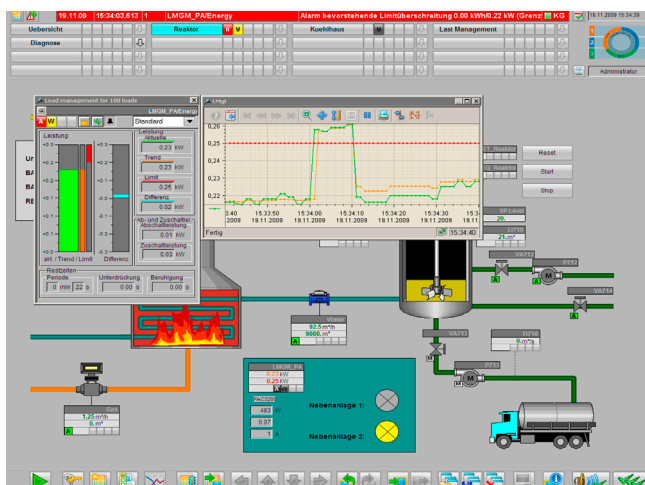

SIMATIC powerrate, as an option for WinCC / PCS 7, ensures transparency in energy consumption from the feed to the load.

SIMATIC powerrate is used in all sectors in which WinCC or PCS 7 are deployed and energy efficiency considerations play a major role. Total integration into WinCC or PCS 7 means that there is no need for a special system environment. Predefined modules and symbols give you the assurance of building on tested product components, with interfaces that support customized expansion.

SIMATIC powerrate therefore provides a solution that you can use to obtain an overview of the energy consumption of a plant easily and cost-effectively through integration in an existing SIMATIC SCADA system.

### Benefits

- Identification of energy-intensive equipment and processes to develop measures for improving energy efficiency.
- Comparison of consumption profiles for more efficient processes.
- Optimization of the company according to energy parameters, based on an evaluation of consumption and costs.
- Compliance with the contractually agreed power limits, thus preventing higher power supply costs or penalty payments.
- Integration of the 7KM PAC3200/4200 measuring devices for a clear overview of selected measured values and alarms.
- Integration of switches with an overview of the switch status and the switching possibilities.
- Accurate assignment and comparison of the consumption data of specific work processes or batches

### Design

SIMATIC powerrate comprises the following components:

- Blocks for acquiring and conditioning energy data
- Faceplates for displaying and editing energy data
- Blocks for implementing load management (calculating the trend, monitoring the limit, releasing/inhibiting loads), batch-related consumption recording and for integrating measuring instruments and switches
- Additional blocks – for example, for time synchronization, data backup, data exchange with archives
- Faceplates for displaying results and entering values (e.g. for configuration, or manually measured values)
- Excel-based reports for allocating energy data to cost centers, for batch-related evaluation and for determining and displaying the load duration curve
- Exporting data to Excel

### Function

#### Acquiring and conditioning energy data

Using ready-to-use function blocks, energy data can be acquired by any PROFIBUS-capable devices. The data can be input to the function blocks in the form of counter pulses, count values or power values. Count values can also be entered manually.

From this data, the function block calculates the power averages and the work values for a predefined period. This calculated data is subsequently saved in the WinCC archive. In addition, a final value forecast is extrapolated for the power values for each period.

A sample function (heat calculation) that can be adapted to the needs of the customer at any time by means of open interfaces has been implemented for the purpose of visualizing customized calculations.

Data from manually read counters can be entered directly into the system and used for further analysis. Absolute numerical values (entry of an absolute value instead of the difference from the previous value) can also be recorded and used in further processing.

#### Displaying energy data

The up-to-date, acquired energy data is displayed as power averages/work values for each time interval (total value for the previous interval, current value of the current interval, extrapolated value for the end of the current interval). A load trend display enables analysis of archived energy data as well as its representation in tables.

## HMI Software

### Software for energy management

#### SIMATIC powerrate

#### Function (continued)

##### Further processing of data

The archived data can be exported to Excel directly from WinCC using the export functions. The exported energy data can also be included in further customized processing. WinCC tools can be used to access the data from the WinCC archive.

##### Reports

For this purpose, selected energy data is read from archives (Tag Logging archive, user archives) from the WinCC Runtime database; using Microsoft Excel the following reports can then be generated:

- **Cost center report**  
Here the consumption can be allocated to different cost centers and the costs can be calculated on the basis of predefined tariffs. The results can be output by means of 2 reports in the form of tables or diagrams.
- **Load duration curve**  
An analysis is carried out on the basis of the archived power averages to establish how often a certain power average has occurred in a given period. It can be quickly detected from this characteristic curve whether temporary power peaks exist which can represent a possible starting point for cost savings by means of load management.
- **Batch report**  
This is used to allocate consumption to batches, whereby the data can be presented in chronological order or in order of batch name.

The generation of exports or reports can be initiated manually or automatically time-controlled (daily, weekly or monthly).

##### Load management

Contractually agreed power limits (in the case of electricity, normally the 15-minute average power value) must be observed, otherwise penalty payments may be incurred or significantly higher supply prices become due to the energy supply company. The load management feature of SIMATIC powerrate carries out cyclic trend calculations in order to issue warnings/alarms if violation of the limit is likely and to switch off loads in accordance with the given configuration should this be required. If a limit is exceeded despite this, the latest load management data is archived to enable future evaluation or analysis.

To prevent unnecessary switching operations, numerous parameters are available for adapting the load management to the current process conditions - and all this can be done conveniently via the faceplate.

For loads that are distributed over different PLCs, SIMATIC powerrate contains appropriate PLC-to-PLC communication blocks which can be used to integrate these loads into the load management system. Load management is scalable, according to the maximum number of loads to be integrated or monitored, for up to 10, 25, 50, 75 or 100 loads. Load management can be performed for different media (e.g. electricity, gas) simultaneously.

##### Batch-related consumption recording

A batch comprises all the units of a product that have been produced in one production cycle, i.e. under identical conditions. Batch-related consumption recording allows accurate recording of energy consumption for each batch. Batch-related consumption recording is possible for five types of energy each with up to 10 loads. Appropriate reports can be generated for analysis of the data (see also the batch report).

##### Integration of measuring devices 7KM PAC3200/PAC4200

If the 7KM PAC3200/PAC4200 measuring devices are integrated, selected measured values can be displayed and alarms (current, voltage, pulse frequency too high) can be generated from the digital status information and displayed.

##### Integration of switches

Switch integration via digital inputs/outputs (DI/DO) supports display of the switch status (On, Off, tripped, unplugged).

With the appropriate authorization, switching is also possible via the faceplate. Switching takes place in a 2-step operation (switch command is issued, followed by a prompt for repeated confirmation; the switch command is not forwarded to the switch until confirmation has been received).

##### WinCC Web Navigator support

Makes the powerrate functionality available over the Web.

##### Special functions

To avoid data loss in the event of a communication fault, the data is stored temporarily in a circulating buffer on the S7.



### Technical specifications

SIMATIC powerrate V4.0 SP3	
<b>Hardware requirements</b> SIMATIC powerrate can be used in the PCS 7 or WinCC SCADA environments. For installation, the respective hardware requirements of the following products apply  Released CPUs - SIMATIC powerrate is released in the PCS 7 environment for  Released CPUs - SIMATIC powerrate is released in the WinCC SCADA environment for:	<ul style="list-style-type: none"> <li>• PCS 7</li> <li>• STEP 7 and WinCC SCADA</li> </ul> <ul style="list-style-type: none"> <li>• S7-400 CPUs supported by PCS 7</li> <li>• WinAC RTX 2010 SP1 and SP2</li> </ul> <ul style="list-style-type: none"> <li>• S7-400</li> <li>• S7-300</li> <li>- SIMATIC S7 CPU 319-3 PN/DP V2.5 and higher</li> <li>- SIMATIC S7 CPU 317-2 PN/DP V2.6 and higher</li> <li>- SIMATIC S7 CPU 315-2 PN/DP V3.1 and higher</li> <li>• SIMATIC ET 200S IM151-8 PN/DP CPU V3.2 and higher</li> </ul> Firmware version V3.x or later is recommended for S7-300 controllers. CPUs with firmware version V3.2 or higher must be used for the implementation of PROFienergy I-device blocks PR3_PE_IDEV and PRx_PE_RD. <ul style="list-style-type: none"> <li>• WinAC RTX 2010 SP1 and SP2</li> </ul>
<b>Software requirements</b> You can use SIMATIC powerrate in the PCS 7 or WinCC SCADA environments. For installation, the respective software requirements of the following products apply:  The library is released for the following PCS 7 versions  The library is released for the following WinCC version with the corresponding versions of STEP 7  For use with WinCC V7.3 or V7.2, the following installations are required:  powerrate Reports has been released for the following versions	<ul style="list-style-type: none"> <li>• PCS 7</li> <li>• STEP 7 and WinCC SCADA</li> </ul> <ul style="list-style-type: none"> <li>• SIMATIC PCS 7 V8.1</li> <li>• SIMATIC PCS 7 V8.0 SP2</li> <li>• SIMATIC PCS 7 V7.1 SP4</li> </ul> <ul style="list-style-type: none"> <li>• SIMATIC WinCC V7.3 Second Edition</li> <li>• SIMATIC WinCC V7.2 Update 1 or higher (Update 2 is recommended)</li> </ul> <ul style="list-style-type: none"> <li>• WinCC minimum installation</li> <li>- Basic Process Control</li> <li>- User archives for load management and batch-oriented energy acquisition</li> <li>• WinCC add-on "AS-OS Engineering"</li> </ul> For the use of SIMATIC powerrate V4.0, WinCC must execute in integrated mode with STEP 7. <ul style="list-style-type: none"> <li>• SIMATIC NET</li> <li>• STEP 7</li> </ul> <ul style="list-style-type: none"> <li>• Microsoft Excel 2003</li> <li>• Microsoft Excel 2007</li> <li>• Microsoft Excel 2010</li> <li>• Microsoft Excel 2013</li> </ul>

### Ordering data

### Article No.

<b>SIMATIC powerrate V4.0 SP3 ES + OS Runtime<sup>1)</sup></b> Also includes: <ul style="list-style-type: none"> <li>• License for WinCC/User Archive</li> <li>• Block library PAC3200 for WinCC</li> <li>• Block library PAC3200, 3WL/3VL for PCS 7</li> </ul>	6AV6372-1DE04-0AX0
<b>SIMATIC powerrate V4.0 SP3 Upgrade</b> Upgrade V3.x to V4.0 SP3, ES + OS-RT <sup>1)</sup>	6AV6372-1DE04-0AX4
<b>SIMATIC powerrate V4.0 SP3 Update</b> Update V4.0 (SP1 or SP2) to V4.0 SP3	6AV6372-1DE04-0AX3
<b>SIMATIC powerrate V4.0 SP3 Trial License</b> Limited 30-day ES + OS Runtime license	6AV6372-1DE04-0AX7

<sup>1)</sup> For operation on a WinCC/PCS 7 OS single-user workstation or server and any number of automation systems. When using additional WinCC/PCS 7 OS single-user stations/servers, one license is required per WinCC/PCS 7 OS single-user station/server.

### More information

Additional information is available on the Internet at:

<http://www.siemens.com/simatic-powerrate>

Important information on the use of SIMATIC powerrate is available on the Internet at:

<http://support.automation.siemens.com/WW/view/en/48204134>

## HMI Software

### SIMATIC WinCC flexible

#### Introduction

#### Overview

##### ***SIMATIC WinCC flexible ES engineering software***

- Family of configuration systems with WinCC flexible/ Compact/Standard/Advanced for SIMATIC operator panels, the HMI part of SIMATIC C7 as well as for the WinCC flexible Runtime PC-based visualization software
- Runs on Windows 7 Professional, Ultimate, Enterprise / Windows 10 Professional, Enterprise
- Can be expanded by the option "WinCC flexible/ChangeControl" for version management and change logging

##### ***SIMATIC WinCC flexible Runtime visualization software***

- Modular PC-based HMI solution for single-user systems directly at the machine (further development of ProTool/ Pro RT)
- Runs on Windows 7 Professional, Ultimate, Enterprise / Windows 10 Professional, Enterprise
- Basic package for visualization, reporting and logging; can be expanded by implementing option packages
- Flexible expansion possible with VB scripts and customized ActiveX controls created with OPP (Open Platform Program)
- Can be integrated into automation solutions based on TCP/IP networks
- Expanded service concepts with remote operation, diagnostics and administration over the intranet and Internet in combination with email communication

## Overview

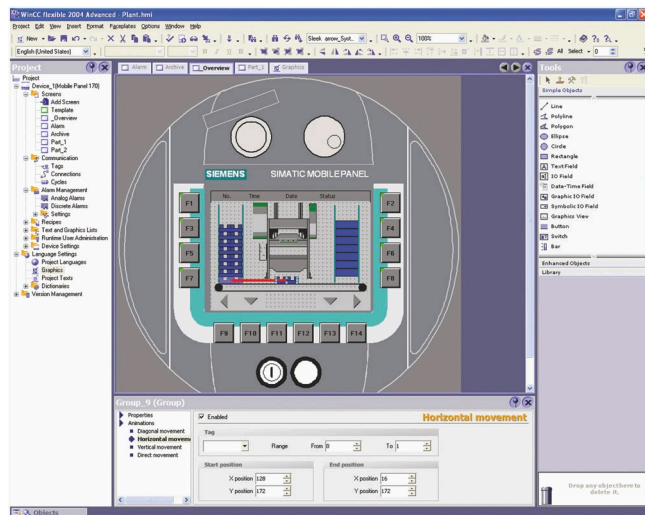

- Uniform family of engineering tools for configuring SIMATIC HMI operator panels, the operator controls of SIMATIC C7 units, SINUMERIK Panel PCs as well as the PC-based visualization software WinCC flexible Runtime.
- Runs on Windows 7 Professional, Ultimate, Enterprise / Windows 10 Professional, Enterprise
- Current version:
  - SIMATIC WinCC flexible 2008 SP5 Micro
  - SIMATIC WinCC flexible 2008 SP5 Compact
  - SIMATIC WinCC flexible 2008 SP5 Standard
  - SIMATIC WinCC flexible 2008 SP5 Advanced

## Application

SIMATIC WinCC flexible Compact/Standard/Advanced are engineering tools for configuring SIMATIC HMI operator panels, the operator controls of SIMATIC C7 units, SINUMERIK Panel PCs as well as the PC-based WinCC flexible Runtime visualization system.

Depending on the selected product, various target systems can be configured:

### WinCC flexible Compact

In addition to the target systems that are configured using WinCC flexible Micro:

- Basic Panels: KTP400 Basic, KTP600 Basic, KTP1000 Basic, TP1500 Basic
- Mobile Panels: Mobile Panel 170, Mobile Panel 177
- 70 series Panels: OP 73, OP 77A, OP 77B
- 170 series Panels: TP 170A, TP 177A, TP 170B, TP 177B, OP 170B, OP 177B
- 170 series Multi Panels: MP 177
- C7 devices: C7-635 (Touch/Key)

### WinCC flexible Standard

In addition to the target systems that are configured using WinCC flexible Compact:

- Mobile Panels: Mobile Panel 277
- 270 series panels: TP 270, TP 277, OP 270, OP 277
- 270 series Multi Panels: MP 270B, MP 277
- 370 series Multi Panels: MP 370, MP 377
- C7 devices: C7-636 (Touch/Key)

### WinCC flexible Advanced

In addition to the target systems that are configured using WinCC flexible Standard:

- Standard PC
- SIMATIC Panel PC: IPC227E, IPC227D, IPC427E, IPC427D, IPC627D, IPC827D
- SIMATIC Box PC: IPC227E, IPC227D, IPC427E, IPC427D, IPC627D, IPC827D
- SIMATIC Rack PC: IPC347E, IPC547G, IPC647D, IPC847D
- SINUMERIK Panel PC: HT8, OP08T, OP010, OP012, TP012, OP015, TP015, OP015A

For configuring panels released after the start of delivery of WinCC flexible 2008, an HSP (Hardware Support Package) is required that can be downloaded free of charge via the following link:  
<http://www.siemens.com/wincc-flexible-hsp>

## Technical specifications

System requirements (minimum requirements)	WinCC flexible Engineering Software
<b>Operating system</b>	<ul style="list-style-type: none"> <li>• Windows 7 Professional SP1, Ultimate/Enterprise SP1 (32-bit and 64-bit)</li> <li>• Windows 10 Professional, Enterprise, LTSB Enterprise (64-bit)</li> </ul>
<b>Processor</b>	Pentium 4 (or comparable) processor running at 1.6 GHz or faster
<b>Resolution</b>	1024 x 768 or higher
<b>Main memory (RAM)</b>	≥ 1 GB, ≥ 512 MB for WinCC flexible Micro
<b>Hard disk (free memory space)<sup>1)</sup></b>	≥ 2 GB <sup>2)</sup> ≥ 1.2 GB for WinCC flexible Micro <sup>3)</sup>
<b>DVD drive</b>	for software installation

<sup>1)</sup> In addition to WinCC flexible, Windows also requires free hard drive space; e.g. space should be reserved for the page file. The following formula has proven itself in the past: The size of the swap file = 3 x the size of available RAM. For further information, refer to your Windows documentation

<sup>2)</sup> When installing one language. An additional 200 MB are required for each further language. In the case of different partitions for system and configuration: System partition approx. 700 MB, project partition approx. 1.3 GB.

<sup>3)</sup> When installing one language. An additional 80 MB are required for each further language. In the case of different partitions for system and configuration: System partition approx. 600 MB, project partition approx. 600 MB.

# HMI Software

## SIMATIC WinCC flexible

### SIMATIC WinCC flexible ES

#### Ordering data

##### WinCC flexible 2008 Compact incl. SP5

- Software and documentation on DVD, floating license, license key on USB stick
- As download <sup>3)</sup>, software and license key download, floating license, email address required for delivery

6AV6611-0AA51-3CA5

6AV6611-0AA51-3CH5

##### WinCC flexible 2008 Standard incl. SP5

- Software and documentation on DVD, floating license, license key on USB stick
- As download <sup>3)</sup>, software and license key download, floating license, email address required for delivery

6AV6612-0AA51-3CA5

6AV6612-0AA51-3CH5

##### WinCC flexible 2008 Advanced incl. SP5

- Software and documentation on DVD, floating license, license key on USB stick
- As download <sup>3)</sup>, software and license key download, floating license, email address required for delivery

6AV6613-0AA51-3CA5

6AV6613-0AA51-3CH5

##### WinCC flexible /ChangeControl for WinCC flexible 2008 Compact/Standard/Advanced <sup>1) 2)</sup>

- Floating license, option, license key only
- as download <sup>3)</sup>, only license key download, floating license, email address required for delivery

6AV6613-6AA01-3AB5

6AV6613-6AA01-3AH5

#### Powerpacks

##### SIMATIC WinCC flexible Power Packs

Floating license, license key only on USB stick

- WinCC flexible 2008 Standard to 2008 Advanced
- WinCC flexible 2008 Compact to 2008 Advanced
- WinCC flexible 2008 Compact to 2008 Standard

As download <sup>3)</sup>, floating license, license key download only, email address required for delivery

6AV6613-2CD01-3AD5

6AV6613-2BD01-3AD5

6AV6612-2BC01-3AD5

- WinCC flexible 2008 Standard to 2008 Advanced

6AV6613-2CD01-3AJ5

- WinCC flexible 2008 Compact to 2008 Advanced

6AV6613-2BD01-3AJ5

- WinCC flexible 2008 Compact to 2008 Standard

6AV6612-2BC01-3AJ5

#### Article No.

#### Updates

**WinCC flexible 2008 Compact/Standard/Advanced Update 2008, 2008 SP1, SP2, SP3 -> SP5**

6AV6613-0AA51-3CU8

#### Upgrades

**SIMATIC WinCC flexible 2004/2005/2007 to SIMATIC WinCC flexible 2008 incl. SP5**

- Upgrade to WinCC flexible 2008 Compact, incl. ChangeControl option <sup>1)</sup>
- Upgrade to WinCC flexible 2008 Standard, incl. ChangeControl option <sup>1)</sup>
- Upgrade to WinCC flexible 2008 Advanced, incl. ChangeControl option <sup>1)</sup>

6AV6611-0AA51-3CE5

6AV6612-0AA51-3CE5

6AV6613-0AA51-3CE5

As download <sup>3)</sup>,

Email address required for delivery

- Upgrade to WinCC flexible 2008 Compact, incl. ChangeControl option <sup>1)</sup>
- Upgrade to WinCC flexible 2008 Standard, incl. ChangeControl option <sup>1)</sup>
- Upgrade to WinCC flexible 2008 Advanced, incl. ChangeControl option <sup>1)</sup>

6AV6611-0AA51-3CK5

6AV6612-0AA51-3CK5

6AV6613-0AA51-3CK5

<sup>1)</sup> A separate license for WinCC flexible /ChangeControl must be purchased for each engineering station

<sup>2)</sup> The ChangeControl option has not been released for integrated operation with STEP 7

<sup>3)</sup> Current information and availability regarding the new type of delivery can be found at: <http://www.siemens.com/tia-online-software-delivery>

More information is available on the Internet at:

<http://www.siemens.com/wincc-flexible>

#### Note:

Do you require a specific modification or extension to the products described here? You will find information about the Open Platform Program for the creation of user-specific functions and controls for WinCC flexible under "Customized Products".

## Overview

PC-based visualization software for single-user systems directly at the machine.

- Runs on Windows 7 Professional, Ultimate, Enterprise and Windows 10 Professional, Enterprise
- Current version: SIMATIC WinCC flexible 2008 SP5 Runtime

SIMATIC WinCC flexible Runtime is configured with the SIMATIC WinCC flexible Advanced configuration software.

## Application

SIMATIC WinCC flexible Runtime is the high-performance visualization software for simple visualization tasks at machine level. It can be used as a single-user solution for all automation applications in factory automation, process automation and building services automation.

SIMATIC WinCC flexible Runtime can be used in combination with the following operator panels:

- SIMATIC Panel PCs
  - PC IL 70/77
  - Microbox 420
  - Panel PCs 477/477B/477C
  - Panel PCs 577/577B/577C
  - Panel PCs 670/677/677B/677C
  - Panel PCs 870/877
- SINUMERIK Panel PCs
  - HT8; OP08T
  - OP010, OP012, OP015
  - TP012, TP015, OP015A
- Standard PCs with resolutions (W x H in pixels) of:
  - 4:3 format: 640 x 480, 800 x 600, 1 024 x 768, 1 280 x 1 024, 1 600 x 1 200
  - Widescreen format: 800 x 480, 1 280 x 800, 1 366 x 768, 1 440 x 900, 1 680 x 1 050, 1 920 x 1 080, 1 920 x 1 200, 1 980 x 1 080

## Design

SIMATIC WinCC flexible Runtime is available as a software package with 128, 512, 2048 or 4096 PowerTags. The term PowerTags is used exclusively to identify process variables and range pointers that have a process link to the controller. Variables without process link, constant limit values of variables, and messages (up to 4000 bit-triggered messages) are also available for additional system performance.

The range of functions of WinCC flexible Runtime includes the centralized HMI components for visualizing and reporting, and it can be expanded to suit requirements and costs by using optional packages.

SIMATIC WinCC flexible Runtime is configured with the SIMATIC WinCC flexible Advanced configuration software.

## Function

System requirements	WinCC flexible Runtime
<b>Operating system</b>	<ul style="list-style-type: none"> <li>• Windows 7 Professional / Ultimate / Enterprise (32-bit and 64-bit)</li> <li>• Windows 7 Embedded Standard, Standard with SP1 (32-bit) <sup>1)</sup></li> <li>• Windows 10 Professional, Enterprise, LTSB Enterprise</li> <li>• Windows 10 IoT LTSB Enterprise <sup>1)</sup></li> </ul>
<b>Processor <sup>4)</sup></b>	<ul style="list-style-type: none"> <li>• Minimum: Windows 7: 1 GHz</li> <li>• Recommended: Windows 7: ≥ 1 GHz</li> </ul>
<b>Graphics</b>	<ul style="list-style-type: none"> <li>• Minimum: SVGA</li> <li>• Resolution: 640 x 480 to 1600 x 1200 or 800 x 480 to 1980 x 1080</li> </ul>
<b>RAM <sup>2)</sup></b>	<ul style="list-style-type: none"> <li>• Minimum: Windows 7: 1 GB</li> <li>• Recommended: Windows 7: ≥ 1 GB</li> </ul>
<b>Hard disk (free memory space) <sup>3)</sup></b>	≥ 250 MB

<sup>1)</sup> Only on approved systems such as SIMATIC IPCs.

For more detailed information, please contact your Siemens contact person.

<sup>2)</sup> RAM requirements are determined primarily by the size of the graphics used.

<sup>3)</sup> Without taking archives into account. In addition to the space needed by WinCC flexible, Windows also requires space on the hard disk; e.g. for the swap file. The following formula has proven itself in the past: The size of the swap file = 3 x the size of the RAM. For further information, refer to your Windows documentation

<sup>4)</sup> More powerful systems (Pentium 4 and higher) may be required in order to use options

# HMI Software

## SIMATIC WinCC flexible

### SIMATIC WinCC flexible RT

#### Integration

SIMATIC WinCC flexible Runtime supports linking to:

Protocol	PC interfaces	
<b>SIMATIC S5 via AS511 (TTY)</b>		
S5-90U	COM1/COM2 <sup>13)</sup>	
S5-90U		
S5-100U (CPU 100, 102, 103)		
S5-115U (CPU 941, 942, 943, 944, 945)		
S5-135U (CPU 928A, 928B)		
S5-155U (CPU 946/947, 948)		
<b>SIMATIC S5 via PROFIBUS DP <sup>1)</sup></b>		
S5-95U/L2-DP master	CP 5512 <sup>2)</sup>	
S5-115U (CPU 941, 942, 943, 944, 945)		
S5-135U (CPU 928A, 928B)		
S5-155U (CPU 946/947, 948)		
<b>SIMATIC S7 via PPI</b>		
S7-200	CP 5612 CP 5621 <sup>1)</sup> CP 5622 CP 5613 A3 CP 5614 A3 CP 5623 CP 5624 CP 5711 PC/PPI adapter <sup>3)</sup>	
<b>SIMATIC S7 via MPI</b>		
S7-200 (except CPU 212) <sup>4)</sup>	CP 5612 CP 5621 <sup>1)</sup> CP 5622 CP 5613 A3 CP 5614 A3 CP 5623 CP 5624 CP 5711 PC adapter USB A2 <sup>6)</sup> Teleservice V6.1	
S7-300		
S7-400		
WinAC Basis (V3.0 and higher)		
WinAC RTX		
<b>SIMATIC S7 via PROFIBUS DP <sup>5)</sup></b>		
S7-215 <sup>4)</sup>		CP 5612 CP 5621 <sup>1)</sup> CP 5622 CP 5613 A3 CP 5614 A3 CP 5623 CP 5624 CP 5711
S7-300 CPUs with integral PROFIBUS-SS		
S7-300 with CP 342-5		
S7-400 CPUs with integral PROFIBUS-SS		
S7-400 with CP 443-5 or IM 467		
WinAC Basis (V3.0 and higher)		
WinAC RTX		

<sup>1)</sup> WinCC flexible Runtime is passive (DP slave); the function block required for the link is included in the scope of supply of WinCC flexible

<sup>2)</sup> For Microbox 427 and Panel PC 477/577/677 via internal MPI/DP interface

<sup>3)</sup> Only point-to-point to S7-200; no configuration download, operating systems: Windows XP; article number: 6ES7901-3CB30-0AX0

<sup>4)</sup> Constraint with regard to baud rate for S7-200; see Catalog ST 70

<sup>5)</sup> WinCC flexible RT is active; communication with S7 functions

<sup>6)</sup> Only point-to-point to S7-300/-400; no configuration download, operating systems: Windows XP or higher; article number: 6GK1571-0BA00-0AA0 (USB)

<sup>7)</sup> For Microbox 427 and Panel PC 477/577/677/877 via internal Ethernet interface

<sup>8)</sup> For further information, see Catalog PM 21

<sup>9)</sup> "SINUMERIK HMI copy license OA" option required; for further information, see Catalog NC 60

#### SIMATIC S7 via Ethernet (TCP/IP)

S7-200 with CP 243-1	CP 1612 A2 <sup>7)</sup> CP 1613 A2
S7-300 CPUs with integral Ethernet interface	
S7-300 with CP 343-1	
S7-400 CPUs with integral Ethernet interface	
S7-400 with CP 443-1	
WinAC Basis (V3.0 and higher)	
WinAC RTX	

#### SIMATIC S7 via integrated interface

WinAC Basis (V2.0 and higher)	Internal system interface
WinAC RTX	

#### SIMATIC 505 NITP

SIMATIC 500/505 RS 232/RS 422	COM1/COM2
-------------------------------	-----------

#### SIMATIC 505 via PROFIBUS DP

SIMATIC 545/555 with CP 5434	CP 5612 <sup>2)</sup> CP 5622 <sup>2)</sup>
------------------------------	--

#### SIMOTION <sup>8)</sup>

#### SINUMERIK <sup>9)</sup>

#### Third-party controllers

Allen Bradley (DF1/DH485)	COM1/COM2
Allen Bradley (Ethernet)	CP 1612 A2 <sup>7)</sup>
GE Fanuc (SNP/SNPX)	COM1/COM2
LG GLOFA GM	COM1/COM2
Mitsubishi (FX/MP4)	COM1/COM2
Modicon (Modbus)	COM1/COM2
Modicon (Modbus TCP/IP)	CP 1612 A2 <sup>7)</sup>
OMRON (Link/Multilink)	COM1/COM2

#### OPC <sup>10)</sup> <sup>12)</sup>

Data Access V2.05a (client + server)	CP 1612 A2 <sup>7)</sup>
Data Access XML V1.00 (client)	

**HTTP communication for data exchange between SIMATIC HMI (client + server) <sup>11)</sup> <sup>12)</sup>**

	CP 1612 A2 <sup>7)</sup>
--	--------------------------

<sup>10)</sup> OPC Client is included in scope of supply, the "WinCC flexible/OPC Server for WinCC flexible Runtime" license is required for the OPC Server option

<sup>11)</sup> "WinCC flexible/Sm@rtAccess for WinCC flexible Runtime" license required

<sup>12)</sup> OPC and HTTP communication are additive, i.e. can be used in conjunction with the PLC links listed above

<sup>13)</sup> Via PC cable with integrated level converter RS 232/TTY; article number: 6ES5734-1BD20

<sup>14)</sup> For information about SIMATIC Panels that support OPC/http communication, see the overview under "System interfaces".

**Integration** (continued)

**Application note**

In parallel with each and every PLC link, WinCC flexible Runtime supports the use of the OPC Client channel; this enables, for example, connection to an SNMP OPC Server for the purpose of visualizing the data stored there. The SNMP OPC Server provides a means of monitoring network components of any type (e.g. switches) which support the OPC protocol.

For further information, see Catalog IK PI.

Note:

For further information, see "Operator Control and Monitoring Devices/ System interfaces"

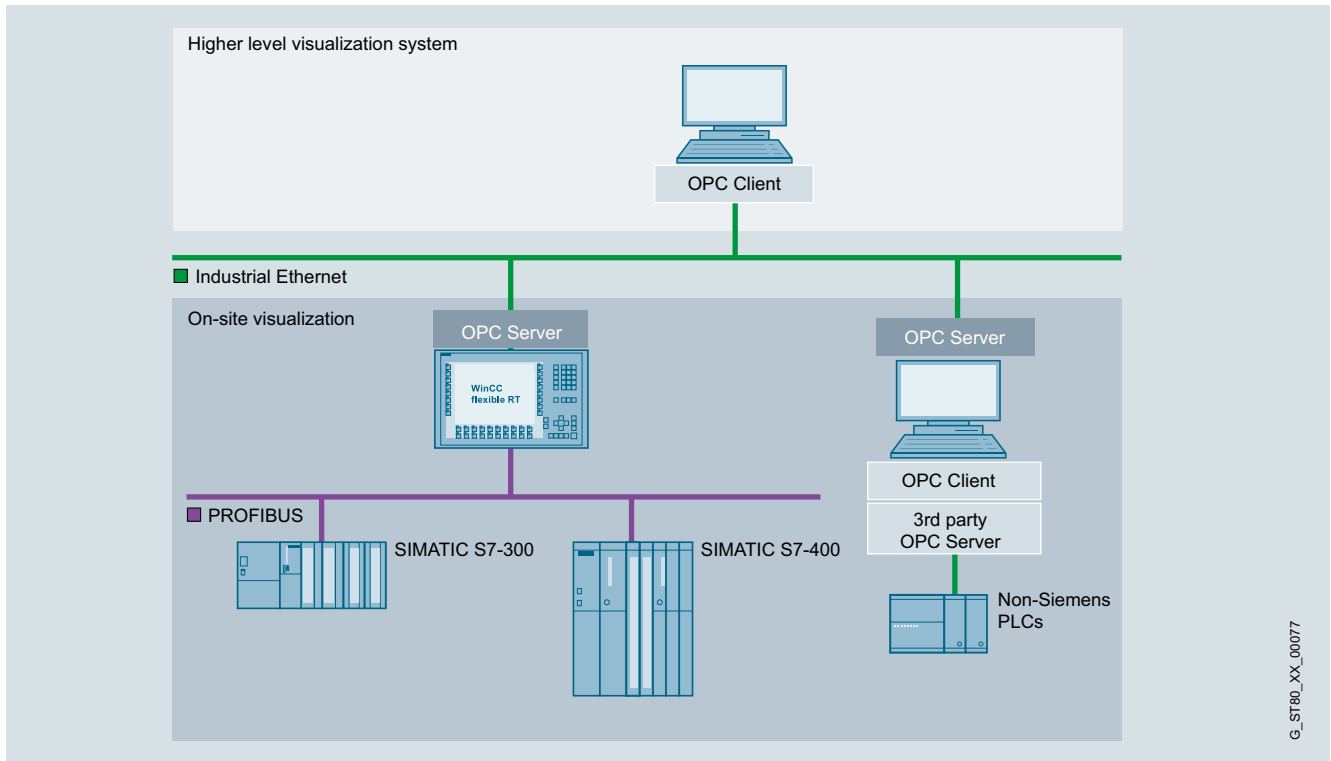

SIMATIC WinCC flexible Runtime application example

# HMI Software

## SIMATIC WinCC flexible

### SIMATIC WinCC flexible RT

#### Technical specifications

Type	SIMATIC WinCC flexible Runtime
	The specifications are maximum values
<b>Displays</b>	500
• Fields per screen	400
• Variables per screen	400
• Static text	30,000
• Graphics objects	2,000
• Complex objects per display (e.g. bars)	40
• Trends	800
• Graphics lists <sup>1)</sup>	500
• Text lists <sup>1)</sup>	500
• Number of entries in symbol tables	3,500
<b>Variables</b>	4,096 <sup>3)</sup>
<b>Messages bit-triggered / analog</b>	4,000 / 500
• Message text (number of characters)	80
• Number of process values per message	8
• Size of message buffer	1,024
• Pending message events	500
<b>Archives <sup>4)</sup></b>	100
• Archivable data	Process data, messages
• Max. number of entries per archive (incl. all archive segments)	500,000
• Archive types	Short-term archive, sequence archive (max. 400 per archive)
• Data storage format	CSV (Comma Separated Variable), RDB (Runtime Data Base), interface to MS SQL database
<b>Recipes<sup>4)</sup></b>	1,000
• Elements per recipe	2,000 <sup>3)</sup>
• Data records per recipe	5,000 <sup>2)</sup>
<b>Password protection</b>	
• User rights	32
• Number of user groups	50
<b>Visual Basic scripts</b>	200
<b>Online languages, max.</b>	16
<b>Communication</b>	
SIMATIC S7 MPI interface/ PROFIBUS DP interface	
• Number of connectable stations, max.	Depending on the scope of the configuration (communication) from the point of view of WinCC flexible Runtime, as many as 8 connections are possible
SIMATIC S7 PPI interface	
• Number of connectable stations, max.	1 from viewpoint of WinCC flexible Runtime
SIMATIC S5 PROFIBUS DP interface	
• Number of connectable stations, max.	1 from viewpoint of WinCC flexible Runtime
Multi-protocol operation	Yes, OPC Client or SIMATIC HMI HTTP protocol are additive, i.e. can be used in conjunction with other PLC links

<sup>1)</sup> Together only 500 text and graphics lists

<sup>2)</sup> Dependent on memory medium used

<sup>3)</sup> Dependent on number of licensed PowerTags

<sup>4)</sup> Option for SIMATIC WinCC flexible Runtime. For further information, refer to "WinCC flexible options".

#### Ordering data

#### Article No.

##### SIMATIC WinCC flexible 2008 Runtime

for PC systems; software and documentation on DVD, including software of the options for PC systems <sup>1)</sup>; Single license, license key on USB stick for:

- 128 PowerTags (RT 128)
- 512 PowerTags (RT 512)
- 2 048 PowerTags (RT 2 048)
- 4 096 PowerTags (RT 4 096)

as download <sup>2)</sup>

Single license, software and license key download, email address required for delivery.

- 128 PowerTags
- 512 PowerTags
- 2 048 PowerTags
- 4 096 PowerTags

**6AV6613-1BA51-3CA0**  
**6AV6613-1DA51-3CA0**  
**6AV6613-1FA51-3CA0**  
**6AV6613-1GA51-3CA0**

##### Powerpacks

##### SIMATIC WinCC flexible 2008 Runtime

Single license, license key only on USB stick for PowerTags from

- 128 to 512 PowerTags
- 128 to 2 048 PowerTags
- 128 to 4 096 PowerTags
- 512 to 2 048 PowerTags
- 512 to 4 096 PowerTags
- 2 048 to 4 096 PowerTags

as download <sup>2)</sup>

Single license, license key download only, email address required for delivery.

- 128 to 512 PowerTags
- 128 to 2 048 PowerTags
- 128 to 4 096 PowerTags
- 512 to 2 048 PowerTags
- 512 to 4 096 PowerTags
- 2 048 to 4 096 PowerTags

**6AV6613-4BD01-3AD0**  
**6AV6613-4BF01-3AD0**  
**6AV6613-4BG01-3AD0**  
**6AV6613-4DF01-3AD0**  
**6AV6613-4DG01-3AD0**  
**6AV6613-4FG01-3AD0**

**6AV6613-4BD01-3AJ0**  
**6AV6613-4BF01-3AJ0**  
**6AV6613-4BG01-3AJ0**  
**6AV6613-4DF01-3AJ0**  
**6AV6613-4DG01-3AJ0**  
**6AV6613-4FG01-3AJ0**



Ordering data	Article No.	Article No.
<b>Updates</b>		
<b>SIMATIC WinCC flexible 2008 Runtime Update 2008, 2008 SP1, SP2, SP3 -&gt; SP5</b>	<b>6AV6613-1XA51-3CU8</b>	
<b>Upgrades</b>		
<b>SIMATIC WinCC flexible 2004/2005/2007 Runtime to SIMATIC WinCC flexible 2008 Runtime</b>		
Upgrade to SIMATIC WinCC flexible Runtime 2008 PowerTags including runtime options for: WinCC flexible /Archives; WinCC flexible /Recipes; WinCC flexible /Audit; WinCC flexible /Sm@rtAccess; WinCC flexible /OPC-Server; WinCC flexible /ProAgent		
<ul style="list-style-type: none"> <li>• Software and documentation on DVD, single license, license key on USB stick</li> <li>• as download <sup>2)</sup>, software and license key download, single license, email address required for delivery</li> </ul>	<b>6AV6613-1XA51-3CE0</b>	
	<b>6AV6613-1XA51-3CK0</b>	
<b>Upgrade of the SIMATIC WinCC flexible Panel options:</b>		
WinCC flexible /Audit for SIMATIC Panel; WinCC flexible /Sm@rtAccess for SIMATIC Panel; WinCC flexible /Sm@rtService for SIMATIC Panel; WinCC flexible /OPC-Server for SIMATIC Multi Panel; WinCC flexible /ProAgent for SIMATIC Multi Panel		
<ul style="list-style-type: none"> <li>• only license key on USB stick, single license</li> <li>• as download <sup>2)</sup>, only license key download, single license, email address required for delivery</li> </ul>	<b>6AV6618-7XX01-3AF0</b>	
	<b>6AV6618-7XX01-3AK0</b>	
		<b>Communication via Industrial Ethernet</b>
		<b>SIMATIC NET HARDNET-IE S7 V12</b>
		Software for S7 communication and open communication; OPC, PG/OP communication, configuring software; up to 120 connections; Single License for 1 installation of runtime software, software and electronic manual on DVD
		<ul style="list-style-type: none"> <li>• Single license for 1 installation</li> <li>• Software Update Service for one year, with automatic extension; requirement: Current software version</li> <li>• Upgrade S7-1613 from V6.4 to S7-1613 V8.0 SP1</li> <li>• Upgrade S7-1613 from V6.0, V6.1, V6.2 or V6.3 to S7-1613 V8.0 SP1</li> </ul>
		<b>6GK1716-1CB12-0AA0</b>
		<b>6GK1716-1CB00-3AL0</b>
		<b>6GK1716-1CB00-3AE0</b>
		<b>6GK1716-1CB00-3AE1</b>
		<b>Communication via PROFIBUS</b>
		<b>CP 5613 A3</b>
		PCI card (32-bit) for connecting a PC to PROFIBUS (communications software must be ordered separately)
		<b>6GK1561-3AA02</b>
		<b>CP 5614 A3</b>
		PCI card (32-bit) for connecting a PC to PROFIBUS (communications software must be ordered separately)
		<b>6GK1561-4AA02</b>
		<b>SIMATIC NET PB S7-5613 V8.0 SP1</b>
		Software for S7 communication, incl. PG and FDL protocol, OPC server and NCM PC; Runtime sw, software and electronic manual on USB flash drive, license key on diskette, Class A, for 32-bit Windows 7 Professional/Ultimate for up to 4 CP 5613 A2, CP5614 A2, CP 5603 / CP 5623 / CP 5624;
		<ul style="list-style-type: none"> <li>• Software Update Service for one year, with automatic extension; requirement: Current software version</li> <li>• Upgrade S7-5613 from V6.4 to S7-5613 V8.0 SP1</li> <li>• Upgrade S7-5613 from V6.0, V6.1, V6.2 or V6.3 to S7-5613 V8.0 SP1</li> </ul>
		<b>6GK1713-5CB00-3AL0</b>
		<b>6GK1713-5CB00-3AE0</b>
		<b>6GK1713-5CB00-3AE1</b>
		<b>CP 5612</b>
		PCI card (32-bit) for connecting a PG/PC to PROFIBUS (communications software included in WinCC flexible basic package)
		<b>6GK1561-2AA00</b>
		<b>CP 5622</b>
		PCI Express X1 card (32-bit) for connection of PG/PC to PROFIBUS or MPI (communications software included in WinCC flexible basic package)
		<b>6GK1562-2AA00</b>
		<b>CP 5711</b>
		USB adapter (USB V2.0) for connecting a PG/notebook to PROFIBUS or MPI (communications software included in WinCC basic package)
		<b>6GK1571-1AA00</b>
		<b>SIMATIC S7, MPI cable</b>
		For linking SIMATIC S7 and PG via MPI
		<b>6ES7901-0BF00-0AA0</b>

- 1) Runtime licenses for WinCC flexible Runtime options must be purchased separately for each target system.
- 2) Current information and availability regarding the new type of delivery can be found at: <http://www.siemens.com/tia-online-software-delivery>

More information is available on the Internet at:

<http://www.siemens.com/wincc-flexible>

## HMI Software

### SIMATIC WinCC flexible

#### SIMATIC WinCC flexible options

##### Overview

##### **Option for SIMATIC WinCC flexible Engineering**

###### SIMATIC WinCC flexible /ChangeControl

WinCC flexible/ChangeControl enables consistent backup of configuration data. The history of changes can be verified down to the last detail for applications requiring interruption-free proof for the complete life cycle of a product.

##### **Options for SIMATIC Panels/Multi Panels and SIMATIC WinCC flexible Runtime**

###### SIMATIC WinCC flexible/ Archives

Archiving of alarms and process values.

###### SIMATIC WinCC flexible /Recipes

Generation and management of data records for machine or production data

###### SIMATIC WinCC flexible /Audit

Recording of operator actions in an Audit Trail

- Audit supports users in meeting special quality requirements, e.g.
  - Production plant requiring validation according to 21 CFR Part 11 (Food Drug Administration law)
  - In respect of traceability according to EU 175/2002 (EU directive)

###### SIMATIC Logon for WinCC flexible

Option for connecting PCs with SIMATIC WinCC flexible Runtime and SIMATIC Panels to central user administration.

###### SIMATIC WinCC flexible /Sm@rtAccess

- Flexible solution for access to HMI systems and process data from any location
- Communication between different SIMATIC HMI systems

###### SIMATIC WinCC flexible /Sm@rtService

- Remote maintenance and servicing of machines and plants via Internet/intranet
- Flexible solution for remote access to machines and plant

###### SIMATIC WinCC flexible /OPC server

- Incorporation of automation components from different vendors into a single automation concept
- Communication for data exchange between HMI systems and/or higher-level control system

###### SIMATIC WinCC flexible /ProAgent

- Precise and rapid process fault diagnostics in plant and machines for SIMATIC S7 and SIMATIC HMI
- Standardized diagnostics concept for various SIMATIC components
- No further configuration overhead for diagnostics functionality

Overview

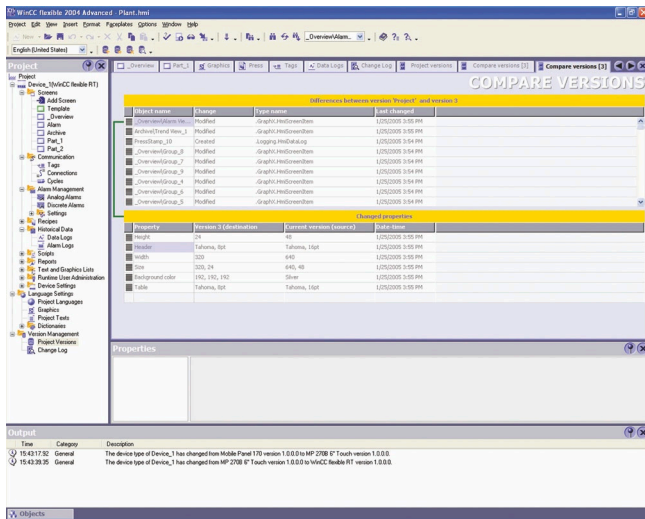

- Options for the versioning of configuration data and for tracing configuration changes (e.g. as verification in regulated sectors)
- For the engineering tool SIMATIC WinCC flexible Compact/Standard/Advanced
- One license is required for each configuration computer

Benefits

- Consistent backup of configuration data
  - Delivered versions, approved reference states or development stages are managed in a database.
  - Changes to project data can be integrated without problem into the version management using new versions. A rollback is possible at any time.
- Tracing of configuration changes
  - The history of changes can be verified down to the last detail for applications requiring interruption-free proof for the complete life cycle of a product.

Ordering data

Article No.

WinCC flexible /ChangeControl for WinCC flexible 2008 Compact/Standard/Advanced<sup>1)</sup>

- Floating license, license key only on USB stick as download<sup>2)</sup>

6AV6613-6AA01-3AB5

- Floating license, only license key download; email address required for delivery

6AV6613-6AA01-3AH5

<sup>1)</sup> The ChangeControl option has not been released for integrated operation with STEP 7.

<sup>2)</sup> Current information and availability regarding the new type of delivery can be found at: <http://www.siemens.com/tia-online-software-delivery>

More information

Note:

Do you need a specific modification or option for the products described here? Then look up "Customized products", where you will find information about the Open Platform Program for the creation of user-specific functions and controls for WinCC flexible.

# HMI Software

SIMATIC WinCC flexible

SIMATIC WinCC flexible options

## WinCC flexible /Archives

### Overview

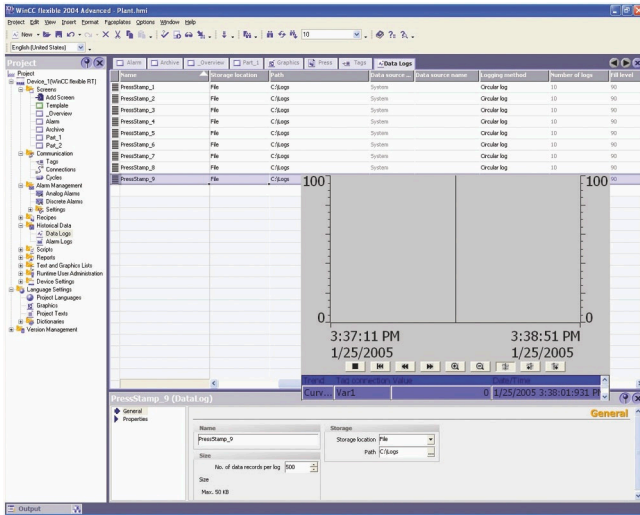

- Option for SIMATIC WinCC flexible Runtime for archiving process values and messages
- Archiving of process values and messages supports the acquisition and processing of process data from an industrial plant or machine. Evaluation of the archived process data provides information about the operating states of the plant or machine
- One license is required per operator station (no license is required for SIMATIC Panels/Multi Panels)

### Technical specifications

Type	WinCC flexible /Archives
	The specifications are maximum values
<b>Execution platform</b>	SIMATIC WinCC flexible Runtime
<b>Archives</b>	100
• Archivable data	Process values, messages
• Cyclical trigger for archiving process values (variables)	1 s
• Max. number of entries per archive (incl. sequence archive)	500,000 <sup>1)</sup>
• Archive types	<ul style="list-style-type: none"> <li>• Circulating archive</li> <li>• Sequence archive (max. 400 per archive)</li> </ul>
• Data storage format	CSV ( <b>C</b> omma <b>S</b> eparated <b>V</b> ariable), RDB ( <b>R</b> untime <b>D</b> ata <b>B</b> ase) and interface to Microsoft SQL database (database not included in scope of delivery)

<sup>1)</sup> Dependent on memory medium used

### Ordering data

### Article No.

#### WinCC flexible /Archives for WinCC flexible 2008 Runtime <sup>1)</sup>

Single license, license key only on USB stick

- Single license, license key only on USB stick

**6AV6618-7ED01-3AB0**

as download <sup>2)</sup>

- Single license, license key download only; email address required for delivery

**6AV6618-7ED01-3AH0**

#### WinCC flexible /Archives+ Recipes for WinCC flexible 2008 Runtime <sup>1)</sup>

- Single license for each option, license key only on USB stick

**6AV6618-7GD01-3AB0**

as download <sup>2)</sup>

- Single license for each option, license key download only; email address required for delivery

**6AV6618-7GD01-3AH0**

<sup>1)</sup> One license is required for each operator station. A license is not required for the engineering system for configuring the runtime option.

<sup>2)</sup> Current information and availability regarding the new type of delivery can be found at: <http://www.siemens.com/tia-online-software-delivery>

### More information

#### Note

Do you need a specific modification or option for the products described here? Then look up "Customized products", where you will find information about the Open Platform Program for the creation of user-specific functions and controls for WinCC flexible.

## Overview

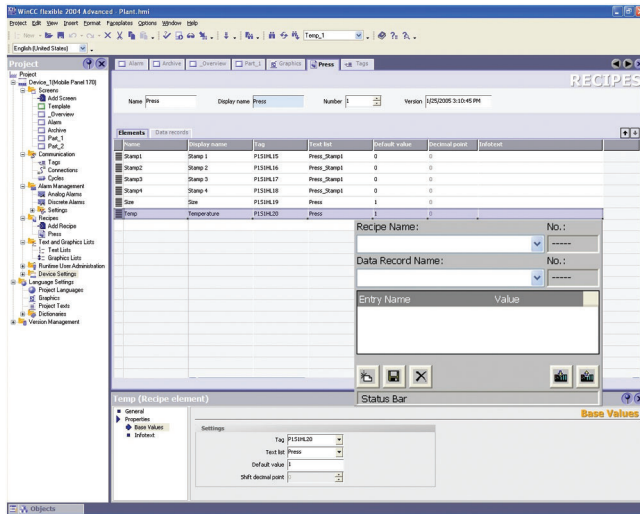

- Option for SIMATIC WinCC flexible Runtime for managing data records in recipes that contain related machine or production data
- The data in a data set can be transferred, for example, from the control unit to the PLC to switch production to a different product variant
- One license is required per operator station (no license is required for SIMATIC Panels/Multi Panels)

## Technical specifications

Type	WinCC flexible /Recipes
	The specifications are maximum values
<b>Execution platform</b>	SIMATIC WinCC flexible Runtime
<b>Recipes</b>	1000
• Entries per recipe	2000 <sup>1)</sup>
• Data records per recipe	5000 <sup>2)</sup>
• User data length in bytes per data record	8000 KB <sup>2)</sup>

<sup>1)</sup> Dependent on number of licensed PowerTags  
<sup>2)</sup> Dependent on memory medium used

## Ordering data

## Article No.

### WinCC flexible /Recipes for WinCC flexible 2008 Runtime <sup>1)</sup>

- Single license, license key only on USB stick
- as download <sup>2)</sup>  
Single license, license key download only; email address required for delivery

6AV6618-7FD01-3AB0

6AV6618-7FD01-3AH0

### WinCC flexible /Archives+ Recipes for WinCC flexible 2008 Runtime <sup>1)</sup>

- Single license per option, license key only on USB stick
- as download <sup>2)</sup>  
Single license for each option, license key download only; email address required for delivery

6AV6618-7GD01-3AB0

6AV6618-7GD01-3AH0

<sup>1)</sup> One license is required for each operator station. A license is not required for the engineering system for configuring the Runtime option.

<sup>2)</sup> Current information and availability regarding the new type of delivery can be found at: <http://www.siemens.com/tia-online-software-delivery>

## More information

### Note:

Do you need a specific modification or option for the products described here? Then look up "Customized products", where you will find information about the Open Platform Program for the creation of user-specific functions and controls for WinCC flexible.

**HMI Software**

SIMATIC WinCC flexible

SIMATIC WinCC flexible options

**WinCC flexible /Audit****Overview**

- Option for SIMATIC WinCC flexible Runtime as well as SIMATIC Panels for recording operations in an audit trail, and electronic signature
- The audit trail features a safety mechanism that indicates subsequent manipulation.
- An easy-to-use configuration option included as standard in WinCC flexible enables you to set:
  - The operator actions to be recorded in the audit trail during runtime
  - The important operator actions requiring electronic signature/comments during runtime
- The audit option combined with the WinCC flexible ES ChangeControl option supports the user with plant validation
- Available for the following SIMATIC HMI systems: TP/OP 270, TP/OP 277, MP 270B, MP 277, MP 370, MP 377, WinCC flexible Runtime
- A license is required for every operator control unit (panel or PC)

**Technical specifications**

	<b>WinCC flexible /Audit</b>
Archive for Audit Trail use on the Panel	<ul style="list-style-type: none"> <li>• Plug-in flash memory card on the panel</li> <li>• In the higher-level PC (memory medium) connected to the panel via Ethernet</li> </ul>
Archive for Audit Trail use of WinCC flexible Runtime	On the PC (storage medium)
<b>Execution platform</b>	
SIMATIC Panels	Mobile Panel 277, TP/OP 270, TP/OP 277
SIMATIC Multi Panels	MP 270B, MP 277, MP 370, MP 377
PCs	SIMATIC WinCC flexible Runtime

**Ordering data****Article No.****WinCC flexible /Audit for SIMATIC Panels <sup>1)</sup>**

- Single license, license key only on USB stick

**6AV6618-7HB01-3AB0**

- as download <sup>2)</sup>

Single license, license key download only; email address required for delivery

**6AV6618-7HB01-3AH0****WinCC flexible /Audit for WinCC flexible Runtime 2008 <sup>1)</sup>**

- Single license, license key only on USB stick

**6AV6618-7HD01-3AB0**

- as download <sup>2)</sup>

Single license, license key download only; email address required for delivery

**6AV6618-7HD01-3AH0**

<sup>1)</sup> One license is required for each operator console. A license is not required for the engineering system for configuring the runtime option.

<sup>2)</sup> Current information and availability regarding the new delivery package can be found at: <http://www.siemens.com/tia-online-software-delivery>

**More information**Note:

Do you need a specific modification or option for the products described here? Then look up "Customized products", where you will find information about the Open Platform Program for the creation of user-specific functions and controls for WinCC flexible.

#### Overview

- Option for connecting PCs with SIMATIC WinCC flexible Runtime and SIMATIC Panels to central user administration SIMATIC Logon.
- Creates user administration on a central computer to which one or more WinCC flexible stations can be connected over Ethernet.
- SIMATIC Logon for WinCC flexible supports the user in combination with the /Audit and /ChangeControl options in meeting requirements in accordance with FDA 21 CFR Part 11 and EU178.

#### Design

SIMATIC Logon and SIMATIC Logon Remote Access are installed on a central station.

The following WinCC flexible stations are connected to the central station via Ethernet network:

- PCs with WinCC flexible Runtime
- SIMATIC Panels from the 177 series or higher (panels with Ethernet interface)

#### Licensing

The following licenses are required:

- SIMATIC Logon basic license
- SIMATIC Logon Remote Access license (3-pack license 10-pack license); more than one SIMATIC Logon Remote Access license can be installed.

The number of connectable stations depends on the SIMATIC Logon Remote Access licenses used. This number is the total of the connections provided by the individual licenses. As an example: Two installed licenses for 10 enable the connection of 20 stations to the central station.

#### Technical specifications

SIMATIC Logon for WinCC flexible	
<b>Execution platform</b>	
SIMATIC Panels	Mobile Panel 177 PN; Mobile Panel 277, TP/OP 177B PN/DP, TP/OP 277
SIMATIC Multi Panels	MP 177, MP 277, MP 377
PCs	WinCC flexible Runtime

#### Ordering data

#### Article No.

##### SIMATIC Logon V1.5

Basic license;  
for panels or WinCC flexible  
Runtime stations, the correspond-  
ing number of additional SIMATIC  
Logon Remote Access licenses is  
required.

6ES7658-7BX51-0YA0

##### SIMATIC Logon Upgrade to V1.5

##### SIMATIC Logon Remote Access for WinCC flexible (3 clients)

Remote access for 3 WinCC flexible  
2008 clients; single license for  
3 remote access clients;  
type of delivery: CD, license key  
disk, Certificate of License, Terms  
and Conditions. The number of  
licensed clients is determined  
based on the amount of installed  
SIMATIC Logon remote access  
licenses.

6ES7658-7BX51-0YE0

6ES7658-7BA00-2YB0

##### SIMATIC Logon Remote Access for WinCC flexible (10 clients)

Remote access for  
10 WinCC flexible 2008 clients;  
single license for 10 remote access  
clients; type of delivery:  
CD, license key disk, Certificate  
of License, Terms and Conditions  
The number of licensed clients is  
determined based on the amount of  
installed SIMATIC Logon remote  
access licenses.

6ES7658-7BB00-2YB0

#### More information

##### Note:

Do you need a specific modification or addition to the products described here? Then take a look under "Customer-specific products". There, we provide information on the Open Platform Program for creating your own functions or Controls for WinCC flexible.

## HMI Software

SIMATIC WinCC flexible

SIMATIC WinCC flexible options

### WinCC flexible /Sm@rtAccess

#### Overview

- Option for SIMATIC WinCC flexible Runtime plus SIMATIC Panels for communication between various SIMATIC HMI systems.
- Available for the following SIMATIC HMI systems:
  - Mobile Panel 177 PN, Mobile Panel 277
  - TP 177B PN/DP, OP 177B PN/DP
  - TP 270, TP 277, OP 270, OP 277
  - MP 177, MP 270B, MP 277, MP 370, MP 377
  - WinCC flexible Runtime
- Communication between HMI systems is established on the basis of Ethernet networks, or via the intranet/Internet:
  - Read and write access to tags;
  - One SIMATIC HMI system can be remotely controlled or monitored from another one;

- Licensing: The license "WinCC flexible/Sm@rtAccess for Panel" or "WinCC flexible/Sm@rtAccess for WinCC flexible Runtime" must be installed on both the server and client HMI device.

#### Note:

If the operator stations are accessed using the Sm@rtAccess option, suitable protective measures (including IT security such as network segmentation) should be taken in order to ensure safe operation of the system.

You will find more information on the topic of Industrial Security on the Internet at:

<http://www.siemens.com/industrialsecurity>

#### Technical specifications

Type	WinCC flexible /Sm@rtAccess
	The specifications are maximum values
<b>Execution platform</b>	
• SIMATIC Panels	Mobile Panel 177 PN, Mobile Panel 277, TP/OP 177B PN/DP, TP/OP 270, TP/OP 277
• SIMATIC Multi Panels	MP 177, MP 270B, MP 277, MP 370, MP 377
• PCs	WinCC flexible Runtime
<b>Sm@rtAccess</b>	
<b>SIMATIC HMI HTTP protocol</b>	
Number of connections for one client	
• Mobile Panel 177 PN, TP/OP 177 B PN/DP, MP 177 as HTTP server	4
• Mobile Panel 277, TP/OP 270, TP/OP 277, MP 270B, MP 277, MP 370, MP 377 as HTTP server	8
• for WinCC flexible Runtime	16

Sm@rtAccess	Sm@rtClient concept
Number of Sm@rtClients that can connect to a Sm@rtServer at the same time <sup>1) 2)</sup>	
• Mobile Panel 177 PN, TP/OP 177B PN/DP, MP 177 as Sm@rtServer	2 clients
• Mobile Panel 277, TP/OP 270, TP/OP 277, MP 270B, MP 277 as Sm@rtServer	3 clients for 6" devices 2 clients for 8" and 10" devices
• MP 370, MP 377 as Sm@rtServer	3 clients for 12" devices 2 clients for 15" devices 1 client for 19" devices
• for WinCC flexible Runtime as Sm@rtServer	5 clients
Number of Sm@rtClient displays per screen	
• for Panels/Multi Panels	1
• for WinCC flexible Runtime	2

<sup>1)</sup> Including 1 Service Client

<sup>2)</sup> The Sm@rtServer and the WinCC flexible/Pro Agent option cannot be used simultaneously on OP/TP/MP 270/370. Parallel operation of the runtime options ProAgent, Sm@rtAccess and Sm@rtService is possible in the context of the MP 277 8" and 10" devices, Mobile Panel 277 as well as the MP 377. Limitation: a maximum of 2 clients can be connected simultaneously to a Sm@rtServer.

#### Ordering data

##### WinCC flexible /Sm@rtAccess for SIMATIC Panel<sup>1)</sup>

- Single license, license key only on USB stick
- download<sup>2)</sup>  
Single license, license key download only; E-mail address required for the delivery

6AV6618-7AB01-3AB0

6AV6618-7AB01-3AH0

##### WinCC flexible /Sm@rtAccess for WinCC flexible 2008 Runtime<sup>1)</sup>

- Single license, license key only on USB stick
- download<sup>2)</sup>  
Single license, license key download only; E-mail address required for the delivery

6AV6618-7AD01-3AB0

6AV6618-7AD01-3AH0

<sup>1)</sup> The license must be installed on the server and on the client HMI device. Server applications are the options Sm@rtServer, HTTP-Server and SOAP-Server. Client applications are the screen object Sm@rtClient display, and the utilization of the communication driver HTTP protocol. A license is not required for the engineering system for configuring the runtime option.

<sup>2)</sup> Current information and availability regarding the new delivery package can be found at: <http://www.siemens.com/tia-online-software-delivery>

#### Note:

Do you need a specific modification or option for the products described here? Then look up "Customized products", where you will find information about the Open Platform Program for the creation of user-specific functions and controls for WinCC flexible.



#### Overview

- Option for SIMATIC WinCC flexible Runtime and SIMATIC Panels for remote maintenance and servicing of machines/plants via the Internet/intranet
- Available for the following SIMATIC HMI systems:
  - Mobile Panel 177 PN, Mobile Panel 277
  - TP 177B PN/DP, OP 177B PN/DP
  - TP 270, TP 277, OP 270, OP 277
  - MP 177, MP 270B, MP 277, MP 370, MP 377
  - WinCC flexible Runtime
- Licensing  
The "WinCC flexible /Sm@rtService for Panel" license or "WinCC flexible /Sm@rtService for WinCC flexible Runtime" license must be installed on the operator panels that use one of the following options/functions: Sm@rtServer, HTML pages (mini-Web server), e-mail.

#### Note:

If the operator stations are accessed using the Sm@rtService option, suitable protective measures (including IT security such as network segmentation) should be taken in order to ensure safe operation of the system.

You will find more information on the topic of Industrial Security on the Internet at:

<http://www.siemens.com/industrialsecurity>

#### Application

- Remote maintenance and servicing of machines and plants via Internet/Intranet
- Calling of system information, control of target systems, and updating of data sets via Internet/Intranet
- Automatic sending of emails to experts for fast elimination of faults

#### Technical specifications

Type	WinCC flexible /Sm@rtService
<b>Execution platform</b>	
• SIMATIC Panels	Mobile Panel 177 PN, Mobile Panel 277, TP 177B PN/DP, OP 177B PN/DP, TP/OP 270, TP/OP 277
• SIMATIC Multi Panels	MP 177, MP 270B, MP 277, MP 370, MP 377
• PCs	SIMATIC WinCC flexible Runtime
<b>Sm@rtService <sup>1)</sup></b>	
Remote access via	Internet Explorer V6.0 SP1 and higher
HTML pages	
• for Panels/Multi Panels	HTML V1.1 (no support for ActiveX, Java, ASP)
• for WinCC flexible Runtime	HTML V1.1
Sending emails	<ul style="list-style-type: none"> <li>via SMTP server</li> <li>Subject, message texts with 250 characters of text per email; date/time of message, message no.</li> </ul>

<sup>1)</sup> The Sm@rtServer and the WinCC flexible/ProAgent option cannot be used simultaneously on OP/TP/MP 270/370. Parallel operation of the runtime options ProAgent, Sm@rtAccess and Sm@rtService is possible in the context of the MP 277 8" and 10" devices, Mobile Panel 277 as well as the MP 377. Limitation: a maximum of 2 clients can be connected with a Sm@rtServer.

#### Ordering data

#### Article No.

##### WinCC flexible /Sm@rtService for SIMATIC Panels <sup>1)</sup>

- Single license, license key only on USB stick
- download <sup>2)</sup>  
Single license, license key download only; E-mail address required for the delivery

6AV6618-7BB01-3AB0

6AV6618-7BB01-3AH0

##### WinCC flexible /Sm@rtService for WinCC flexible Runtime 2008 <sup>1)</sup>

- Single license, license key only on USB stick
- download <sup>2)</sup>  
Single license, license key download only; E-mail address required for the delivery

6AV6618-7BD01-3AB0

6AV6618-7BD01-3AH0

<sup>1)</sup> The "WinCC flexible /Sm@rtService for Panel" license or "WinCC flexible /Sm@rtService for WinCC flexible Runtime" license must be installed on the operator panels that use one of the following options: Sm@rtServer, HTML pages, e-mail. The remote service PC and engineering system do not require a license for configuration of the Runtime option.

<sup>2)</sup> Current information and availability regarding the new type of delivery can be found at: <http://www.siemens.com/tia-online-software-delivery>

#### More information

#### Note:

Do you need a specific modification or option for the products described here? Then look up "Customized products", where you will find information about the Open Platform Program for the creation of user-specific functions and controls for WinCC flexible.

## HMI Software

SIMATIC WinCC flexible

SIMATIC WinCC flexible options

### WinCC flexible /OPC-Server

#### Overview

- Option for SIMATIC WinCC flexible Runtime as well as Multi Panels for communication with applications from different vendors (e.g. MES, ERP, or applications in the office sector)
- Available for the following SIMATIC HMI systems:
  - Mobile Panel 277, MP 270B, MP 277, MP 370, MP 377 (use of OPC on XML basis)
  - WinCC flexible Runtime (use of OPC based on DCOM)
- One license is required for each operator station.

#### Application

##### OPC Foundation

<http://www.opcfoundation.org>

#### Technical specifications

Type	WinCC flexible /OPC-Server
	The specifications are maximum values
<b>Execution platform</b>	
<ul style="list-style-type: none"> <li>• SIMATIC Panels</li> <li>• SIMATIC Multi Panels</li> <li>• PCs</li> </ul>	Mobile Panel 277 MP 270B, MP 277, MP 370, MP 377 SIMATIC WinCC flexible Runtime
<b>OPC-Server</b>	
<ul style="list-style-type: none"> <li>• XML server for Multi Panels</li> <li>• DCOM server for WinCC flexible Runtime</li> <li>• Number of connections that an OPC server can accommodate</li> </ul>	Supports the OPC XML Data Access specification V1.0 <sup>1)</sup> Supports the OPC Data Access specification V1.0a and V2.0 8

<sup>1)</sup> Data access via XML has a functional scope that is similar to OPC Data Access. A software adapter is required that must be installed on the OPC client PC to enable DCOM-based OPC clients to access the OPC XML server without any modification. The software adapter is supplied with WinCC flexible Engineering and Runtime.

#### Ordering data

#### Article No.

##### WinCC flexible /OPC-Server for SIMATIC Multi Panels <sup>1)</sup>

- Single license, license key only on USB stick
- download <sup>2)</sup>  
Single license, license key download only; E-mail address required for the delivery

6AV6618-7CC01-3AB0

6AV6618-7CC01-3AH0

##### WinCC flexible /OPC-Server for WinCC flexible Runtime 2008 <sup>1)</sup>

- Single license, license key only on USB stick
- download <sup>2)</sup>  
Single license, license key download only; E-mail address required for the delivery

6AV6618-7CD01-3AB0

6AV6618-7CD01-3AH0

<sup>1)</sup> One license is required for each operator station. A license is not required for the engineering system for configuring the Runtime option.

<sup>2)</sup> Current information and availability regarding the new delivery package can be found at: <http://www.siemens.com/tia-online-software-delivery>

#### More information

##### Note:

Do you need a specific modification or option for the products described here? Then look up "Customized products", where you will find information about the Open Platform Program for the creation of user-specific functions and controls for WinCC flexible.

**Overview**

- Targeted and rapid process diagnostics in plants and machines for SIMATIC S7 and SIMATIC HMI
- Standardized diagnostics concept for various SIMATIC components
- No further configuration overhead for diagnostics functionality
- Frees up PLC capacity with regard to memory and program execution time

Note:

For more information, see "Process Diagnostics Software SIMATIC ProAgent".

**More information**Note:

Do you need a specific modification or option for the products described here? Then look up "Customized products", where you will find information about the Open Platform Program for the creation of user-specific functions and controls for WinCC flexible.

**Ordering data****Article No.****WinCC flexible /ProAgent for SIMATIC Panels <sup>1)</sup>**

executable on Mobile Panel 277, TP/OP/MP 270/277 and MP 370/377

- single license, only license key on USB stick
  - download <sup>2)</sup>
- Single license, license key download only; E-mail address required for the delivery

**6AV6618-7DB01-3AB0****6AV6618-7DB01-3AH0****WinCC flexible /ProAgent for WinCC flexible Runtime 2008 <sup>1)</sup>**

- single license, only license key on USB stick
  - download <sup>2)</sup>
- Single license, license key download only; E-mail address required for the delivery

**6AV6618-7DD01-3AB0****6AV6618-7DD01-3AH0**

<sup>1)</sup> One license is required for each operator station. A license is not required for the engineering system for configuring the Runtime option.

<sup>2)</sup> Current information and availability regarding the new type of delivery can be found at: <http://www.siemens.com/tia-online-software-delivery>

## HMI Software

### SCADA system SIMATIC WinCC V7

#### Introduction

#### Overview



#### **SIMATIC WinCC V7 SCADA system**

The scalable and open SCADA system for maximum plant transparency and productivity

- **Efficiency:**  
As a key to greater productivity, SIMATIC WinCC combines efficient engineering with high-performance archiving and maximum data security. With integrated diagnostics functions and flexible production analysis, you shorten the time-to-market and also reduce your plant standstill times.  
SIMATIC WinCC is the basis for efficient operations management and intelligent production analyses, so it offers a secure basis for deciding on optimization measures, and thus more productivity at lower cost.
- **Scalability:**  
With SIMATIC WinCC, it is possible to implement plants in all industrial sectors and technologies, and easily expand or modernize them by means of options or add-ons, in functional terms or sector-specifically.  
You can benefit from the redundancy concepts for enhanced availability, or decide on centralized archiving and analysis of plant information. SIMATIC WinCC offers stationary and mobile solutions to cover increasing demands.

- **Innovation:**  
With innovative technology, you have all the important information in view at all times. In this way, SIMATIC WinCC simplifies intuitive operation and monitoring of the production plant – even remotely. Stay informed with mobile SCADA solutions anywhere and at any time – including with existing tablet and smartphone hardware.  
The use of multi-touch gestures in the industrial environment opens the door to modern operator concepts.
- **Openness:**  
Since international standards and system-internal script and programming interfaces are supported, special requests can also be easily implemented.  
SIMATIC WinCC backs cross-vendor communication for integrating existing hardware, as well as for simple integration into the IT world. WinCC Specialists are available worldwide as qualified solution providers. These certified and centrally audited partners are ready to implement your individual SCADA project even in diversified client-server architectures with redundancy, or in applications with energy data management systems.  
SIMATIC WinCC is designed to be independent of any specific technology or industrial sector, modular in structure, and easy to expand. It is used worldwide in single-user applications in mechanical engineering, as well as in complex multi-user solutions with redundant servers or Web-based client access. References from many industries prove the versatility and performance capability.

<http://www.siemens.com/wincc-v7>

**Overview**

- PC-based operator control and monitoring system for visualizing and operating processes, production flows, machines and plants in all sectors – from the simple single-user station through to distributed multi-user systems with redundant servers and cross-location solutions with web clients. WinCC is the information hub for corporation-wide vertical integration.
- The basic system configuration (WinCC basic software) includes industry-standard functions for signaling and acknowledging events, archiving of messages and measured values, logging of all process and configuration data, user administration and visualization.
- The WinCC basic software forms the core of a wide range of different applications. Based on the open programming interfaces, a wide range of WinCC options (from Siemens Industry Automation) and WinCC add-ons have been developed (by Siemens-internal and external partners).
- WinCC can be operated with every PC that meets the given HW requirements. The SIMATIC IPC product range is available in particular for the industrial use of WinCC systems. SIMATIC IPCs impress with their powerful PC technology, are designed for round-the-clock operation, and can be operated in both office areas and harsh industrial environments.

Current versions:

**SIMATIC WinCC V7.5**

Runs on:

- Windows 10 Professional, Enterprise (64-bit)
- Windows 10 Enterprise LTSC (64-bit)
- Windows 2012 Server R2 (64-bit)
- Windows 2016 Server (64-bit)

For WebNavigator Clients and DataMonitor Clients, also:

- Windows 7 SP1 Professional, Enterprise, Ultimate (32-/64-bit)
- Windows 8.1 Professional, Enterprise (32-/64-bit)

Please check the Siemens Online Support compatibility list for details:

<https://support.industry.siemens.com/kompatool/pages/main/index.jsf?>

**SIMATIC WinCC V7.4 SP1**

Runs on:

- Windows 7 Professional, Enterprise, Ultimate (32-/64-bit)
- Windows 8.1 Professional, Enterprise (32-/64-bit)
- Windows 10 Professional, Enterprise, 2015 LTSC, 2016 LTSC (64-bit)
- Windows 2008 Server R2 SP1 (64-bit)
- Windows 2012 Server R2 (64-bit)
- Windows 2016 Server (64-bit)
- Includes Microsoft SQL Server 2014 SP1 (32-bit)

Use in virtual environments – for more information see:

<http://support.automation.siemens.com/WW/view/en/49370459>

**SIMATIC SCADA and SIMATIC IPCs**

Perfect interaction for optimum productivity.

- Price advantage as "Package" comprising hardware and software
- System-tested solutions reduce testing overhead
- Simple ordering and synchronized logistics

Only if ordered together with the SIMATIC IPC.

## HMI Software

### SCADA system SIMATIC WinCC V7

#### SIMATIC WinCC V7

##### Benefits

- All-purpose
  - Solutions for all sectors
  - Multi-language for worldwide usage
  - Can be integrated into all automation solutions
- All operator control & monitoring functions on board
  - User administration
  - Operator control and monitoring
  - Reporting, acknowledging, and archiving of events
  - Collecting, consolidating and archiving measured values (including long-term backup)
  - Logging and documenting of process and configuration data
- Can be configured simply and efficiently
  - Configuration wizards let the user focus on the essentials
  - In the picture by means of cross-reference lists and screen property displays
  - Configuration of multi-language applications
  - Configuring tool for configuring bulk data
- Universally scalable
  - Expandable from single station to client-server configurations
  - Increased availability by means of redundant servers
  - Process visualization via the Web with the WinCC WebNavigator or WebUX
- Open standards for simple integration
  - Efficient real-time database MS SQL Server
  - Open for application modules with ActiveX controls
  - Visual Basic for Applications for individual expansions
  - OPC for cross-vendor communication
- Process visualization with Plant Intelligence
  - Integrated evaluation functions for the online analysis (statistical process control)
  - Production optimization with the help of diverse options
- Expandable using options and add-ons
  - Options for scalable configurations
  - Options for increasing the availability
  - Options for IT & business integration
  - Options for SCADA expansions
  - Options for validation in accordance with FDA 21 CFR Part 11
  - Options for the use of telecontrol protocols
- Part of Totally Integrated Automation
  - Direct access to the tag and message configuration of the SIMATIC control system
  - Integrated diagnostic functions for increasing productivity

##### New with V7.5

- Extended functionality for object-oriented configuration
  - Import and use of structured data types from S7-1500 PLCs and OPC UA data sources
  - Use of structure data types as an interface to the faceplates
- Extended functionality for the design of the runtime interface
  - Additional characteristics for dynamization of SVG graphics from the WinCC library including support for WebUX
  - Integration of the central color palette in the project design template including option for changeover during runtime
- Communication
  - OPC UA client enhanced for Alarm & Condition
  - Possible to configure access rights for WinCC tags via the WinCC OPC server
  - WinCC Cloud Connect for sending WinCC data to cloud systems using the MQTT protocol
- Graphics Designer
  - Easier configuration of multi-language texts and font settings for all text elements in graphics
  - New animation option for dynamization of object properties without script programming
- Other innovations
  - WinCC WebUX: Auto-Login for operate mode, enhanced features for trend control dynamization and central color palette for alarm configuration
  - Reworked tag simulator with new options for system tags for monitoring communication channel and login performance values
  - Structuring of WinCC images (PDLs) in subfolders possible
  - Menu and toolbars can be configured via new editor in Config Studio

##### Application

SIMATIC WinCC is designed for visualization and operation of processes, production flows, machines and plants. With its powerful process interface, especially to the SIMATIC family, and the secure data archiving, WinCC enables highly available solutions for the process control.

The sector-neutral basic system enables universal usage in all automation applications. Sector-specific solutions can, for example, be implemented using WinCC options (e.g. FDA options for the pharmaceutical industry) and sector-specific add-ons (e.g. for the water industry).

### Design

SIMATIC WinCC is available as a complete package and as a runtime package with 128, 512, 2 048, 8 192, 65 536, 102 400, 153 600, 262 144 PowerTags. PowerTags are data points that are connected to controllers or other data sources over a WinCC channel. Up to 32 alarms can be obtained from one data point. Moreover, internal tags without coupling are available for additional system performance. In addition WinCC also contains 512 archive tags. Additional archive licenses can be obtained for larger quantity structures.

#### Licenses for a multi-user configuration

The system software with the required number of PowerTags and additionally the option WinCC/Server must be installed on the WinCC server. In the basic configuration, one RT Client License is sufficient for the WinCC Clients <sup>1)</sup>. An RC Client License is required to configure on clients <sup>1)</sup>. Remote configuration is possible if WinCC Clients without their own project (Uni Client) are configured on the server project.

<sup>1)</sup> The SQL Server Express is installed for RT / RC Clients.

### Function

The powerful configuration functions of SIMATIC WinCC contribute to a reduced engineering and training overhead and lead to a more flexible use of personnel and greater operational reliability.

Anyone familiar with Microsoft Windows can also operate the WinCC Explorer, the central switching point of WinCC. Even large quantities of data can be processed intuitively and efficiently with the WinCC Configuration Studio.

In combination with other SIMATIC components, the system is also equipped with auxiliary functions, such as process diagnostics and maintenance. All SIMATIC engineering tools work together in the configuration of the functions.

SIMATIC WinCC offers a complete basic functionality for process visualization and operation. To this end WinCC has a number of editors and interfaces that can be used to individually configure this functionality according to the respective application. Expansions of a WinCC station for control tasks are also possible with minimal engineering effort.

WinCC editors	Task or configurable runtime functionality
WinCC Explorer	Central project management for the quick access to all project data and central settings
WinCC Graphics Designer	Graphics system for user-defined visualization and operation via pixel-graphic objects
WinCC Configuration Studio	<p><u>Alarm Logging</u></p> <p>Signaling system for detecting and archiving events with display and control options based on DIN 19235; freely selectable message classes, message display and logging</p> <p><u>WinCC Tag Logging</u></p> <p>Process archiving for the acquisition, compression and storage of measured values, e.g. presentation in trend and table format as well as further processing</p> <p><u>WinCC User Administrator</u></p> <p>For managing users and authorizations</p>
WinCC Report Designer	Reporting and logging system for time and event-controlled documentation of messages, operator inputs and current process data in the form of user reports or project documentation in an arbitrary layout
WinCC Global Script	Processing functions with limitless functionality by means of the use of VB Script and ANSI-C

Interfaces	Task or configurable runtime functionality
Communication channels	Communication with lower-level controls (SIMATIC protocols, PROFIBUS DP and OPC server included in scope of supply)
Standard interfaces	Facilitate the open integration of other Windows applications via WinCC, WinCC-OLE-DB, ActiveX, OLE, OPC etc.
Programming interfaces	For the individual access to data and functions of WinCC and for the integration in user programs with VBA, VB Script, C-API (ODK), C-Script (ANSI-C)

## HMI Software

### SCADA system SIMATIC WinCC V7

#### SIMATIC WinCC V7

#### Integration

##### **Integration in company-wide solutions (IT and business integration)**

WinCC is based on Microsoft technology, which ensures openness and integration capability. ActiveX and .net controls facilitate technology-specific and industry-specific expansions. Cross-manufacturer communication is also possible since WinCC can be used as an OPC client and server in addition to accessing current process values and supporting standards such as OPC HDA (Historical Data Access), OPC Alarm & Events, OPC XML Data Access, and OPC UA.

Just as important: Visual Basic for Applications (VBA) is available for user-specific expansions in engineering, and Visual Basic Scripting (VBS) as an easy-to-learn, open, runtime language. If desired, professional application developers can also use ANSI-C. The Open Development Kit (ODK) simplifies access to the API programming interfaces.

WinCC integrates a powerful and scalable archiving feature using database technology. This provides the user with a variety of options: from high-performance archiving of current process data, to long-term archiving with high data compression, through to a connection to the central information hub in the form of a company-wide Process Historian. Versatile clients and tools for evaluation, the open interfaces, and special options (Connectivity Pack, Connectivity Station, IndustrialDataBridge) provide the basis for effective IT and business integration.

WinCC offers various security mechanisms, such as encrypted communication, to ensure secure operation of the plant. If external networks are accessed, for example, suitable protective measures (incl. IT security measures, such as network segmentation) should still also be taken.

You can find more information on the topic of Industrial Security on the Internet at:

<http://www.siemens.com/industrialsecurity>

##### **Integration in automation solutions**

WinCC is an open process visualization system and provides the option to connect the most diverse control systems.

##### **Approved communication software**

Use communication software with the listed product versions. Corresponding SIMATIC NET upgrades are available for upgrading older versions.

##### **Number of connectable controllers**

For the number of controllers which can be connected via Industrial Ethernet CP 1613, the following applies to a message frame length of 512 bytes:

Type of connection	Number of nodes
SIMATIC S5 Ethernet Layer 4 + TCP/IP	Up to 60
SIMATIC S7 Protocol Suite	Up to 64
SIMATIC 505 Ethernet Layer 4 + TCP/IP	Up to 60
SIMATIC S7-1200/1500 Channel	Up to 128

Via PROFIBUS, a maximum of 8 controllers can be connected with CP 5612, and a maximum of 44 controllers with CP 5613. Industrial Ethernet is recommended when 10 or more controllers are used.

##### **Mixed operation with different controllers**

With their multi-protocol stack, the CP 1613 and CP 5613 communication processors enable the parallel operation of two protocols, such as for the mixed operation of different controllers, via a single bus cable. WinCC supports the operation of two similar interface boards only in connection with the channels SIMATIC S5 Ethernet Layer 4 (2 x CP 1613), SIMATIC S7 Protocol Suite (2 x CP 1613, 2 x CP 5613) as well as PROFIBUS DP (4 x CP 5613; max. 122 slaves for each CP 5613). In addition to communication via Industrial Ethernet CP 1613 or PROFIBUS CP 5613, one CP 5612/5622 can be used in each case for communication with SIMATIC S7 via MPI.

##### **Client-server communication**

Communication between the clients and the server is via TCP/IP protocol. Setting up a separate PC LAN is recommended. For small projects with a correspondingly low incidence of message frames, SIMATIC NET Industrial Ethernet communication can be used for both process communication (WinCC/server « PLC) and PC-PC communication (WinCC/client « WinCC/server).

##### **Channel DLL PROFIBUS DP**

In accordance with the PROFIBUS standard, DP/slaves are always permanently assigned to a DP master; i.e. a second WinCC station (DP/master) cannot access the same controllers (DP/slaves). This means that redundant operation of two WinCC stations is not possible using the PROFIBUS DP connection.



**Integration** (continued)**Connection to controllers from other manufacturers:**

If a native driver is not available, OPC or OPC UA is available for connection to third-party controllers.

Current notes and information about OPC servers from various suppliers can be found at:

<http://www.opcfoundation.org>

WinCC supports the standards:

- OPC Data Access 2.05a
- OPC Data Access 3.00
- OPC UA 1.02
- OPC UA HA 1.20
- OPC UA Alarms and Conditions 1.20
- OPC Historical Alarms and Events 1.10
- OPC XML Data Access 1.01 (Connectivity Pack/ Connectivity Station)
- OPC HDA 1.20 (Connectivity Pack/Connectivity Station)
- OPC A&E 1.10 (Connectivity Pack/Connectivity Station)
- OPC UA Client Data Access
- OPC UA Server Data Access, HDA, Alarm & Condition (Connectivity Pack/Connectivity Station)

**Connection overview**

Protocol	Description
<b>SIMATIC S7</b>	
SIMATIC S7 Protocol Suite	Channel DLL for S7 functions via MPI, PROFIBUS or Ethernet Layer 4 + TCP/IP
<b>SIMATIC S5</b>	
SIMATIC S5 Ethernet Layer 4	Channel DLL for S5 Layer 4 communication + TCP/IP
SIMATIC S5 Programmer Port AS511	Channel DLL and driver for serial communication with S5 using AS511 protocol to programmers port
SIMATIC S5 Serial 3964R	Channel DLL and driver for serial communication with S5 using RK512 protocol
SIMATIC S5 PROFIBUS-FDL	Channel DLL for S5-FDL
<b>SIMATIC 505</b>	
SIMATIC 505 Serial	Channel DLL and driver for serial communication with 505 using NITP/TBP protocol to SIMATIC 535/545/555/565/575
SIMATIC 505 Ethernet Layer 4	Channel DLL for 505 Layer 4 communication
SIMATIC 505 TCP/IP	Channel DLL for 505 TCP/IP communication
<b>SIMATIC S7-1200, S7-1500</b>	
SIMATIC S7-1200, S7-1500 Channel	Channel DLL for S7-1200 and S7-1500 communication
<b>Third-party controllers</b>	
Allen Bradley Ethernet IP	Channel DLL and drivers for communication with Allen Bradley controllers via Ethernet TCP/IP using Ethernet IP protocol
Modbus TCP/IP	Channel DLL and drivers for communication with Modicon controllers via Ethernet TCP/IP using Modbus TCP/IP protocol
Mitsubishi MC TCP/IP	Channel DLL and drivers for communication with Mitsubishi controllers via Ethernet TCP/IP using Mitsubishi MC TCP/IP protocol

Protocol	Description
<b>Cross-manufacturer</b>	
OPC client for DA, XML DA	Channel DLL for OPC communication; WinCC can acquire data from OPC server applications
OPC server for DA, XML DA, A&C	Channel DLL for OPC communication; WinCC can acquire data from OPC server applications
OPC server for DA, XML DA, A&E, HDA	Server applications for OPC communication; WinCC provides process data to OPC clients
OPC UA server for DA, HDA, A&C	Server applications for OPC UA communication
PROFIBUS DP	Channel DLL for PROFIBUS DP
SIMOTION	Channel DLL for SIMOTION

**Application note:**

Parallel usage of the OPC client channel allows, for example, connection to an SNMP OPC server for visualization of the data contained there.

The SNMP OPC server enables monitoring of any network components (such as switches) that support the SNMP protocol. You can find more information under SIMATIC NET Communications Systems/SNMP OPC Server.

## HMI Software

### SCADA system SIMATIC WinCC V7

#### SIMATIC WinCC V7

#### Integration (continued)

##### PG/PC communication components for SIMATIC (for WinCC V7.5)

Industrial Ethernet	SIMATIC S5 Ethernet Layer 4	SIMATIC S5 TCP/IP	SIMATIC S7 Protocol Suite	SIMATIC 505 Ethernet Layer 4	SIMATIC 505 TCP/IP <sup>1)</sup>	Article No.
<b>WinCC – channel DLL</b>						
<b>SIMATIC S5 Ethernet Layer 4</b> Channel DLL for S5 Layer 4 communication + TCP/IP	•	•				Included in the basic package
<b>SIMATIC S7 Protocol Suite</b> Channel DLL for S7 functions			•			Included in the basic package
<b>SIMATIC 505 Ethernet Layer 4</b> Channel DLL for 505 Layer 4 communication				•		Included in the basic package
<b>SIMATIC 505 TCP/IP <sup>1)</sup></b> Channel DLL for 505 TCP/IP communication					•	Included in the basic package
<b>Communication components for extension of the OS/OP</b>						
<b>CP 1612 A2</b> PCI card for connecting a PG/PC to Industrial Ethernet (SOFTNET-S7 or SOFTNET-S7 Lean communication software must be ordered separately)		•	•		•	<b>6GK1161-2AA01</b>
<b>SOFTNET-IE S7</b> Communication software for S7 functions (max. 64 connections) Version 15 <sup>2)3)</sup>		•	•			<b>6GK1704-1CW15-0AA0</b>
<b>SOFTNET-IE S7 Lean</b> Communication software for S7 functions (max. 8 connections) Version 15 <sup>2)3)</sup>		•	•			<b>6GK1704-1LW15-0AA0</b>
<b>CP 1623</b> PCI Express X1 card (32-bit) for connecting a PG/PC to Industrial Ethernet (S7-1613 communication software required)	•	•	•	•	•	<b>6GK1162-3AA00</b>
<b>CP 1628</b> PCI Express X1 card (32-bit) for connecting a PG/PC to Industrial Ethernet (HARDNET-IE S7 / S7-1613 communication software req.)	•	•	•	•	•	<b>6GK1162-8AA00</b>
<b>HARDNET-IE S7 / S7-1613</b> Communication software for S7 functions, OPC, PG/OP communication Version 15 <sup>2)3)</sup>	•	•	•	•		<b>6GK1716-1CB15-0AA0</b>

• System interface possible

<sup>1)</sup> Via any interface board with NDIS 3.0 interface; no separate communication software required

<sup>2)</sup> See ordering data for SIMATIC NET upgrade packages

<sup>3)</sup> SIMATIC NET version V15 is supplied together with WinCC V7.5

<sup>4)</sup> SOFTNET-S7 Lean included in scope of supply of WinCC V7.5

##### Communications components for PG/PC for SIMATIC (for WinCC V7.4 SP1)

Industrial Ethernet	SIMATIC S5 Ethernet Layer 4	SIMATIC S5 TCP/IP	SIMATIC S7 Protocol Suite	SIMATIC 505 Ethernet Layer 4	SIMATIC 505 TCP/IP <sup>1)</sup>	Article No.
<b>WinCC – channel DLL</b>						
<b>SIMATIC S5 Ethernet Layer 4</b> Channel DLL for S5 Layer 4 communication + TCP/IP	•	•				Included in the basic package
<b>SIMATIC S7 Protocol Suite</b> Channel DLL for S7 functions			•			Included in the basic package
<b>SIMATIC 505 Ethernet Layer 4</b> Channel DLL for 505 Layer 4 communication				•		Included in the basic package
<b>SIMATIC 505 TCP/IP <sup>1)</sup></b> Channel DLL for 505 TCP/IP communication					•	Included in the basic package

**Integration** (continued)

<b>Industrial Ethernet</b>	<b>SIMATIC S5 Ethernet Layer 4</b>	<b>SIMATIC S5 TCP/IP</b>	<b>SIMATIC S7 Protocol Suite</b>	<b>SIMATIC 505 Ethernet Layer 4</b>	<b>SIMATIC 505 TCP/IP <sup>1)</sup></b>	<b>Article No.</b>
<b>Communication components for extension of the OS/OP</b>						
<b>CP 1612 A2</b> PCI card for connecting a PG/PC to Industrial Ethernet (SOFTNET-S7 or SOFTNET-S7 Lean communication software must be ordered separately)		•	•		•	<b>6GK1161-2AA01</b>
<b>SOFTNET-IE S7</b> Communication software for S7 functions (max. 64 connections) • Version 14 SP1 <sup>2)3)</sup> For Windows 7 SP1 Prof./Ult. (32/64-bit) Windows 8.1 PRO (64-bit) Windows 10 Server 2008 R2 SP1 Server 2012 R2 (64-bit)		•	•			<b>6GK1704-1CW14-0AA0</b>
<b>SOFTNET-IE S7 Lean</b> Communication software for S7 functions (max. 8 connections) • Version 14 SP1 <sup>2)3)</sup> For Windows 7 SP1 Prof./Ult. (32/64-bit) Windows 8.1 PRO (64-bit) Windows 10 Server 2008 R2 SP1 Server 2012 R2 (64-bit)		•	•			<b>6GK1704-1LW14-0AA0</b>
<b>CP 1623</b> PCI Express X1 card (32-bit) for connecting a PG/PC to Industrial Ethernet (S7-1613 communication software required)	•	•	•	•	•	<b>6GK1162-3AA00</b>
<b>CP 1628</b> PCI Express X1 card (32-bit) for connecting a PG/PC to Industrial Ethernet (HARDNET-IE S7 / S7-1613 communication software required)	•	•	•	•	•	<b>6GK1162-8AA00</b>
<b>HARDNET-IE S7 / S7-1613</b> communication software for S7 functions, OPC, PG/OP communication • Version 13 SP2 <sup>2)3)</sup> for Windows 7 SP1 (32/64-bit), Windows 8.1 (32/64-bit), Windows 2008 R2 SP1 Server, Server 2012 R2 (64-bit), and Windows 10 (64-bit)	•	•	•	•		<b>6GK1716-1CB13-0AA0</b>

- System interface possible

<sup>1)</sup> Via any interface board with NDIS 3.0 interface; no separate communication software required  
<sup>2)</sup> See ordering data for SIMATIC NET upgrade packages  
<sup>3)</sup> SIMATIC NET Version V12 SP2 is supplied together with WinCC V7.4 SP1  
<sup>4)</sup> SOFTNET-S7 Lean included in scope of supply of WinCC V7.4 SP1

**HMI Software**

## SCADA system SIMATIC WinCC V7

**SIMATIC WinCC V7****Integration** (continued)**PG/PC communication components for SIMATIC  
(for WinCC V7.5)**

PROFIBUS	SIMATIC S5 PROFIBUS FDL	SIMATIC S7 Protocol Suite	PROFIBUS DP	PROFIBUS FMS	Article No.
<b>WinCC – channel DLL</b>					
<b>SIMATIC S5 PROFIBUS FDL</b> Channel DLL for S5-FDL	•				Included in the basic package
<b>SIMATIC S7 Protocol Suite</b> Channel DLL for S7 functions		•			Included in the basic package
<b>PROFIBUS DP</b> Channel DLL for PROFIBUS DP			•		Included in the basic package
<b>Communication components for extension of the OS/OP</b>					
<b>CP 5612</b> <sup>2)</sup> PCI card (32-bit) for connecting a PG/PC to PROFIBUS (communication software included in WinCC basic package)		•			<b>6GK1561-2AA00</b>
<b>CP 5622</b> <sup>2)</sup> PCI Express X1 card (32-bit) for connecting a PG/PC to PROFIBUS (communication software included in WinCC basic package)		•			<b>6GK1562-2AA00</b>
<b>CP 5711</b> USB adapter for connecting a PG/PC to PROFIBUS or MPI (communication software included in WinCC basic package)		•			<b>6GK1571-1AA00</b>
<b>CP 5613 A3</b> PCI card (32-bit) for connecting a PC to PROFIBUS (S7-5613, DP-5613 or FMS-5613 communication software required)	•	•	•	•	<b>6GK1561-3AA02</b>
<b>CP 5614 A3</b> PCI card (32-bit) for connecting a PC to PROFIBUS (communication software must be ordered separately)	•	•	•	•	<b>6GK1561-4AA02</b>
<b>CP 5623</b> PCI Express X1 card (32-bit) for connecting a PG/PC to PROFIBUS or MPI ( <b>HARDNET PB S7</b> or <b>HARDNET PB DP</b> communication software required)	•	•	•	•	<b>6GK1562-3AA00</b>
<b>HARDNET PB S7</b> Communication software for S7 functions + FDL	•	•			<b>6GK1713-5CB15-0AA0</b>
<b>HARDNET PB DP</b> Communication software for DP master + FDL	•		•		<b>6GK1713-5DB15-0AA0</b>

- System interface possible

1) See ordering data for SIMATIC NET upgrade package

2) SIMATIC NET Version 8.2 SP1 is supplied together with WinCC V7.4 SP1

**Integration** (continued)**Communication components for PG/PC for SIMATIC  
(for WinCC V7.4 SP1)**

PROFIBUS	SIMATIC S5 PROFIBUS FDL	SIMATIC S7 Protocol Suite	PROFIBUS DP	PROFIBUS FMS	Article No.
<b>WinCC – channel DLL</b>					
<b>SIMATIC S5 PROFIBUS FDL</b> Channel DLL for S5-FDL	•				Included in the basic package
<b>SIMATIC S7 Protocol Suite</b> Channel DLL for S7 functions		•			Included in the basic package
<b>PROFIBUS DP</b> Channel DLL for PROFIBUS DP			•		Included in the basic package
<b>Communication components for extension of the OS/OP</b>					
<b>CP 5612</b> <sup>2)</sup> PCI card (32-bit) for connecting a PG/PC to PROFIBUS (communication software included in WinCC basic package)		•			<b>6GK1561-2AA00</b>
<b>CP 5622</b> <sup>2)</sup> PCI Express X1 card (32-bit) for connecting a PG/PC to PROFIBUS (communication software included in WinCC basic package)		•			<b>6GK1562-2AA00</b>
<b>CP 5711</b> USB adapter for connecting a PG/PC to PROFIBUS or MPI (communication software included in WinCC basic package)		•			<b>6GK1571-1AA00</b>
<b>CP 5613 A3</b> PCI card (32-bit) for connecting a PC to PROFIBUS (S7-5613, DP-5613 or FMS-5613 communication software required)	•	•	•	•	<b>6GK1561-3AA02</b>
<b>CP 5614 A3</b> PCI card (32-bit) for connecting a PC to PROFIBUS (communication software must be ordered separately)	•	•	•	•	<b>6GK1561-4AA02</b>
<b>CP 5623</b> PCI Express X1 card (32-bit) for connecting a PG/PC to PROFIBUS or MPI ( <b>HARDNET PB S7</b> or <b>HARDNET PB DP</b> communication software required)	•	•	•	•	<b>6GK1562-3AA00</b>
<b>HARDNET PB S7</b> Communication software for S7 functions + FDL • Version 8.2 SP1 <sup>1)2)</sup> For Windows 7 (32/64-bit) and Server 2008 R2 (64-bit)	•	•			<b>6GK1713-5CB08-2AA0</b>
<b>HARDNET PB DP</b> Communication software for DP master + FDL • Version 8.2. SP1 <sup>1)2)</sup> For Windows 7 (32/64-bit) and Server 2008 R2 (64-bit)	•		•		<b>6GK1713-5DB08-2AA0</b>

- System interface possible

<sup>1)</sup> See ordering data for SIMATIC NET upgrade package

<sup>2)</sup> SIMATIC NET Version 8.2 SP1 is supplied together with WinCC V7.4 SP1

# HMI Software

## SCADA system SIMATIC WinCC V7

### SIMATIC WinCC V7

#### Integration (continued)

#### Communication examples

3

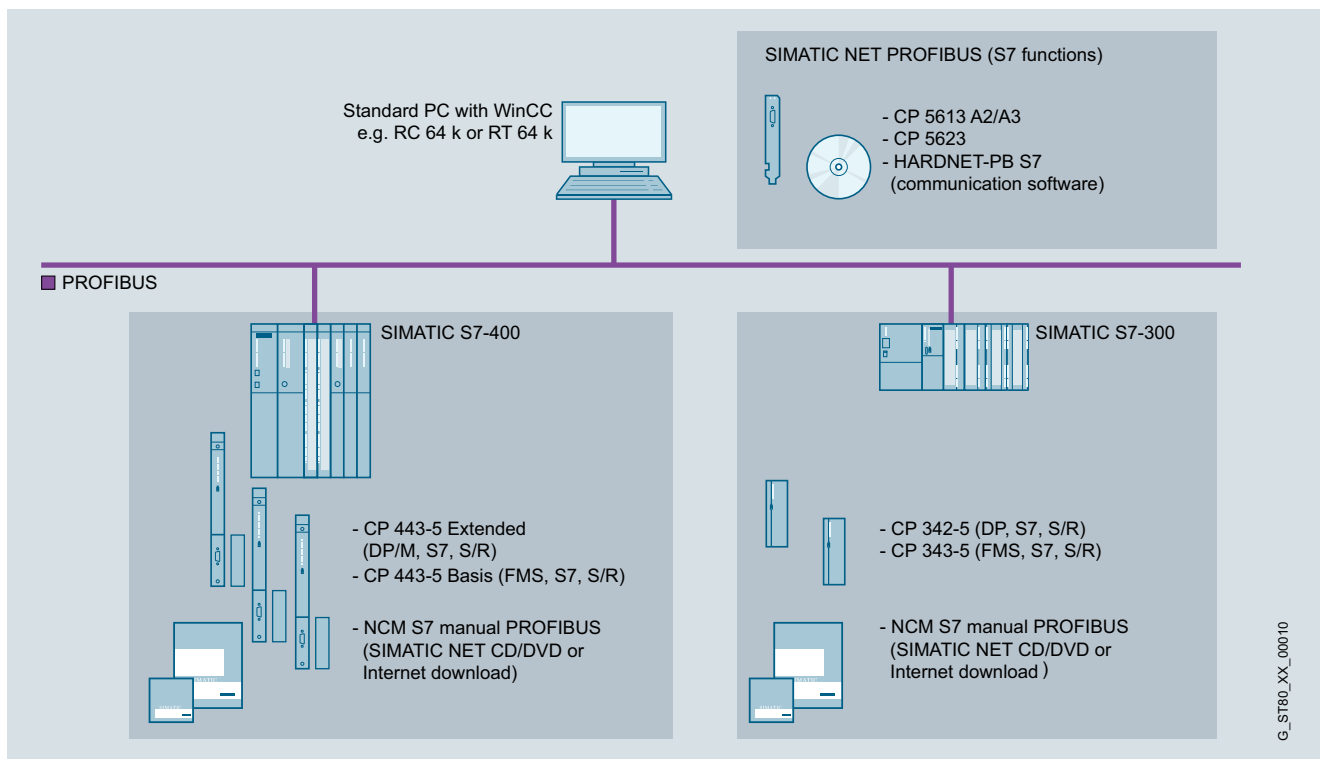

WinCC single-user system: PROFIBUS with S7 communication

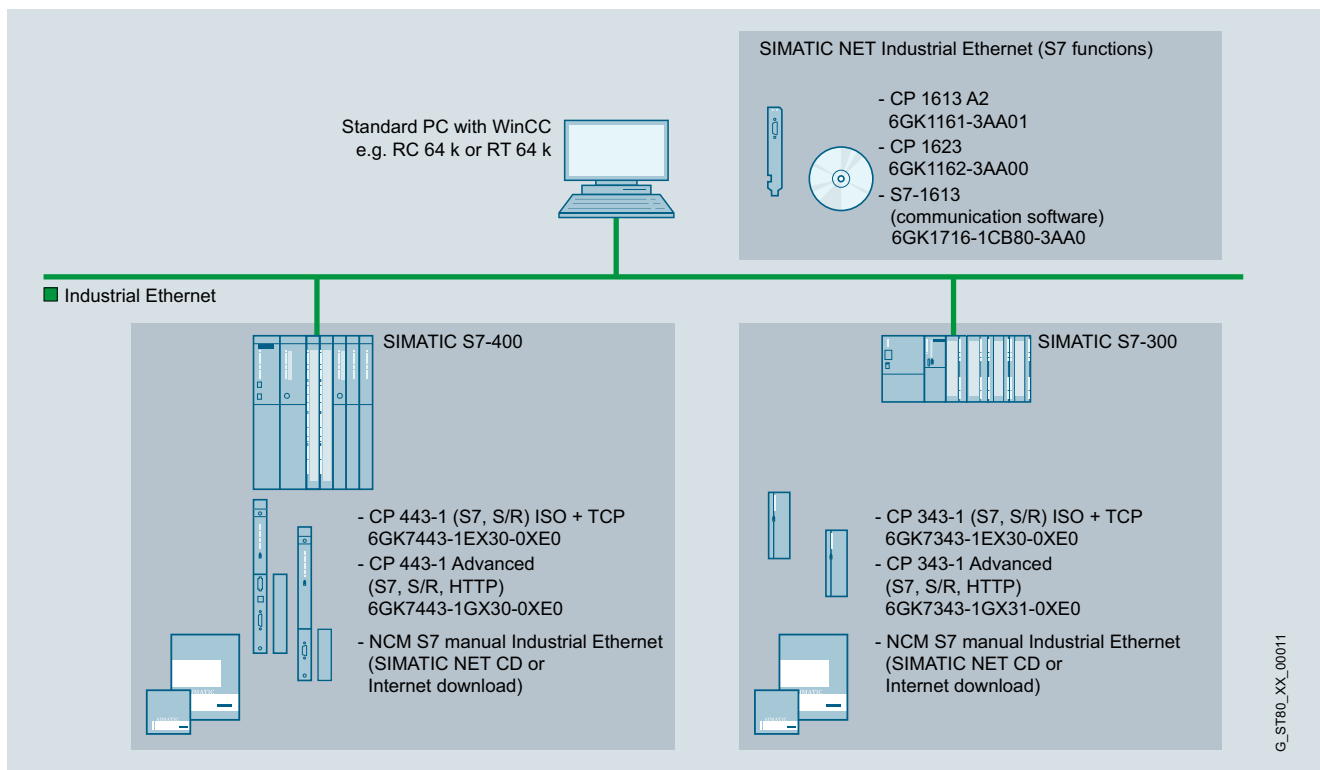

WinCC single-user system: Industrial Ethernet with S7 communication

Integration (continued)

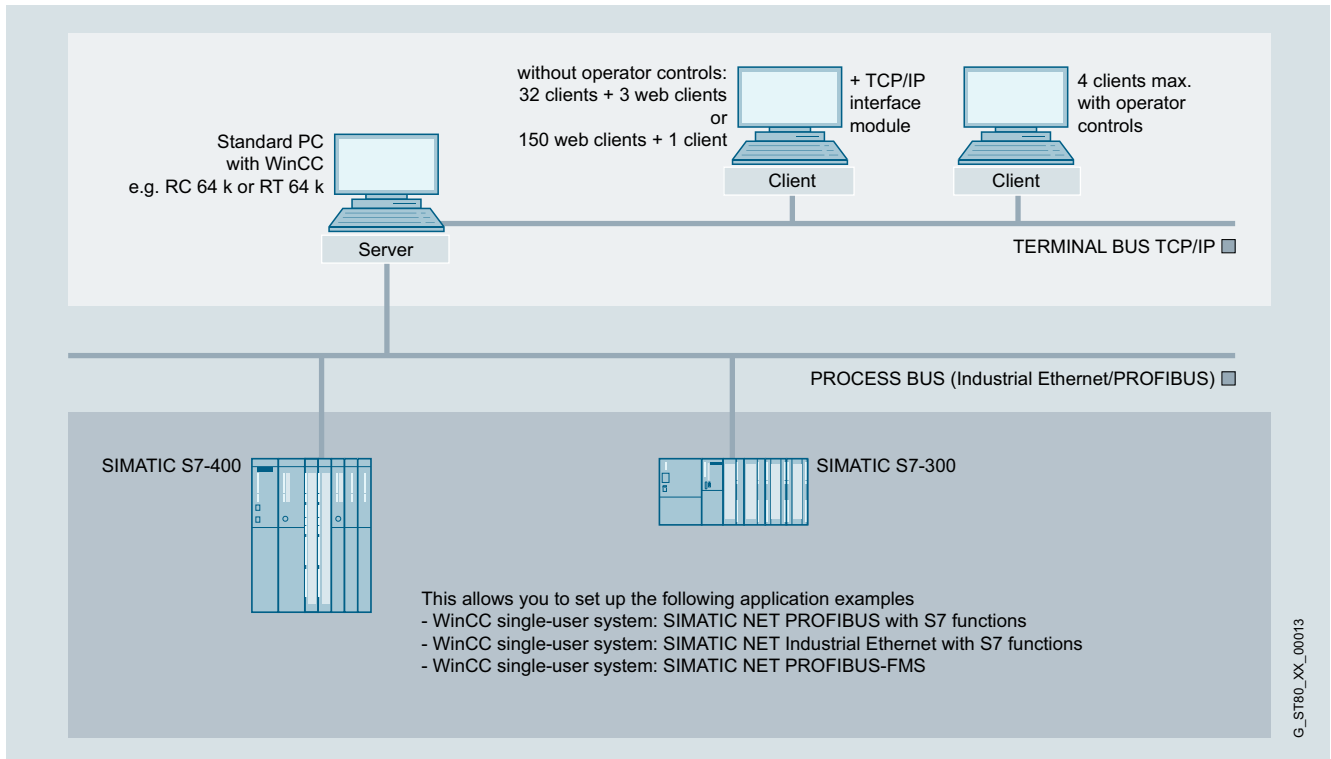

WinCC: Multi-user system with operable server

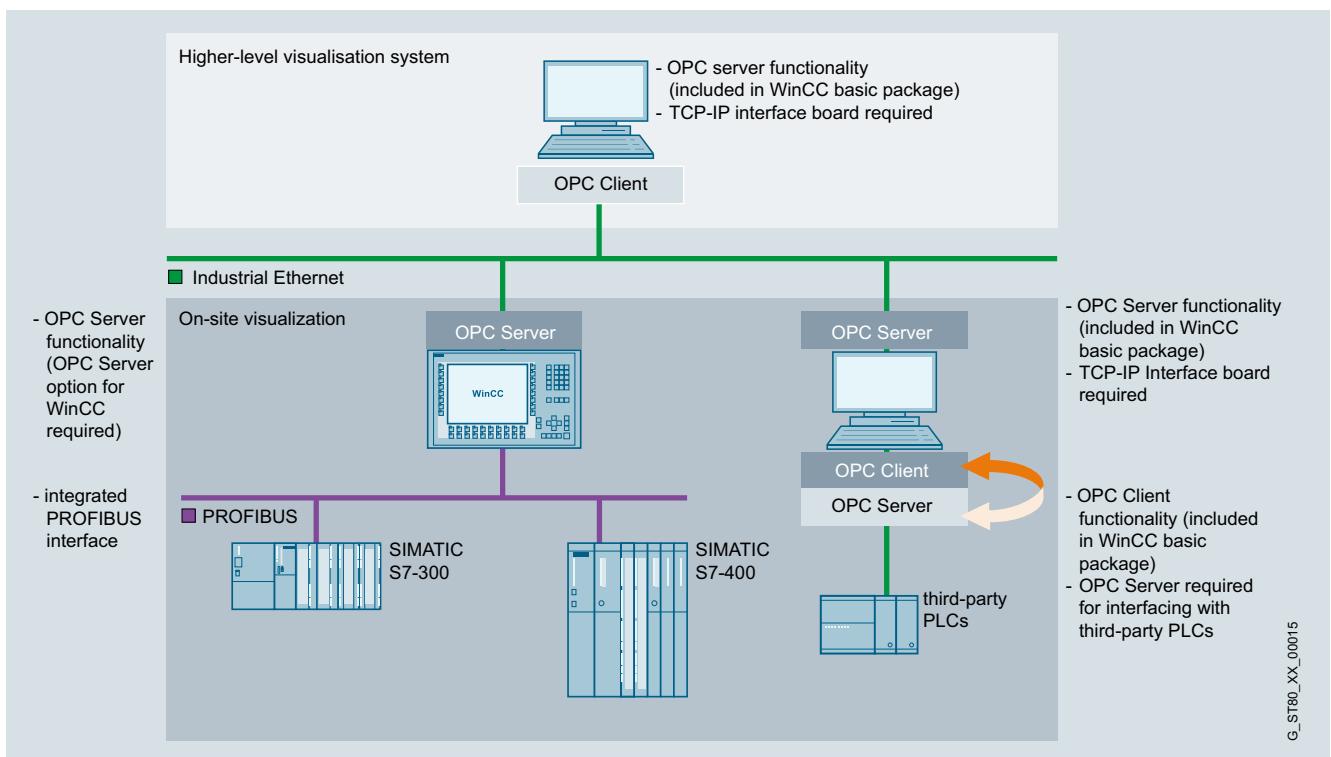

OPC link

3

**HMI Software**

## SCADA system SIMATIC WinCC V7

## SIMATIC WinCC V7

**Technical specifications**

Type	SIMATIC WinCC V7.5
<b>PC hardware requirements</b>	
<b>Processor type</b>	
• Minimum	Single-user station/server: Dual-core; 2.5 GHz
• Recommended	Client: Dual-core; 2.5 GHz Single-user station/server: Multi-core; 3.5 GHz Client: Multi-core; 3 GHz <sup>2)</sup>
<b>Work memory RAM</b>	
• Minimum	Windows 10 (64-bit) • Single-user station/server: 4 GB • Client: 2 GB
• Recommended	Windows Server 2012 R2/ Windows Server 2016 Server: 4 GB Windows 10 (64-bit) • Single-user station/server: 4 GB • Client: 4 GB Windows Server 2012 R2/ Windows Server 2016 Server: 8 GB
<b>Graphics resolution</b>	
• Minimum	800 x 600
• Recommended	1 920 x 1 080
<b>Hard disk</b>	
• Minimum	Single-user station/server: 80 GB Client: 20 GB
• Recommended	WebClient/DataMonitor Client: 5 GB Single-user station/server: 160 GB Client: 40 GB WebClient/DataMonitor Client: 10 GB
<b>DVD-ROM/USB interface</b>	
	For software installation and license transfer

Type	SIMATIC WinCC V7.5
<b>Functionality/quantity structure</b>	
Number of messages	150 000
• Message text (number of characters)	10 x 256
• Message archive	System-limited <sup>1)</sup>
• Process values per message	10
• Constant load of messages, max.	Server/single-user station: 10/s
• Message burst, max.	Server/single-user station: 2 000/10 s every 5 min
<b>Archive</b>	
• Archive data points	Max. 80 000 per server <sup>2)</sup>
• Archive types	Short-term archive with and without long-term archiving Microsoft SQL Server 2016 SP2
• Data storage format	Server/single-user station: up to 30 000/s <sup>4)</sup>
• Measured values per second	
<b>User archive</b>	
• Total archives	No limit
• Fields per user archive	500 (maximum number of 1 000 000 fields)
• Data records per user archive	10 000
• User archive views	No limit
<b>Graphics system</b>	
• Number of screens	System-limited <sup>1)</sup>
• Number of objects per screen	System-limited <sup>1)</sup>
• Number of controllable fields per screen	System-limited <sup>1)</sup>
<b>PowerTags</b>	
	256 K <sup>3)</sup>
<b>Trends</b>	
• Trend views per image	25
• Trends per trend view	80
<b>User administration</b>	
• User groups	128
• Number of users	128
• Authorization groups	999
<b>Configuration languages</b>	
	5 European (en, de, fr, it, es), 4 Asian (zh-CN, zh-TW, ko, ja)
<b>Protocols</b>	
• Message sequence reports (simultaneously)	1 per server/single-user station
• Message archive reports (simultaneously)	3
• User reports	System-limited <sup>1)</sup>
• Report lines per group	66
• Tags per report	300 <sup>5)</sup>
<b>Multi-user system</b>	
• Server	18
• Uni Client (without its own project)	Max. 64
• Multi-Client (with its own project)	Max. 50

<sup>1)</sup> Dependent on available storage space<sup>2)</sup> Dependent on number of licensed archive tags (ArchiveTags)<sup>3)</sup> Dependent on the number of licensed PowerTags<sup>4)</sup> Dependent on system performance, especially of hard disk (SSD/RAID recommended)<sup>5)</sup> Number of variables per report depends on process communication performance



Ordering data	Article No.	Article No.
<b>SIMATIC WinCC system software</b>		
<b>V7.5</b>		
<b>Runtime packages on DVD</b> Incl. 512 archive tags each; language/script versions: en, de, fr, it, es; with license for		
<ul style="list-style-type: none"> <li>WinCC RT Client</li> <li>128 PowerTags (RT 128)</li> <li>512 PowerTags (RT 512)</li> <li>2 048 PowerTags (RT 2 048)</li> <li>8 192 PowerTags (RT 8 192)</li> <li>65 536 PowerTags (RT 65 536)</li> <li>102 400 PowerTags (RT 102 400)</li> <li>153 600 PowerTags (RT 153 600)</li> <li>262 144 PowerTags (RT 262 144)</li> </ul>	<b>6AV6381-2CA07-5AX0</b> <b>6AV6381-2BC07-5AX0</b> <b>6AV6381-2BD07-5AX0</b> <b>6AV6381-2BE07-5AX0</b> <b>6AV6381-2BH07-5AX0</b> <b>6AV6381-2BF07-5AX0</b> <b>6AV6381-2BJ07-5AX0</b> <b>6AV6381-2BK07-5AX0</b> <b>6AV6381-2BL07-5AX0</b>	
<b>As download</b>		
<ul style="list-style-type: none"> <li>WinCC RT Client</li> <li>128 PowerTags (RT 128)</li> <li>512 PowerTags (RT 512)</li> <li>2 048 PowerTags (RT 2 048)</li> <li>8 192 PowerTags (RT 8 192)</li> <li>65 536 PowerTags (RT 65 536)</li> <li>102 400 PowerTags (RT 102 400)</li> <li>153 600 PowerTags (RT 153 600)</li> <li>262 144 PowerTags (RT 262 144)</li> </ul>	<b>6AV6381-2CA07-5AH0</b> <b>6AV6381-2BC07-5AH0</b> <b>6AV6381-2BD07-5AH0</b> <b>6AV6381-2BE07-5AH0</b> <b>6AV6381-2BH07-5AH0</b> <b>6AV6381-2BF07-5AH0</b> <b>6AV6381-2BJ07-5AH0</b> <b>6AV6381-2BK07-5AH0</b> <b>6AV6381-2BL07-5AH0</b>	
<b>Complete packages on DVD</b> Language versions: en, de, fr, it, es; with license for		
<ul style="list-style-type: none"> <li>WinCC RC Client</li> <li>128 PowerTags (RC 128)</li> <li>512 PowerTags (RC 512)</li> <li>2 048 PowerTags (RC 2 048)</li> <li>8 192 PowerTags (RC 8 192)</li> <li>65 536 PowerTags (RC 65 536)</li> <li>102 400 PowerTags (RC 102 400)</li> <li>153 600 PowerTags (RC 153 600)</li> <li>262 144 PowerTags (RC 262 144)</li> </ul>	<b>6AV6381-2CB07-5AX0</b> <b>6AV6381-2BM07-5AX0</b> <b>6AV6381-2BN07-5AX0</b> <b>6AV6381-2BP07-5AX0</b> <b>6AV6381-2BS07-5AX0</b> <b>6AV6381-2BQ07-5AX0</b> <b>6AV6381-2BT07-5AX0</b> <b>6AV6381-2BU07-5AX0</b> <b>6AV6381-2BV07-5AX0</b>	
<b>As download</b>		
<ul style="list-style-type: none"> <li>WinCC RC Client</li> <li>128 PowerTags (RC 128)</li> <li>512 PowerTags (RC 512)</li> <li>2 048 PowerTags (RC 2 048)</li> <li>8 192 PowerTags (RC 8 192)</li> <li>65 536 PowerTags (RC 65 536)</li> <li>102 400 PowerTags (RC 102 400)</li> <li>153 600 PowerTags (RC 153 600)</li> <li>262 144 PowerTags (RC 262 144)</li> </ul>	<b>6AV6381-2CB07-5AH0</b> <b>6AV6381-2BM07-5AH0</b> <b>6AV6381-2BN07-5AH0</b> <b>6AV6381-2BP07-5AH0</b> <b>6AV6381-2BS07-5AH0</b> <b>6AV6381-2BQ07-5AH0</b> <b>6AV6381-2BT07-5AH0</b> <b>6AV6381-2BU07-5AH0</b> <b>6AV6381-2BV07-5AH0</b>	
<b>V7.5 ASIA</b>		
<b>Runtime packages on DVD</b> Language/script versions: en, zh-CN, zh-TW, ko, ja; with license for		
<ul style="list-style-type: none"> <li>WinCC RT Client</li> <li>128 PowerTags (RT 128)</li> <li>512 PowerTags (RT 512)</li> <li>2 048 PowerTags (RT 2 048)</li> <li>8 192 PowerTags (RT 8 192)</li> <li>65 536 PowerTags (RT 65 536)</li> <li>102 400 PowerTags (RT 102 400)</li> <li>153 600 PowerTags (RT 153 600)</li> <li>262 144 PowerTags (RT 262 144)</li> </ul>		<b>6AV6381-2CA07-5AV0</b> <b>6AV6381-2BC07-5AV0</b> <b>6AV6381-2BD07-5AV0</b> <b>6AV6381-2BE07-5AV0</b> <b>6AV6381-2BH07-5AV0</b> <b>6AV6381-2BF07-5AV0</b> <b>6AV6381-2BJ07-5AV0</b> <b>6AV6381-2BK07-5AV0</b> <b>6AV6381-2BL07-5AV0</b>
<b>Complete packages on DVD</b> Language versions: en, zh-CN, zh-TW, ko, ja; with license for		
<ul style="list-style-type: none"> <li>WinCC RC Client</li> <li>128 PowerTags (RC 128)</li> <li>512 PowerTags (RC 512)</li> <li>2 048 PowerTags (RC 2 048)</li> <li>8 192 PowerTags (RC 8 192)</li> <li>65 536 PowerTags (RC 65 536)</li> <li>102 400 PowerTags (RC 102 400)</li> <li>153 600 PowerTags (RC 153 600)</li> <li>262 144 PowerTags (RC 262 144)</li> </ul>		<b>6AV6381-2CB07-5AV0</b> <b>6AV6381-2BM07-5AV0</b> <b>6AV6381-2BN07-5AV0</b> <b>6AV6381-2BP07-5AV0</b> <b>6AV6381-2BS07-5AV0</b> <b>6AV6381-2BQ07-5AV0</b> <b>6AV6381-2BT07-5AV0</b> <b>6AV6381-2BU07-5AV0</b> <b>6AV6381-2BV07-5AV0</b>
<b>V7.5 Powerpacks</b>		
<b>For upgrading from:</b>		
<b>Runtime packages</b>		
<ul style="list-style-type: none"> <li>128 to 512 PowerTags</li> <li>512 to 2 048 PowerTags</li> <li>2 048 to 8 192 PowerTags</li> <li>8 192 to 65 536 PowerTags</li> <li>65 536 to 102 400 PowerTags</li> <li>102 400 to 153 600 PowerTags</li> <li>153 600 to 262 144 PowerTags</li> </ul>		<b>6AV6371-2BD07-5AJ0</b> <b>6AV6371-2BG07-5AJ0</b> <b>6AV6371-2BM07-5AJ0</b> <b>6AV6371-2BN07-5AJ0</b> <b>6AV6371-2BP07-5AJ0</b> <b>6AV6371-2BQ07-5AJ0</b> <b>6AV6371-2BR07-5AJ0</b>
<b>As download</b>		
<ul style="list-style-type: none"> <li>128 to 512 PowerTags</li> <li>512 to 2 048 PowerTags</li> <li>2 048 to 8 192 PowerTags</li> <li>8 192 to 65 536 PowerTags</li> <li>65 536 to 102 400 PowerTags</li> <li>102 400 to 153 600 PowerTags</li> <li>153 600 to 262 144 PowerTags</li> </ul>		<b>6AV6371-2BD07-5AJ0</b> <b>6AV6371-2BG07-5AJ0</b> <b>6AV6371-2BM07-5AJ0</b> <b>6AV6371-2BN07-5AJ0</b> <b>6AV6371-2BP07-5AJ0</b> <b>6AV6371-2BQ07-5AJ0</b> <b>6AV6371-2BR07-5AJ0</b>
<b>Complete packages</b>		
<ul style="list-style-type: none"> <li>128 to 512 PowerTags</li> <li>512 to 2 048 PowerTags</li> <li>2 048 to 8 192 PowerTags</li> <li>8 192 to 65 536 PowerTags</li> <li>65 536 to 102 400 PowerTags</li> <li>102 400 to 153 600 PowerTags</li> <li>153 600 to 262 144 PowerTags</li> </ul>		<b>6AV6371-2BD17-5AX0</b> <b>6AV6371-2BG17-5AX0</b> <b>6AV6371-2BM17-5AX0</b> <b>6AV6371-2BN17-5AX0</b> <b>6AV6371-2BP17-5AX0</b> <b>6AV6371-2BQ17-5AX0</b> <b>6AV6371-2BR17-5AX0</b>
<b>As download</b>		
<ul style="list-style-type: none"> <li>128 to 512 PowerTags</li> <li>512 to 2 048 PowerTags</li> <li>2 048 to 8 192 PowerTags</li> <li>8 192 to 65 536 PowerTags</li> <li>65 536 to 102 400 PowerTags</li> <li>102 400 to 153 600 PowerTags</li> <li>153 600 to 262 144 PowerTags</li> </ul>		<b>6AV6371-2BD17-5AJ0</b> <b>6AV6371-2BG17-5AJ0</b> <b>6AV6371-2BM17-5AJ0</b> <b>6AV6371-2BN17-5AJ0</b> <b>6AV6371-2BP17-5AJ0</b> <b>6AV6371-2BQ17-5AJ0</b> <b>6AV6371-2BR17-5AJ0</b>

## HMI Software

## SCADA system SIMATIC WinCC V7

## SIMATIC WinCC V7

## Ordering data

## Article No.

## Article No.

**V7.5 Archive**

- 1 500 archive tags (countable)
- 5 000 archive tags (countable)
- 10 000 archive tags (countable)
- 30 000 archive tags (countable)

**6AV6371-1DQ17-5AX0**  
**6AV6371-1DQ17-5BX0**  
**6AV6371-1DQ17-5CX0**  
**6AV6371-1DQ17-5EX0**

**As download**

- 1 500 archive tags (countable)
- 5 000 archive tags (countable)
- 10 000 archive tags (countable)
- 30 000 archive tags (countable)

**6AV6371-1HQ17-5AX0**  
**6AV6371-1HQ17-5BX0**  
**6AV6371-1HQ17-5CX0**  
**6AV6371-1HQ17-5EX0**

**SIMATIC WinCC software packages****SIMATIC WinCC V7.5 Runtime**

- WinCC RT Client
- 128 PowerTags
- 512 PowerTags
- 2 048 PowerTags
- 8 192 PowerTags
- 65 536 PowerTags

**6AV6382-2AA07-5AX0**  
**6AV6382-2CA07-5AX0**  
**6AV6382-2DA07-5AX0**  
**6AV6382-2EA07-5AX0**  
**6AV6382-2HA07-5AX0**  
**6AV6382-2FA07-5AX0**

**SIMATIC WinCC V7.5 Runtime ASIA**

- WinCC RT Client
- 128 PowerTags
- 512 PowerTags
- 2 048 PowerTags
- 8 192 PowerTags
- 65 536 PowerTags

**6AV6382-2AA07-5AV0**  
**6AV6382-2CA07-5AV0**  
**6AV6382-2DA07-5AV0**  
**6AV6382-2EA07-5AV0**  
**6AV6382-2HA07-5AV0**  
**6AV6382-2FA07-5AV0**

**SIMATIC WinCC Upgrades/  
Software Update Service****SIMATIC WinCC V7.5 Upgrade <sup>1)</sup>****For upgrading the RT version**

- From V7.2/7.3 to V7.5
- From V7.4 to V7.5
- From V7.2/7.3 ASIA to V7.5 ASIA <sup>2)</sup>
- From V7.4 ASIA to V7.5 ASIA <sup>2)</sup>

**6AV6381-2AA07-5AX3**  
**6AV6381-2AA07-5AX4**  
**6AV6381-2AA07-5AV3**  
**6AV6381-2AA07-5AV4**

**As download**

- From V7.2/7.3 to V7.5
- From V7.4 to V7.5

**6AV6381-2AA07-5AK3**  
**6AV6381-2AA07-5AK4**

**For upgrading the RC version**

- From V7.2/7.3 to V7.5
- From V7.4 to V7.5
- From V7.2/7.3 ASIA to V7.5 ASIA <sup>2)</sup>
- From V7.4 ASIA to V7.5 ASIA <sup>2)</sup>

**6AV6381-2AB07-5AX3**  
**6AV6381-2AB07-5AX4**  
**6AV6381-2AB07-5AV3**  
**6AV6381-2AB07-5AV4**

**As download**

- From V7.2/7.3 to V7.5
- From V7.4 to V7.5

**6AV6381-2AB07-5AK3**  
**6AV6381-2AB07-5AK4**

**For upgrading the Client RT version**

- From V7.2/7.3 to V7.5
- From V7.4 to V7.5
- From V7.2/7.3 ASIA to V7.5 ASIA
- From V7.5 ASIA to V7.5 ASIA

**6AV6381-2CA07-5AX3**  
**6AV6381-2CA07-5AX4**  
**6AV6381-2CA07-5AV3**  
**6AV6381-2CA07-5AV4**

**As download**

- From V7.2/7.3 to V7.5
- From V7.4 to V7.5

**6AV6381-2CA07-5AK3**  
**6AV6381-2CA07-5AK4**

**For upgrading the Client RC version**

- From V7.2/7.3 to V7.4 SP1
- From V7.4 to V7.5
- From V7.2/7.3 ASIA to V7.5 ASIA
- From V7.5 ASIA to V7.5 ASIA

**6AV6381-2CB07-5AX3**  
**6AV6381-2CB07-5AX4**  
**6AV6381-2CB07-5AV3**  
**6AV6381-2CB07-5AV4**

**As download**

- From V7.2/7.3 to V7.4 SP1
- From V7.4 to V7.5

**6AV6381-2CB07-4AK3**  
**6AV6381-2CB07-5AK4**

**SIMATIC WinCC Software Update Service (SUS) <sup>3) 4) 5)</sup>****SIMATIC WinCC V7 Update**

Software Update Service for WinCC basic software and options:

- 1 license
- 3 licenses
- 10 licenses

**6AV6381-1AA00-0AX5**  
**6AV6381-1AA00-0BX5**  
**6AV6381-1AA00-0CX5**

**As download**

- 1 license
- 3 licenses
- 10 licenses

**6AV6381-1KA00-0AX5**  
**6AV6381-1KA00-0BX5**  
**6AV6381-1KA00-0CX5**

- <sup>1)</sup> According to licensing provisions, 1 upgrade package must be ordered for each WinCC station
- <sup>2)</sup> Upgrading from V7.X RT/RC ASIA to V7.5 ASIA is carried out using the "respective non-Asia package"
- <sup>3)</sup> The Software Update Service is valid for 1 year. The contract is automatically extended by 1 more year unless canceled 3 months prior to expiration. According to licensing provisions, 1 Software Update Service must be ordered for each WinCC station.
- <sup>4)</sup> Requires the current software version
- <sup>5)</sup> SUS is available as download

Ordering data	Article No.	Article No.		
<i>SIMATIC WinCC system software</i>				
<b>V7.4 SP1</b>				
<b>Runtime packages on DVD</b> Incl. 512 archive tags each; language/script versions: en, de, fr, it, es; with license for <ul style="list-style-type: none"> <li>WinCC RT Client</li> <li>128 PowerTags (RT 128)</li> <li>512 PowerTags (RT 512)</li> <li>2 048 PowerTags (RT 2 048)</li> <li>8 192 PowerTags (RT 8 192)</li> <li>65 536 PowerTags (RT 65 536)</li> <li>102 400 PowerTags (RT 102 400)</li> <li>153 600 PowerTags (RT 153 600)</li> <li>262 144 PowerTags (RT 262 144)</li> </ul>	<b>6AV6381-2CA07-4AX0</b> <b>6AV6381-2BC07-4AX0</b> <b>6AV6381-2BD07-4AX0</b> <b>6AV6381-2BE07-4AX0</b> <b>6AV6381-2BH07-4AX0</b> <b>6AV6381-2BF07-4AX0</b> <b>6AV6381-2BJ07-4AX0</b> <b>6AV6381-2BK07-4AX0</b> <b>6AV6381-2BL07-4AX0</b>	<b>6AV6381-2CA07-4AV0</b> <b>6AV6381-2BC07-4AV0</b> <b>6AV6381-2BD07-4AV0</b> <b>6AV6381-2BE07-4AV0</b> <b>6AV6381-2BH07-4AV0</b> <b>6AV6381-2BF07-4AV0</b> <b>6AV6381-2BJ07-4AV0</b> <b>6AV6381-2BK07-4AV0</b> <b>6AV6381-2BL07-4AV0</b>		
<u>As download</u> <ul style="list-style-type: none"> <li>WinCC RT Client</li> <li>128 PowerTags (RT 128)</li> <li>512 PowerTags (RT 512)</li> <li>2 048 PowerTags (RT 2 048)</li> <li>8 192 PowerTags (RT 8 192)</li> <li>65 536 PowerTags (RT 65 536)</li> <li>102 400 PowerTags (RT 102 400)</li> <li>153 600 PowerTags (RT 153 600)</li> <li>262 144 PowerTags (RT 262 144)</li> </ul>	<b>6AV6381-2CA07-4AH0</b> <b>6AV6381-2BC07-4AH0</b> <b>6AV6381-2BD07-4AH0</b> <b>6AV6381-2BE07-4AH0</b> <b>6AV6381-2BH07-4AH0</b> <b>6AV6381-2BF07-4AH0</b> <b>6AV6381-2BJ07-4AH0</b> <b>6AV6381-2BK07-4AH0</b> <b>6AV6381-2BL07-4AH0</b>			
<b>Complete packages on DVD</b> Language versions: en, de, fr, it, es; with license for <ul style="list-style-type: none"> <li>WinCC RC Client</li> <li>128 PowerTags (RC 128)</li> <li>512 PowerTags (RC 512)</li> <li>2 048 PowerTags (RC 2 048)</li> <li>8 192 PowerTags (RC 8 192)</li> <li>65 536 PowerTags (RC 65 536)</li> <li>102 400 PowerTags (RC 102 400)</li> <li>153 600 PowerTags (RC 153 600)</li> <li>262 144 PowerTags (RC 262 144)</li> </ul>	<b>6AV6381-2CB07-4AX0</b> <b>6AV6381-2BM07-4AX0</b> <b>6AV6381-2BN07-4AX0</b> <b>6AV6381-2BP07-4AX0</b> <b>6AV6381-2BS07-4AX0</b> <b>6AV6381-2BQ07-4AX0</b> <b>6AV6381-2BT07-4AX0</b> <b>6AV6381-2BU07-4AX0</b> <b>6AV6381-2BV07-4AX0</b>	<b>6AV6381-2CB07-4AV0</b> <b>6AV6381-2BM07-4AV0</b> <b>6AV6381-2BN07-4AV0</b> <b>6AV6381-2BP07-4AV0</b> <b>6AV6381-2BS07-4AV0</b> <b>6AV6381-2BQ07-4AV0</b> <b>6AV6381-2BT07-4AV0</b> <b>6AV6381-2BU07-4AV0</b> <b>6AV6381-2BV07-4AV0</b>		
<u>As download</u> <ul style="list-style-type: none"> <li>WinCC RC Client</li> <li>128 PowerTags (RC 128)</li> <li>512 PowerTags (RC 512)</li> <li>2 048 PowerTags (RC 2 048)</li> <li>8 192 PowerTags (RC 8 192)</li> <li>65 536 PowerTags (RC 65 536)</li> <li>102 400 PowerTags (RC 102 400)</li> <li>153 600 PowerTags (RC 153 600)</li> <li>262 144 PowerTags (RC 262 144)</li> </ul>	<b>6AV6381-2CB07-4AH0</b> <b>6AV6381-2BM07-4AH0</b> <b>6AV6381-2BN07-4AH0</b> <b>6AV6381-2BP07-4AH0</b> <b>6AV6381-2BS07-4AH0</b> <b>6AV6381-2BQ07-4AH0</b> <b>6AV6381-2BT07-4AH0</b> <b>6AV6381-2BU07-4AH0</b> <b>6AV6381-2BV07-4AH0</b>			
<b>V7.4 SP1 ASIA</b>				
<b>Runtime packages on DVD</b>				
Incl. 512 archive tags each; language/script versions: en, zh-CN, zh-TW, ko, ja; with license for <ul style="list-style-type: none"> <li>WinCC RT Client</li> <li>128 PowerTags (RT 128)</li> <li>512 PowerTags (RT 512)</li> <li>2 048 PowerTags (RT 2 048)</li> <li>8 192 PowerTags (RT 8 192)</li> <li>65 536 PowerTags (RT 65 536)</li> <li>102 400 PowerTags (RT 102 400)</li> <li>153 600 PowerTags (RT 153 600)</li> <li>262 144 PowerTags (RT 262 144)</li> </ul>				
<b>Complete packages on DVD</b>				
Language versions: en, zh-CN, zh-TW, ko, ja; with license for <ul style="list-style-type: none"> <li>WinCC RC Client</li> <li>128 PowerTags (RC 128)</li> <li>512 PowerTags (RC 512)</li> <li>2 048 PowerTags (RC 2 048)</li> <li>8 192 PowerTags (RC 8 192)</li> <li>65 536 PowerTags (RC 65 536)</li> <li>102 400 PowerTags (RC 102 400)</li> <li>153 600 PowerTags (RC 153 600)</li> <li>262 144 PowerTags (RC 262 144)</li> </ul>				
<b>V7.4 SP1 Powerpacks</b>				
<b>For upgrading from:</b>				
<b>Runtime packages</b>				
<ul style="list-style-type: none"> <li>128 to 512 PowerTags</li> <li>512 to 2 048 PowerTags</li> <li>2 048 to 8 192 PowerTags</li> <li>8 192 to 65 536 PowerTags</li> <li>65 536 to 102 400 PowerTags</li> <li>102 400 to 153 600 PowerTags</li> <li>153 600 to 262 144 PowerTags</li> </ul>			<b>6AV6371-2BD07-4AX0</b> <b>6AV6371-2BG07-4AX0</b> <b>6AV6371-2BM07-4AX0</b> <b>6AV6371-2BN07-4AX0</b> <b>6AV6371-2BP07-4AX0</b> <b>6AV6371-2BQ07-4AX0</b> <b>6AV6371-2BR07-4AX0</b>	
<u>As download</u>				
<ul style="list-style-type: none"> <li>128 to 512 PowerTags</li> <li>512 to 2 048 PowerTags</li> <li>2 048 to 8 192 PowerTags</li> <li>8 192 to 65 536 PowerTags</li> <li>65 536 to 102 400 PowerTags</li> <li>102 400 to 153 600 PowerTags</li> <li>153 600 to 262 144 PowerTags</li> </ul>			<b>6AV6371-2BD07-4AJ0</b> <b>6AV6371-2BG07-4AJ0</b> <b>6AV6371-2BM07-4AJ0</b> <b>6AV6371-2BN07-4AJ0</b> <b>6AV6371-2BP07-4AJ0</b> <b>6AV6371-2BQ07-4AJ0</b> <b>6AV6371-2BR07-4AJ0</b>	
<b>Complete packages</b>				
<ul style="list-style-type: none"> <li>128 to 512 PowerTags</li> <li>512 to 2 048 PowerTags</li> <li>2 048 to 8 192 PowerTags</li> <li>8 192 to 65 536 PowerTags</li> <li>65 536 to 102 400 PowerTags</li> <li>102 400 to 153 600 PowerTags</li> <li>153 600 to 262 144 PowerTags</li> </ul>			<b>6AV6371-2BD17-4AX0</b> <b>6AV6371-2BG17-4AX0</b> <b>6AV6371-2BM17-4AX0</b> <b>6AV6371-2BN17-4AX0</b> <b>6AV6371-2BP17-4AX0</b> <b>6AV6371-2BQ17-4AX0</b> <b>6AV6371-2BR17-4AX0</b>	
<u>As download</u>				
<ul style="list-style-type: none"> <li>128 to 512 PowerTags</li> <li>512 to 2 048 PowerTags</li> <li>2 048 to 8 192 PowerTags</li> <li>8 192 to 65 536 PowerTags</li> <li>65 536 to 102 400 PowerTags</li> <li>102 400 to 153 600 PowerTags</li> <li>153 600 to 262 144 PowerTags</li> </ul>			<b>6AV6371-2BD17-4AJ0</b> <b>6AV6371-2BG17-4AJ0</b> <b>6AV6371-2BM17-4AJ0</b> <b>6AV6371-2BN17-4AJ0</b> <b>6AV6371-2BP17-4AJ0</b> <b>6AV6371-2BQ17-4AJ0</b> <b>6AV6371-2BR17-4AJ0</b>	

## HMI Software

## SCADA system SIMATIC WinCC V7

## SIMATIC WinCC V7

## Ordering data

## Article No.

## Article No.

**V7.4 SP1 archives**

- 1 500 archive tags (countable)
- 5 000 archive tags (countable)
- 10 000 archive tags (countable)
- 30 000 archive tags (countable)

**As download**

- 1 500 archive tags (countable)
- 5 000 archive tags (countable)
- 10 000 archive tags (countable)
- 30 000 archive tags (countable)

**SIMATIC WinCC Upgrades/  
Software Update Service****SIMATIC WinCC V7.4 SP1  
Upgrade <sup>1)</sup>****For upgrading the RT version**

- From V7.X to V7.4 SP1
- From V7.X ASIA to V7.4 SP1 ASIA <sup>2)</sup>

**As download**

- From V7.X to V7.4 SP1

**For upgrading the RC version**

- From V7.X to V7.4 SP1
- From V7.X ASIA to V7.4 SP1 ASIA <sup>2)</sup>

**As download**

- From V7.X to V7.4 SP1

**For upgrading the Client RT  
version**

- From V7.X to V7.4 SP1
- From V7.X ASIA to V7.4 SP1 ASIA

**As download**

- From V7.X to V7.4 SP1

**For upgrading the Client RC  
version**

- From V7.X to V7.4 SP1
- From V7.X ASIA to V7.4 SP1 ASIA

**As download**

- From V7.X to V7.4 SP1

**SIMATIC WinCC Software Update  
Service (SUS) <sup>3) 4) 5)</sup>****SIMATIC WinCC V7 Update**

Software Update Service for WinCC basic software and options:

- 1 license
- 3 licenses
- 10 licenses

**As download**

- 1 license
- 3 licenses
- 10 licenses

**6AV6371-1DQ17-4AX0****6AV6371-1DQ17-4BX0****6AV6371-1DQ17-4CX0****6AV6371-1DQ17-4EX0****6AV6371-1HQ17-4AX0****6AV6371-1HQ17-4BX0****6AV6371-1HQ17-4CX0****6AV6371-1HQ17-4EX0****6AV6381-2AA07-4AX3****6AV6381-2AA07-4AV3****6AV6381-2AA07-4AK3****6AV6381-2AB07-4AX3****6AV6381-2AB07-4AV3****6AV6381-2AB07-4AK3****6AV6381-2CA07-4AX3****6AV6381-2CA07-4AV3****6AV6381-2CA07-4AK3****6AV6381-2CB07-4AX3****6AV6381-2CB07-4AK3****6AV6381-2CB07-4AV3****6AV6381-1AA00-0AX5****6AV6381-1AA00-0BX5****6AV6381-1AA00-0CX5****6AV6381-1KA00-0AX5****6AV6381-1KA00-0BX5****6AV6381-1KA00-0CX5****SIMATIC WinCC V7.5  
communication via  
Industrial Ethernet / PROFIBUS****CP 1612 A2**

PCI card (32-bit) for connection of a PG/PC to Industrial Ethernet (10/100/1 000 Mbps) with RJ45 connection via SOFTNET S7 and SOFTNET PG.

**SOFTNET-IE S7 Version 15**

Software for S7- and S5-comp. communication incl. OPC server, PG/OP communication and NCM PC; up to 64 connections; single license for one installation of runtime software, software and electronic manual on CD-ROM; license key on USB flash drive, Class A. For CP 1612 A2 English/German

- Single license for 1 installation
- Upgrade package for SIMATIC NET Edition 2006 or higher
- Upgrade package for SIMATIC NET V6.0, V6.1, V6.2 and Edition 2005

**SOFTNET-IE S7 Lean Version 15  
(license included in scope of  
supply of WinCC V7.4 SP1)**

Software for S7 and S5-compatible communication including OPC server, PG/OP communication and NCM PC; up to 8 connections; single license for one installation of runtime software, software and electronic manual on CD-ROM, license key on USB flash drive, Class A

For CP 1612 A2, English/German

- Single license for 1 installation
- Upgrade package for SIMATIC NET Edition 2006 or higher
- Upgrade package for SIMATIC NET V6.0, V6.1, V6.2 and Edition 2005

**CP 1623**

PCI Express X1 card (32-bit) for connection of PG/PC to Industrial Ethernet (communications software must be ordered separately)

**CP 1628**

PCI Express X1 card (32-bit) for connecting a PG/PC to Industrial Ethernet (communications software must be ordered separately)

**HARDNET-IE S7 V15**

Software for S7- and S5-comp. communication incl. OPC server, PG/OP communication and NCM PC, single license for one installation of runtime software, software and electronic manual on CD-ROM, license key on USB flash drive, Class A; for CP 1613 A2, CP 1623, CP 1628; English/German

- Single license for 1 installation
- Upgrade package for SIMATIC NET Edition 2006 or higher
- Upgrade package for SIMATIC NET V6.0, V6.1, V6.2 and Edition 2005

**6GK1161-2AA01****6GK1704-1CW15-0AA0****6GK1704-1CW00-3AE0****6GK1704-1CW00-3AE1****6GK1704-1LW15-0AA0****6GK1704-1LW00-3AE0****6GK1704-1LW00-3AE1****6GK1162-3AA00****6GK1162-8AA00****6GK1716-1CB15-0AA0****6GK1716-1CB00-3AE0****6GK1716-1CB00-3AE1**

<sup>1)</sup> According to licensing provisions, 1 upgrade package must be ordered for each WinCC station

<sup>2)</sup> Upgrading from V7.X RT/RC ASIA is carried out using the "respective non-ASIA package"

<sup>3)</sup> The Software Update Service is valid for 1 year. The contract is automatically extended by 1 more year unless canceled 3 months prior to expiration. According to licensing provisions, 1 Software Update Service must be ordered for each WinCC station.

<sup>4)</sup> Requires the current software version

<sup>5)</sup> SUS is available as download

Ordering data	Article No.	Article No.
<b>Communication via PROFIBUS</b>		<b>SIMATIC WinCC V7.4 SP1 communication via Industrial Ethernet/PROFIBUS</b>
<b>CP 5612</b> PCI card (32-bit) for connecting a PG/PC to PROFIBUS (communications software included in WinCC basic package)	<b>6GK1561-2AA00</b>	<b>CP 1612 A2</b> PCI card (32-bit) for connection of a PG/PC to Industrial Ethernet (10/100/1 000 Mbps) with RJ45 connection via SOFTNET S7 and SOFTNET PG. Windows 8.1 and Windows 2012 Server are not supported.
<b>CP 5622</b> PCI Express X1 card (32-bit) for connecting a PG/PC to PROFIBUS (communications software included in WinCC basic package)	<b>6GK1562-2AA00</b>	<b>SOFTNET-IE S7 Version 14 SP1</b> SOFTNET-IE S7 V14 software for S7, S5-comp. communication, OPC; PG/OP communication, configuration software, up to 64 conn.; floating license; runtime software, software and electr. manual; on DVD; license key on USB flash drive; Class A; 2 languages (en, de); for 32/64-bit: Windows 7 SP1 Prof./Ultimate, 64-bit: Windows 8.1Pro; Windows 10 Server 2008 R2 SP1, 2012 R2CP 1612 (no Win 8.1, Win 10 Server 2012, R2)
<b>CP 5711</b> USB adapter for connecting a PG/PC to PROFIBUS or MPI (communications software included in WinCC basic package)	<b>6GK1571-1AA00</b>	<ul style="list-style-type: none"> <li>• Single license for 1 installation</li> <li>• Upgrade package for SIMATIC NET Edition 2006 or higher</li> <li>• Upgrade package for SIMATIC NET V6.0, V6.1, V6.2 and Edition 2005</li> </ul>
<b>CP 5613 A3</b> PCI card (32-bit) for connecting a PC to PROFIBUS (communications software must be ordered separately)	<b>6GK1561-3AA02</b>	<b>SOFTNET-IE S7 Lean V14 SP1 (license included in scope of supply of WinCC V7.4 SP1)</b> SIMATIC NET SOFTNET-IE S7 LEAN V14; SW f. S7, S5-comp. comm., OPC PG/OP comm., config. SW, up to 8 conn. floating license; runtime software, SW and electr. manual on DVD; license key on USB flash drive; Class A; 2 languages (en, de); for 32/64-bit: Win 7 SP1 Prof/Ult, 64-bit: Win 8.1 PRO; Windows 10 Server 2008 R2 SP1, 2012 R2; CP 1612 (no Win 8.1, Win 10, Server 2012, R2)
<b>CP 5614 A3</b> PCI card (32-bit) for connecting a PC to PROFIBUS (communications software must be ordered separately)	<b>6GK1561-4AA02</b>	<ul style="list-style-type: none"> <li>• Single license for 1 installation</li> <li>• Upgrade package for SIMATIC NET Edition 2006 or higher</li> <li>• Upgrade package for SIMATIC NET V6.0, V6.1, V6.2 and Edition 2005</li> </ul>
<b>CP 5623</b> PCI Express X1 card (32-bit) for connection of PG/PC to Industrial Ethernet (communications software must be ordered separately)	<b>6GK1562-3AA00</b>	<b>CP 1623</b> PCI Express X1 card (32-bit) for connection of PG/PC to Industrial Ethernet (communications software must be ordered separately)
<b>HARDNET PB S7</b> Software for S7 communication incl. PG/OP communication, FDL, OPC server, runtime software, software and electronic manual on CD-ROM, license key on USB flash drive, Class A; for CP 5613 A3, CP 5614 A3, CP 5623 English/German	<b>6GK1713-5CB15-0AA0</b> <b>6GK1713-5CB00-3AE0</b> <b>6GK1713-5CB00-3AE1</b>	<b>CP 1628</b> PCI Express X1 card (32-bit) for connecting a PG/PC to Industrial Ethernet (communications software must be ordered separately)
<ul style="list-style-type: none"> <li>• Single license for 1 installation</li> <li>• Upgrade package for SIMATIC NET Edition 2006 or higher</li> <li>• Upgrade package for SIMATIC NET V6.0, V6.1, V6.2 and Edition 2005</li> </ul>		<b>HARDNET IE S7 V13 SP2</b> Software for S7-compatible and S5-compatible communication incl. OPC server, PG/OP communication and NCM PC, single license for one installation of runtime software, software and electronic manual on CD-ROM, license key on USB flash drive, Class A; for CP 1613 A2, CP 1623, CP 1628; English/German
<b>HARDNET PB DP</b> Software for DP protocol incl. PG/OP communication, FDL, DP OPC server; runtime software, software and electronic manual on CD-ROM, license key on USB flash drive, Class A, for CP 5613 A3, CP 5614 A3, CP 5623; English/German	<b>6GK1713-5DB15-0AA0</b> <b>6GK1713-5DB00-3AE0</b> <b>6GK1713-5DB00-3AE1</b>	<ul style="list-style-type: none"> <li>• Single license for 1 installation</li> <li>• Upgrade package for SIMATIC NET Edition 2006 or higher</li> <li>• Upgrade package for SIMATIC NET V6.0, V6.1, V6.2 and Edition 2005</li> </ul>
<ul style="list-style-type: none"> <li>• Single license for 1 installation</li> <li>• Upgrade package for SIMATIC NET Edition 2006 or higher</li> <li>• Upgrade package for SIMATIC NET V6.0, V6.1, V6.2 and Edition 2005</li> </ul>		<b>6GK1704-1CW14-0AA0</b> <b>6GK1704-1CW00-3AE0</b> <b>6GK1704-1CW00-3AE1</b> <b>6GK1704-1LW14-0AA0</b> <b>6GK1704-1LW00-3AE0</b> <b>6GK1704-1LW00-3AE1</b> <b>6GK1162-3AA00</b> <b>6GK1162-8AA00</b>

**HMI Software**

## SCADA system SIMATIC WinCC V7

## SIMATIC WinCC V7

**Ordering data****Article No.***Communication via PROFIBUS***CP 5612**

PCI card (32-bit) for connecting a PG/PC to PROFIBUS (communications software included in WinCC basic package)

**6GK1561-2AA00****CP 5622**

PCI Express X1 card (32-bit) for connecting a PG/PC to PROFIBUS (communications software included in WinCC basic package)

**6GK1562-2AA00****CP 5711**

USB adapter for connecting a PG/PC to PROFIBUS or MPI (communications software included in WinCC basic package)

**6GK1571-1AA00****CP 5613 A3**

PCI card (32-bit) for connecting a PC to PROFIBUS (communications software must be ordered separately)

**6GK1561-3AA02****CP 5614 A3**

PCI card (32-bit) for connecting a PC to PROFIBUS (communications software must be ordered separately)

**6GK1561-4AA02****CP 5623**

PCI Express X1 card (32-bit) for connection of PG/PC to Industrial Ethernet (communications software must be ordered separately)

**6GK1562-3AA00****HARDNET PB S7 V8.2 SP1**

Software for S7 communication incl. PG/OP communication, FDL, OPC server, runtime software, software and electronic manual on CD-ROM, license key on USB flash drive, Class A; for CP 5613 A3, CP 5614 A3, CP 5623  
English/German

- Single license for 1 installation
- Upgrade package for SIMATIC NET Edition 2006 or higher
- Upgrade package for SIMATIC NET V6.0, V6.1, V6.2 and Edition 2005

**6GK1713-5CB08-2AA0****6GK1713-5CB00-3AE0****6GK1713-5CB00-3AE1****HARDNET PB S7 V13 SP2**

Software for S7 communication incl. PG/OP communication, FDL, OPC server, runtime software, software and electronic manual on CD-ROM, license key on USB flash drive, Class A; for CP 5613 A3, CP 5614 A3, CP 5623  
English/German

- Single license for 1 installation
- Upgrade package for SIMATIC NET Edition 2006 or higher
- Upgrade package for SIMATIC NET V6.0, V6.1, V6.2 and Edition 2005

**6GK1713-5CB13-0AA0****6GK1713-5CB00-3AE0****6GK1713-5CB00-3AE1****Article No.****HARDNET PB DP V13 SP2**

Software for DP protocol incl. PG/OP communication, FDL, DP OPC server, runtime software, software and electronic manual on CD-ROM, license key on USB flash drive, Class A, for CP 5613 A3, CP 5614 A3, CP 5623;  
English/German

- Single license for 1 installation
- Upgrade package for SIMATIC NET Edition 2006 or higher
- Upgrade package for SIMATIC NET V6.0, V6.1, V6.2 and Edition 2005

**6GK1713-5DB13-0AA0****6GK1713-5DB00-3AE0****6GK1713-5DB00-3AE1****FMS 5613 V7.1 SP6 (Edition 2008 + SP6)**

Software for FMS protocol incl. PG/OP communication, FDL, OPC server, runtime software, software and electronic manual on CD-ROM, license key on USB flash drive, Class A, for CP 5613 A2, CP 5614 A2, CP 5623;  
English/German

- Single license for 1 installation
- Upgrade package for SIMATIC NET Edition 2006 or higher

**6GK1713-5FB71-3AA0****6GK1713-5FB00-3AE0****WinCC language versions**

SIMATIC WinCC is also offered in simplified Chinese, traditional Chinese, Korean and Japanese especially for Asian markets. These WinCC versions are intended for machine manufacturers, plant constructors and exporters who supply the regions of China, Taiwan, Korea and Japan.

WinCC ASIA includes all familiar WinCC functions and offers in addition the configuration user interface in the respective national language and English. The online help is available in simplified Chinese, traditional Chinese, Korean, Japanese and English. A Chinese, Korean, Japanese or multilingual Windows operating system is required for operation.

The runtime licenses are language-neutral. The English handling program (Automation License Manager – ALM) is executable under the Chinese, Korean and Japanese Windows versions.

In order to use the Asian languages in WinCC, an Asia hardware dongle is required.

More information is available on the Internet at:

<http://www.siemens.com/wincc-v7>

**IPC packages**

There are attractive packages available with SIMATIC Rack PCs (IPC347, IPC547, IPC647, IPC847), SIMATIC Box PCs (IPC227, IPC427, IPC627, IPC827) and SIMATIC Panel PCs (IPC277, IPC477, IPC677) for a completely matched software and hardware package. These IPCs can be configured in different ways for use as single station, server or client.

<http://www.siemens.com/scada-ipc>

**Downloads:**

In most cases, the products can also be obtained as software downloads.

You can find more information on the Software Update Service, license forms, Online Software Delivery and handling your SW licenses with the Automation License Manager here:

<http://www.siemens.com/simatic-licenses>

## Overview



The universal WinCC basic software is the basis for modular expansions. These functional expansions can be obtained in the form of WinCC options and as WinCC Premium add-ons.

WinCC options are created by WinCC Development and are Siemens Industry Automation products. You can obtain support from our Advisory Services and via the central hotline.

### Options for scalable plant configurations

- WinCC/Server  
For configuring a powerful client/server system
- WinCC/Redundancy  
For increasing system availability through redundancy
- WinCC Web Navigator  
For operator control and monitoring of plants via the Internet, in-house intranet or LAN
- WinCC WebUX  
For operator control and monitoring of plants, independent of platforms and browsers, via the Internet, in-house intranet or LAN
- SIMATIC Process Historian  
Central, scalable long-term archive for the whole plant
- SIMATIC TeleControl  
For connecting outlying stations (remote terminal units = RTUs) via telecontrol protocols in a WinCC SCADA system

### Options for greater efficiency in operations management

- WinCC/User Archives  
For managing data records in user archives
- WinCC/DataMonitor  
For displaying and evaluating current process states and historical data on office PCs with standard tools
- WinCC/Performance Monitor  
For analysis and optimization of production on the basis of individual performance indicators
- WinCC/SES (Sequence Execution System)  
Scalable step sequence control for sequence-based processes
- WinCC/Audit
  - Change management
  - Generation of audit trails for engineering and runtime
- WinCC/Calendar Scheduler  
Calendar-based planning of events
- WinCC/ChangeControl
  - Change and version management
  - Generation of audit trails for engineering
- WinCC/Event Notifier  
For sending of notifications triggered by specific events in the WinCC message system
- SIMATIC Information Server  
Web-based, integrated reporting from production to management, based on archived data

### Options for openness and individual system expansions

- WinCC/Connectivity Pack  
Access to WinCC logs via OPC HDA, OPC A&E, OPC XML Server, OPC UA Server/Client and WinCC OLE-DB /OLE-DB
- WinCC/Connectivity Station  
Gateway to WinCC server data via OPC HDA, OPC A&E, OPC XML server, OPC UA Server/Client, and WinCC OLE-DB /OLE-DB from independent computers
- WinCC IndustrialDataBridge  
Configurable connection to databases and IT systems
- WinCC/ODK (Open Development Kit)  
For the use of open programming interfaces and the generation of customer-specific WinCC ActiveX objects

### More information

#### SIMATIC WinCC Options

<http://www.siemens.com/simatic-wincc-options>

## HMI Software

### SIMATIC WinCC options

#### WinCC/Server

#### Overview

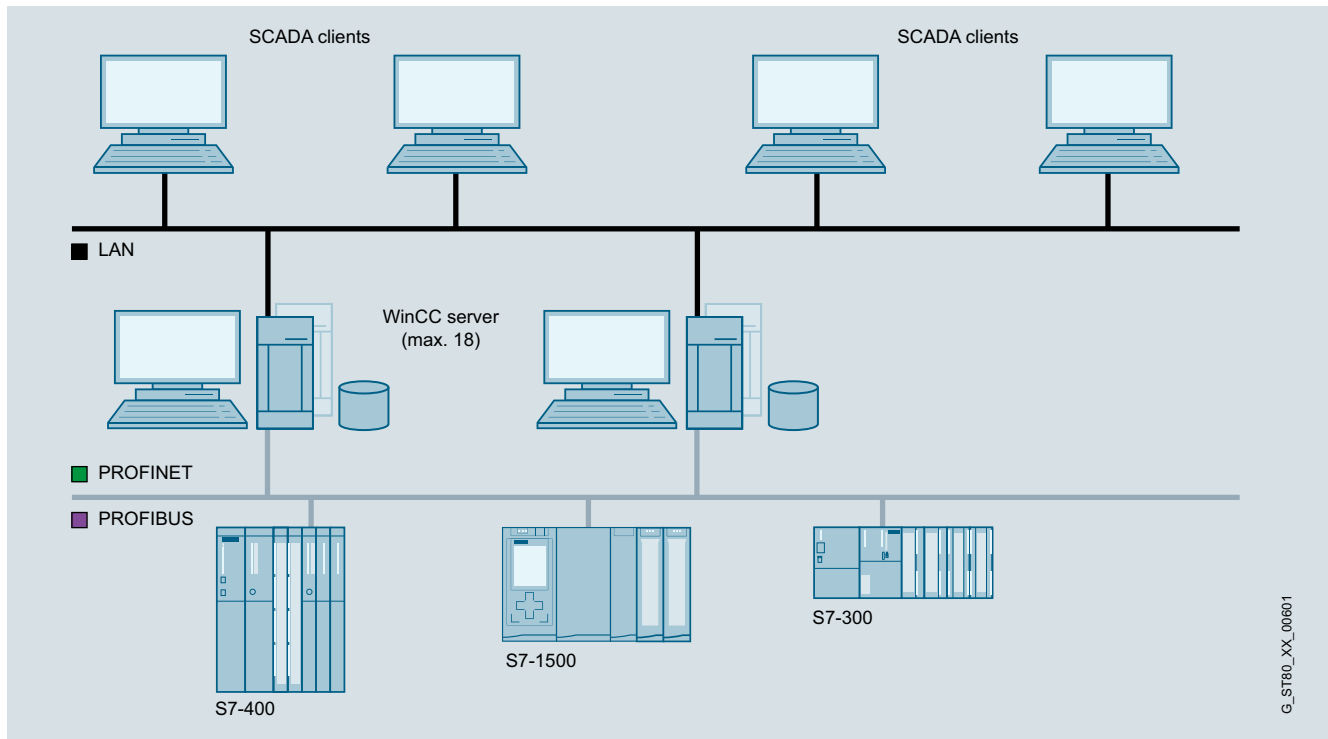

WinCC/Server

#### **SIMATIC WinCC/Server**

- Option for SIMATIC WinCC, which permits the configuration of a powerful client/server system.
- A maximum of 3 clients can be connected to non-server operating systems.
- A number of coordinated HMI stations can be operated in a single group with networked automation systems
- Client/server solution:
  - Client without its own project ("UNI-Client"): One (redundant) server can supply up to 64 clients with process and archive data, messages, images and reports. The clients act as display and operating stations for the project on the server.
  - Client with its own project ("MULTI-Client"): One client can simultaneously access up to 18 (redundant) servers. These servers make the data and images available. This data can be collectively processed and displayed in the client project in order, for example, to implement a system overview across several servers. In this case, one server can supply data to as many as 50 clients.
- Requirement: Network connection (TCP/IP) between the server PC and the connected clients

#### Licenses:

The following licenses are required for configuring a multi-user system:

- WinCC Server license on the server in addition to a WinCC RT license (a server license is required for each server)
- One WinCC RT Client license on each client.

You can find more information on the Software Update Service, license types, online software delivery and handling your SW licenses with the Automation License Manager here: <http://www.siemens.com/simatic-licenses>



### Benefits

- Plant-wide scalability from the single-user system to the client/server solution
- Significantly higher quantity framework, relieving the individual servers and better performance due to distributing the complete application or tasks over several servers
- Low-cost configuration on the client is possible (the minimum RC license is sufficient)

### Application

In a complex plant, WinCC can also be configured as a distributed system according to requirements:

- Functional distribution (e.g. message servers, archive servers, etc.) or
- Distribution according to the physical plant structure (e.g. body-in-white, paintshop, etc.)

### Function

Each client can access more than one server at a time. Clients can also be used for configuration on the server.

A configuration of WinCC clients as a central Web server – as a distributed system if required - with an overview of all server projects in the system is also possible.

For WinCC clients, only the smallest runtime license WinCC RT client is required. In order to also facilitate configuration on WinCC clients, the smallest complete license WinCC RC client is required. Remote configuration is possible if WinCC clients without their own project (Uniclents) on the server project are configured. This makes it possible to configure inexpensive operator and configuration stations in a network.

### Ordering data

#### SIMATIC WinCC/Server V7.5

- Runtime software, single license
- as download, runtime software, single license

#### SIMATIC WinCC/Server V7.4 SP1

- Runtime software, single license
- as download, runtime software, single license

### Article No.

**6AV6371-1CA07-5AX0**  
**6AV6371-1HA07-5AX0**

**6AV6371-1CA07-4AX0**  
**6AV6371-1HA07-4AX0**

### More information

You can find more information at:

<http://www.siemens.com/wincc-server>

## HMI Software

### SIMATIC WinCC options

#### WinCC/Redundancy

##### Overview

###### WinCC/Redundancy

- Option for SIMATIC WinCC, supporting the parallel operation of two interfaced WinCC single-user systems or process data servers for mutual monitoring
- If one of the two server PCs or one of the two WinCC stations fails, the second one will take over control of the entire system. Once the failed server or station is restored to operation, the process value archives are copied to the restored partner.

###### Licenses

The WinCC/Redundancy option includes licenses for both redundant servers. A Redundancy license is required on each of the two servers in addition to other necessary licenses.

You can find more information on the Software Update Service, license types, online software delivery and handling your SW licenses with the Automation License Manager here:  
<http://www.siemens.com/simatic-licenses>

##### Benefits

- Increased system availability with continuous data integrity
- Automatic changeover of client in the event of failure of a server or failure of the communication to a server
- Continuous operator control and visualization thanks to automatic client changeover to the intact server
- Automatic updating of all archives in the background after rectification of the fault

##### Function

Normally, two WinCC stations or process data servers run in parallel. Each station has its own process connection and its own data archives. WinCC/Redundancy ensures automatic matching of system and user archive data.

If one of the two server computers or WinCC stations fails, the second will take over the archiving of messages and process data, thereby ensuring seamless data integrity. In client/server mode, the clients are automatically switched from the failed server to the redundant partner. This ensures continuous plant visualization and operation on every operator station.

When the failed partner resumes operation, all process values, messages and data archived during the fail period are automatically matched with the partner. This process runs in the background and does not affect plant continuity. Once this is complete, two equivalent servers/stations will be available again.

Communication with the SIMATIC S7 PLC can also be configured with redundancy (an H Series SIMATIC S7 is required) by plugging in two communication modules and configuring two communication paths (S7-REDCONNECT software package). The use of failsafe H Series SIMATIC S7 PLCs can, if required, further increase availability at control level.

##### Ordering data

##### Article No.

###### SIMATIC WinCC/Redundancy V7.5

- runtime software, single license for 2 installations
- as download, runtime software, single license for 2 installations

6AV6371-1CF07-5AX0

6AV6371-1HF07-5AX0

###### SIMATIC WinCC/Redundancy V7.4 SP1

- runtime software, single license for 2 installations
- as download, runtime software, single license for 2 installations

6AV6371-1CF07-4AX0

6AV6371-1HF07-4AX0

##### More information

You can find more information at:

<http://www.siemens.com/wincc-redundancy>

Overview

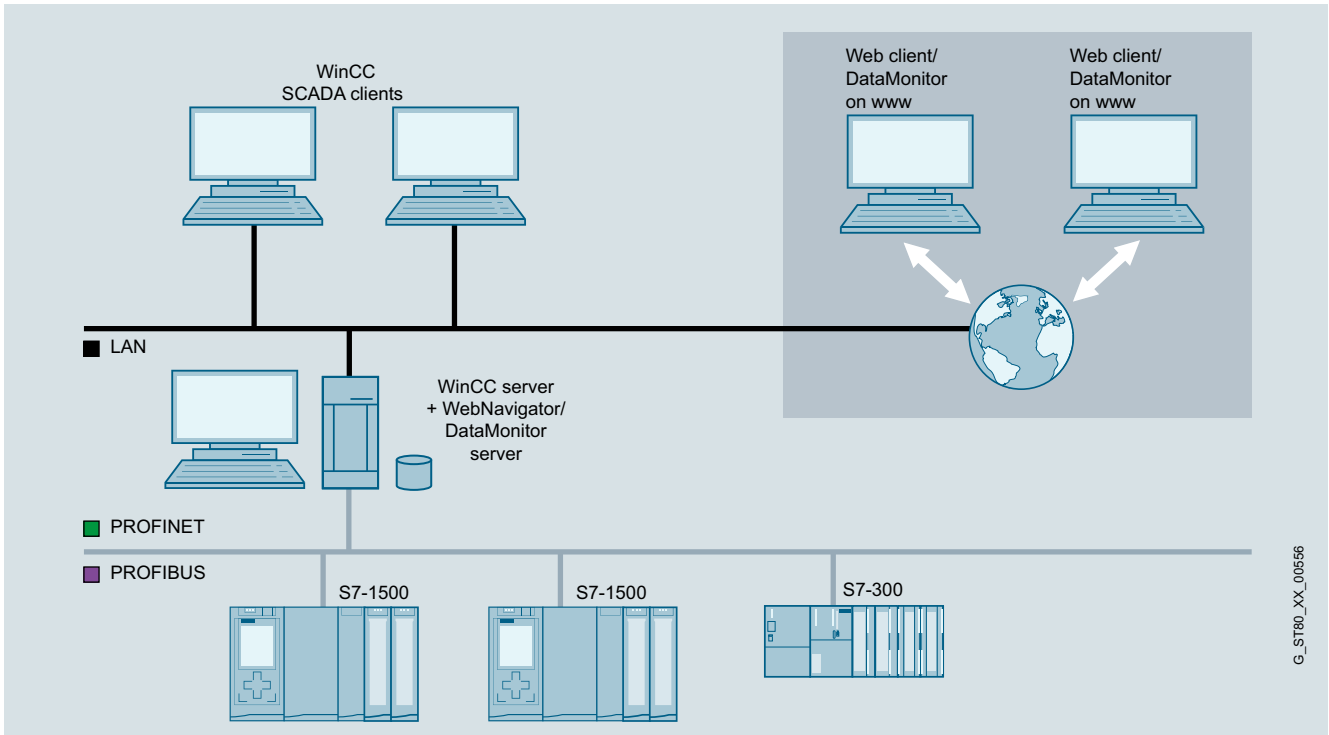

G\_ST80\_XX\_00556

WinCC Server as web server

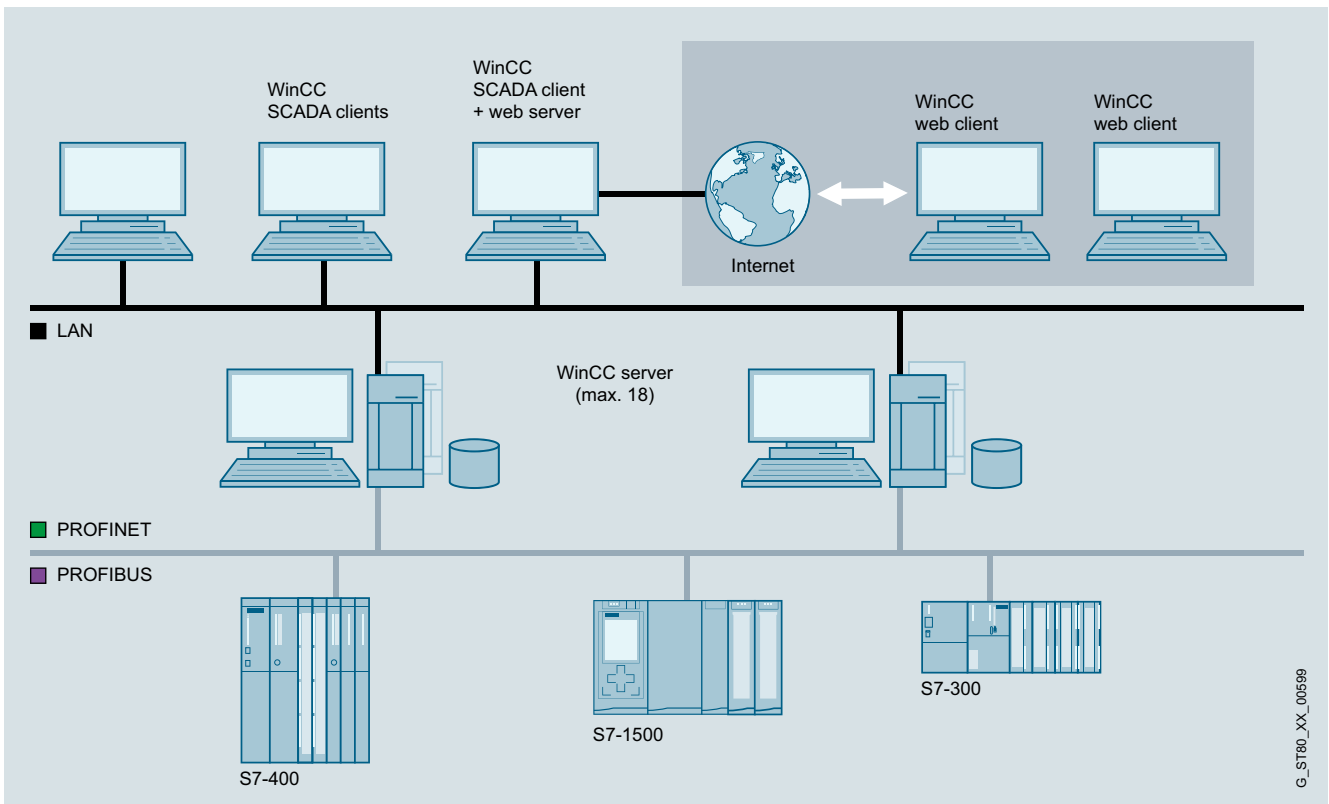

G\_ST80\_XX\_00599

WinCC MultiClient as web server

## HMI Software

### SIMATIC WinCC options

#### WinCC WebNavigator

##### Overview (continued)

##### WinCC WebNavigator

- Option for SIMATIC WinCC or WinCC Runtime Professional for operating and monitoring plants over the Internet, company Intranet or LAN
- Configuration from:
  - A web server with SIMATIC WinCC as single-user or server version and a web client that permits operator control and monitoring of a current WinCC project using the Internet Explorer. In combination with WinCC V7, the WebNavigator Server can be operated on a MultiClient

##### Licenses

- A (server-based) license is required for the WebNavigator. This is a graduated license based on the number of simultaneous web client access operations and can be incremented at any time using additive web client licenses (countable licenses)
- The WebNavigator client software can be installed as many times as required without the need for a license.
- A (client-based) license is required for the WebNavigator diagnostics. This provides access to all web servers with a WebNavigator Server or WebNavigator Diagnostic Server license.
- The WinCC/WebUX and WinCC/WebNavigator licenses can be combined, if necessary.

You can find more information on the Software Update Service, license types, online software delivery and handling your SW licenses with the Automation License Manager <http://www.siemens.com/simatic-licenses>

##### Note:

When accessing the operator stations via the WinCC WebNavigator option, suitable protective measures (including IT security such as network segmentation) should be taken in order to ensure safe operation of the system.

You will find more information on the topic of Industrial Security on the Internet at:

<http://www.siemens.com/industrialsecurity>

##### Benefits

- Operator control and monitoring across long distances and on different platforms (PC, local panel, mobile PDA)
- Large configurations with up to 150 operator stations (depending on the plant complexity and communication load)
- Optimally tailored clients for operating and monitoring, analysis, service and diagnostics
- Acceptance of configuration data for the web, generally without changes
- Minimum maintenance costs due to central software administration
- With the WinCC Web Viewer (WinCC Viewer RT), the process screens can be displayed on the web client independently of the Internet Explorer. Settings for the client are made on the client itself. The WinCC Web Viewer can also be used in conjunction with the MS Terminal Service.
- The SIMATIC WinCC WebNavigator can also be operated in "view only" mode and is thus used as tool for monitoring and navigating using Internet Explorer or WinCC Web Viewer (WinCC Viewer RT).
- Security is increased by adjustable automatic logout. If an automatic logout is to take place, an absolute or inactive time period can be set.

##### Application

In addition to the standard WebNavigator licensing, there is the "Diagnostics Client" with identical functionality but different licensing. It is especially suitable for the following applications:

- Remote diagnostics/operation of several unmanned WinCC server stations
- Central control rooms that monitor several web servers via one user interface
- Maintenance personnel who require guaranteed access to the server at any time, regardless of the number of users already logged on to the server. On the server side, only one WebNavigator Diagnostics Server license or, alternatively, one Standard WebNavigator license is required.

##### Design

##### Thin Client solutions

The WebNavigator can also run under Windows Server 2008 R2 SP1 or Windows Server 2012 R2 terminal services. The Windows Server 2008 R2 SP1 or Windows Server 2012 R2 operating system is required. This makes it possible, for example, to connect SIMATIC Thin Clients to the WinCC server as visualization stations.

For this purpose, the Windows terminal services must be installed on the PC on which the web client is installed. The Windows Server 2008 R2 SP1 or Windows Server 2012 R2 operating system is required.

Up to 25 Thin Clients can be connected to one terminal server.

Applications:

- Mobile devices
- Handhelds
- Rugged on-site visualizations

##### Function

The WinCC basic system makes setting up and configuring a WebNavigator Server very easy. WinCC process screens to be visualized via the Internet are created as usual using the graphic editor.

To display WinCC process screens on the web client, the Microsoft Internet Explorer or browser is used independent of the supplied WinCC Web Viewer (WinCC Viewer RT).

The operator on the web client is integrated in the central WinCC user administration and can operate and monitor the system according to the configured access rights.

The WebNavigator supports all standard security mechanisms that can be used for applications on the Internet, e.g. routers, firewalls and proxy servers.

Ordering data	Article No.	Article No.	
<p><b>SIMATIC WinCC WebNavigator as from Runtime Professional V14 and WinCC as from V7.4<sup>2)</sup></b></p> <p>Single license, license key on USB flash drive</p> <ul style="list-style-type: none"> <li>• 1 client license (countable)</li> <li>• 3 client licenses (countable)</li> <li>• 10 client licenses (countable)</li> <li>• 30 client licenses (countable)</li> <li>• 100 client licenses (countable)</li> </ul> <p>as download<sup>1)</sup></p> <p>Single license, license key download. Email address mandatory</p> <ul style="list-style-type: none"> <li>• 1 client license (countable)</li> <li>• 3 client licenses (countable)</li> <li>• 10 client licenses (countable)</li> <li>• 30 client licenses (countable)</li> <li>• 100 client licenses (countable)</li> </ul>	<p><b>6AV6362-1AB00-0BB0</b></p> <p><b>6AV6362-1AD00-0BB0</b></p> <p><b>6AV6362-1AF00-0BB0</b></p> <p><b>6AV6362-1AJ00-0BB0</b></p> <p><b>6AV6362-1AM00-0BB0</b></p>	<p><b>WinCC WebNavigator for Runtime Professional Powerpacks (up to WinCC V13)</b></p> <p>Single license, license key only on USB flash drive</p> <ul style="list-style-type: none"> <li>• 3 to 10 clients</li> <li>• 10 to 25 clients</li> <li>• 25 to 50 clients</li> <li>• 50 to 100 clients</li> <li>• 100 to 150 clients</li> </ul> <p>As download</p> <p>Single license, license key only on USB flash drive</p> <ul style="list-style-type: none"> <li>• 3 to 10 clients</li> <li>• 10 to 25 clients</li> <li>• 25 to 50 clients</li> <li>• 50 to 100 clients</li> <li>• 100 to 150 clients</li> </ul>	<p><b>6AV2107-2KF00-0BD0</b></p> <p><b>6AV2107-2KH00-0BD0</b></p> <p><b>6AV2107-2KK00-0BD0</b></p> <p><b>6AV2107-2KM00-0BD0</b></p> <p><b>6AV2107-2KP00-0BD0</b></p>
<p><b>SIMATIC WinCC WebNavigator Diagnostics Client</b></p> <p>for WinCC V14 Runtime Professional and WinCC as from V7.4</p> <ul style="list-style-type: none"> <li>• Standard scope of supply</li> <li>• As download</li> </ul>	<p><b>6AV6362-1BA00-0BB0</b></p> <p><b>6AV6362-1BA00-0AH0</b></p>	<p><b>WinCC WebNavigator Diagnostics Server/Client for WinCC (TIA Portal)</b></p> <p>Single license, license key only on USB flash drive</p> <ul style="list-style-type: none"> <li>• WinCC WebDiagnostics Server for Runtime Professional, Runtime SW</li> <li>• WinCC WebDiagnostics Client for Runtime Professional, Runtime SW</li> </ul>	<p><b>6AV2107-0KR00-0BB0</b></p> <p><b>6AV2107-0KT00-0BB0</b></p>
<p><b>WinCC WebNavigator Load Balancing</b></p> <p>For WinCC V7.4 only</p> <ul style="list-style-type: none"> <li>• Load Balancing</li> <li>• Load Balancing Step Up</li> </ul> <p>As download</p> <p>RT-SW, single license, license key download. Email address mandatory</p> <ul style="list-style-type: none"> <li>• Load Balancing</li> <li>• Load Balancing Step Up</li> </ul>	<p><b>6AV6362-1FA00-0BB0</b></p> <p><b>6AV6362-1GA00-0BB0</b></p>	<p>As download</p> <p>Single license, license key download only, email address required for delivery</p> <ul style="list-style-type: none"> <li>• WinCC WebDiagnostics Server for Runtime Professional, Runtime SW</li> <li>• WinCC WebDiagnostics Client for Runtime Professional, Runtime SW</li> </ul>	<p><b>6AV2107-0KR00-0BH0</b></p> <p><b>6AV2107-0KT00-0BH0</b></p>
<p><b>SIMATIC WinCC WebNavigator for Runtime Professional (WinCC V13)</b></p> <p>Single license, license key only on USB flash drive</p> <ul style="list-style-type: none"> <li>• 3 clients, runtime software</li> <li>• 10 clients</li> <li>• 25 clients</li> <li>• 50 clients</li> <li>• 100 clients</li> <li>• 150 clients</li> </ul> <p>As download</p> <p>Single license, license key download only, email address required for delivery</p> <ul style="list-style-type: none"> <li>• 3 clients</li> <li>• 10 clients</li> <li>• 25 clients</li> <li>• 50 clients</li> <li>• 100 clients</li> <li>• 150 clients</li> </ul>	<p><b>6AV2107-0KD00-0BB0</b></p> <p><b>6AV2107-0KF00-0BB0</b></p> <p><b>6AV2107-0KH00-0BB0</b></p> <p><b>6AV2107-0KK00-0BB0</b></p> <p><b>6AV2107-0KM00-0BB0</b></p> <p><b>6AV2107-0KP00-0BB0</b></p>		
	<p><b>6AV2107-0KD00-0BH0</b></p> <p><b>6AV2107-0KF00-0BH0</b></p> <p><b>6AV2107-0KH00-0BH0</b></p> <p><b>6AV2107-0KK00-0BH0</b></p> <p><b>6AV2107-0KM00-0BH0</b></p> <p><b>6AV2107-0KP00-0BH0</b></p>		

<sup>1)</sup> Current information and availability regarding the new type of delivery can be found at: <http://www.siemens.com/customized-automation>

<sup>2)</sup> As from WinCC V14 the licenses are cumulative, i.e. one 10 client license and one 30 client license permit access by 40 clients.

A license is not required for the engineering system for configuring the runtime option.

# HMI Software

## SIMATIC WinCC options

### WinCC WebNavigator

#### Ordering data

##### SIMATIC WinCC WebNavigator for Runtime Professional (WinCC V13)

- 1 client
- 5 clients

##### As download

- 1 client
- 5 clients

#### Article No.

6AV2107-0KB00-0BB0  
6AV2107-0KE00-0BB0

6AV2107-0KB00-0BH0  
6AV2107-0KE00-0BH0

##### SIMATIC WinCC WebNavigator for Runtime Professional Powerpack (WinCC V13)

- 1 -> 3 clients
- 3 -> 5 clients
- 5 -> 10 clients

##### As download

- 1 -> 3 clients
- 3 -> 5 clients
- 5 -> 10 clients

6AV2107-2KD00-0BD0  
6AV2107-2KE00-0BD0  
6AV2107-2KG00-0BD0

6AV2107-2KD00-0BJ0  
6AV2107-2KE00-0BJ0  
6AV2107-2KG00-0BJ0

##### WinCC/Web Navigator V7.3 (WinCC V7.3)

- 1 client license
- 3 client licenses
- 5 client licenses
- 10 client licenses
- 25 client licenses
- 50 client licenses
- 100 client licenses
- 150 client licenses

##### As download

RT-SW, single license, license key download.

Email address mandatory

- 1 client license
- 3 client licenses
- 5 client licenses
- 10 client licenses
- 25 client licenses
- 50 client licenses
- 100 client licenses
- 150 client licenses

6AV6371-1DH07-3LX0  
6AV6371-1DH07-3AX0  
6AV6371-1DH07-3MX0  
6AV6371-1DH07-3BX0  
6AV6371-1DH07-3CX0  
6AV6371-1DH07-3DX0  
6AV6371-1DH07-3GX0  
6AV6371-1DH07-3HX0

6AV6371-1HH07-3LX0  
6AV6371-1HH07-3AX0  
6AV6371-1HH07-3MX0  
6AV6371-1HH07-3BX0  
6AV6371-1HH07-3CX0  
6AV6371-1HH07-3DX0  
6AV6371-1HH07-3GX0  
6AV6371-1HH07-3HX0

#### Article No.

##### WinCC/Web Navigator Powerpacks (WinCC 7.3)

- From 1 to 3 clients
- From 3 to 5 clients
- From 5 to 10 clients
- From 10 to 25 clients
- From 25 to 50 clients
- From 50 to 100 clients
- From 100 to 150 clients

##### As download

RT-SW, single license, license key download.

Email address mandatory

- From 1 to 3 clients
- From 3 to 5 clients
- From 5 to 10 clients
- From 10 to 25 clients
- From 25 to 50 clients
- From 50 to 100 clients
- From 100 to 150 clients

6AV6371-1DH07-3LA0  
6AV6371-1DH07-3AM0  
6AV6371-1DH07-3MB0  
6AV6371-1DH07-3BC0  
6AV6371-1DH07-3CD0  
6AV9681-1DH07-3DG0  
6AV9681-1DH07-3GH0

##### WinCC/Web Navigator Diagnostics Client (for WinCC 7.3)

- Standard scope of supply
- As download

6AV6371-1DH07-3EX0  
6AV6371-1HH07-3EX0

##### WinCC/Web Navigator Diagnostics Server (for WinCC 7.3)

- Standard scope of supply
- As download

6AV6371-1DH07-3FX0  
6AV6371-1HH07-3FX0

##### WinCC/Web Navigator Upgrade (WinCC 7.3)

Is included in the corresponding WinCC upgrade from WinCC 6.2 and higher

##### WinCC/WebNavigator Load Balancing (WinCC 7.3)

- Load Balancing
- Load Balancing Step Up

6AV6371-1DH07-3JX0  
6AV6371-1DH07-3FJ0

##### As download

RT-SW, single license, license key download.

Email address mandatory

- Load Balancing
- Load Balancing Step Up

6AV6371-1HH07-3JX0  
6AV6371-1HH07-3FJ0

You can find more information at:

<http://www.siemens.com/wincc-webnavigator>

## Overview

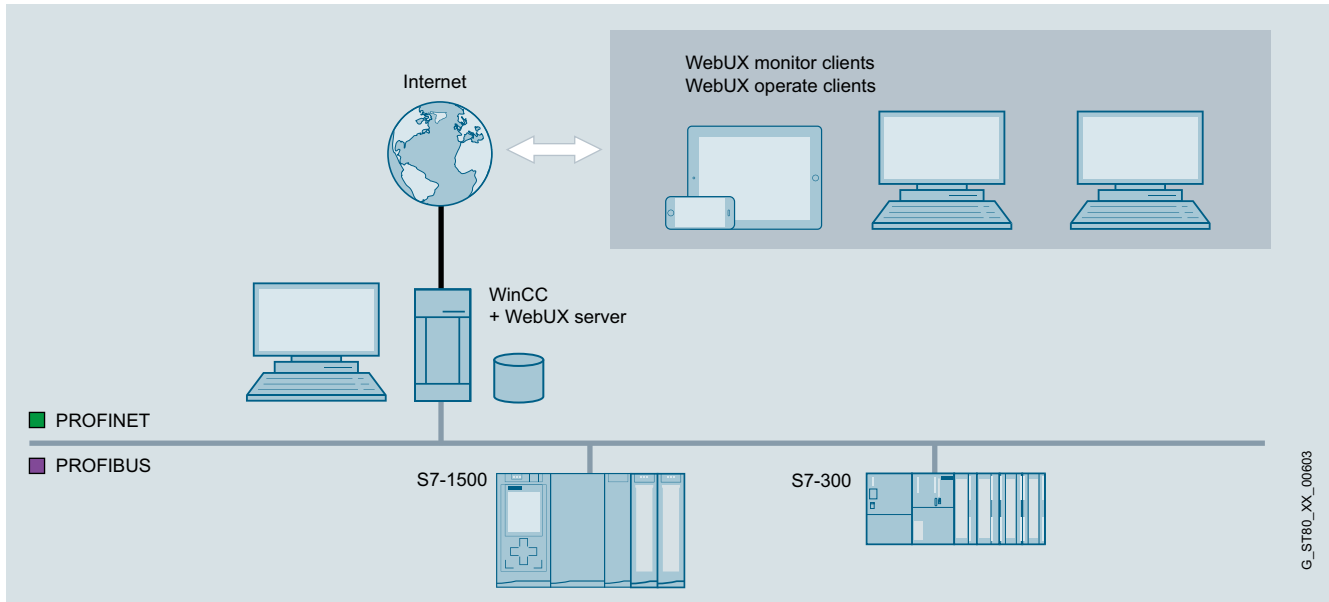
**WinCC WebUX**

The WinCC WebUX option permits mobile, platform and browser-independent operator control and monitoring via the Internet or the in-house intranet or LAN.

WinCC WebUX is delivered with the WinCC system. Following installation, the WinCC Runtime system operates as WinCC WebUX server.

The images for the WinCC WebUX are created using the graphic editor. The WinCC picture is stored in the corresponding format in the project through the "web-capable" picture property. Using the service platform IIS (Internet Information Server), the files are made available for the Internet.

No installation on the client is required for using the WebUX. WinCC WebUX can be used independent of the industrial sector, for example in service for the acknowledgment of alarm messages, in quality assurance for monitoring important production data, or in management for obtaining a quick overview of key production figures.

The WebUX server itself does not require a basic license. Clients that are simultaneously logged into the server are licensed. Regarding licensing, it is differentiated between Monitor Clients (read only) and Operate Clients (reading and writing of values). WinCC WebUX can be used immediately due to a free Monitor Client that is included in the WinCC package.

Licenses:

- A (server-based) license is required to use the WebUX server. This is a graduated license based on the number of simultaneous web access operations and can be incremented at any time.
- We distinguish between Monitor and Operate Clients for licensing purposes.
- Flexible number of clients thanks to additive (countable) licenses (floating client)
- The WinCC/WebUX and WinCC/WebNavigator licenses can be combined, if necessary.
- The WinCC server version and version of the mobile clients do not have to be the same
- One free Monitor Client in the WinCC system

You can find more information on the Software Update Service, license types, online software delivery and handling your SW licenses with the Automation License Manager here: <http://www.siemens.com/simatic-licenses>

## HMI Software

### SIMATIC WinCC options

#### WinCC WebUX

##### Benefits

###### WinCC Engineering

- Fast configuration using the graphic editor
- No expensive training in web technologies is required due to the use of WinCC standard tools
- Can be used without complex additional configuration on the client

###### Maintenance, servicing and IT

- No WinCC-specific installation on the clients required
- No WinCC-specific maintenance at the data terminal equipment required
- The WinCC WebUX server version and version of the mobile clients do not have to be the same
- Standard user authorizations on the client suffice

###### Line management and plant operator

- Mobile operator control and monitoring using commercially available mobile devices
- Uniform look and feel both on the mobile devices and on the WinCC station
- Secure communication via HTTPS und SSL certificates
- No entry costs, since a Monitoring client is included in the WinCC package
- Flexible licensing due to additive, Floating Client licenses
- Secured plant data as a basis for decision-making

###### Highlights

- Can be used on HTML5-capable and SVG-capable data terminal equipment without installation on the client

##### Function

Supported functions in WebUX of WinCC V7.4/V14:

- Language selection by setting the Web language in the User Administrator
- Support of following WinCC objects:
  - Most WinCC standard objects and WinCC pipe objects
  - WinCC Smart objects (picture window, I/O field, graphic object, status display, text list, multi-line text, combo box, list box)
  - WinCC Windows objects
- The following WinCC controls are supported:
  - WinCC AlarmControl
  - WinCC OnlineTrendControl
  - OnlineTrend Web Control
  - OnlineTable Web Control
  - Ruler Web Control
  - Slider Control
  - Digital/Analog Clock Control
  - Gauge Control
  - WebBrowser Control
- Dynamizations by means of VB script or via the dynamics dialog
- User administration via SIMATIC Logon
- System events for user logon and logoff

###### Note:

Browser-dependent display is occasionally possible. Minor differences in display and behavior are possible for the different browser versions.

Please also note the supported functionalities in the respective documentations.

##### Ordering data

##### Article No.

*SIMATIC WinCC WebUX as from Runtime Professional V14 and WinCC as from V7.3*

###### Monitor Clients:

- 1 client (countable)
- 3 clients (countable)
- 10 clients (countable)
- 30 clients (countable)
- 100 clients (countable)

###### As download

- 1 client (countable)
- 3 clients (countable)
- 10 clients (countable)
- 30 clients (countable)
- 100 clients (countable)

6AV6362-2AB00-0BB0  
6AV6362-2AD00-0BB0  
6AV6362-2AF00-0BB0  
6AV6362-2AJ00-0BB0  
6AV6362-2AM00-0BB0

###### Operate Clients

- 1 client (countable)
- 3 clients (countable)
- 10 clients (countable)
- 30 clients (countable)
- 100 clients (countable)

###### As download

- 1 client (countable)
- 3 clients (countable)
- 10 clients (countable)
- 30 clients (countable)
- 100 clients (countable)

6AV6362-2BB00-0BB0  
6AV6362-2BD00-0BB0  
6AV6362-2BF00-0BB0  
6AV6362-2BJ00-0BB0  
6AV6362-2BM00-0BB0

6AV6362-2BB00-0AH0  
6AV6362-2BD00-0AH0  
6AV6362-2BF00-0AH0  
6AV6362-2BJ00-0AH0  
6AV6362-2BM00-0AH0

###### Note:

The licenses are cumulative, i.e. one 10-client license and one 30-client license permit access by 40 clients.

Operate licenses can be used as Monitor licenses as of V14/V7.4.

Licenses from V7.3 can continue to be used in V7.4 without upgrading.

##### More information

You can find more information at:

<http://www.siemens.com/wincc-webux>



**Overview****WinCC/User Archives**

- Option for SIMATIC WinCC for managing data sets in user archives that contain related data.
- WinCC and its automation partners (e.g. a SIMATIC S7 controller) write these data sets and exchange them if required.

The WinCC/User Archives option can also be used in the context of the WinCC/WebNavigator (see also WinCC/WebNavigator option).

Licenses:

A license is only required for the server (or single-user system).

You can find more information on the Software Update Service, license types, online software delivery and handling your licenses with the Automation License Manager here:

<http://www.siemens.com/simatic-licenses>

**Benefits**

- Storing and managing of any user data in data sets
- Flexible display using ActiveX controls
- Simple linking of data set fields to the process via direct tag linking
- Import/export functions for further processing with other tools (e.g. MS Excel)

**Function**

- Input of parameter sets (e.g. operating parameters of a machine) in WinCC, storage of the sets in the user archive, and forwarding to the automation level
- Continuous acquisition of production parameters by the automation system and forwarding of the parameters to WinCC at the end of the shift
- Acquisition of batch data
- Specification of production parameters
- Management of warehousing data

WinCC user archives are created and assigned data in a user-friendly way using a dedicated editor. Special ActiveX controls are used for displaying data from the user archives at runtime.

Data sets and fields from user archives are linked to the process via direct tag linking.

Import and export functions support read-in/out of data via external applications (e.g. MS Excel). Freely selectable filter criteria allow clear representation of data sets.

WinCC provides functions for free organization of the data storage in the user archives that affect archives, data sets and fields. Archives can thus be generated, opened, closed, or reset, and data sets or field contents can be read, written or overwritten.

Sequence archives can accommodate batch data, shift production data, or also product quality data, and meet legal obligations for verification thanks to gap-free recording.

**Ordering data****Article No.****SIMATIC WinCC/User Archives**

- Option for SIMATIC WinCC V7.4, Runtime software, single license
- Option for SIMATIC WinCC V7.3, Runtime software, single license

**6AV6371-1CB07-4AX0****6AV6371-1CB07-3AX0**As download

- Option for SIMATIC WinCC V7.4, Runtime software, single license
- Option for SIMATIC WinCC V7.3, Runtime software, single license

**6AV6371-1HB07-4AX0****6AV6371-1HB07-3AX0****More information**

You can find more information at:

<http://www.siemens.com/wincc-user-archives>

## HMI Software

### SIMATIC WinCC options

#### WinCC DataMonitor

#### Overview

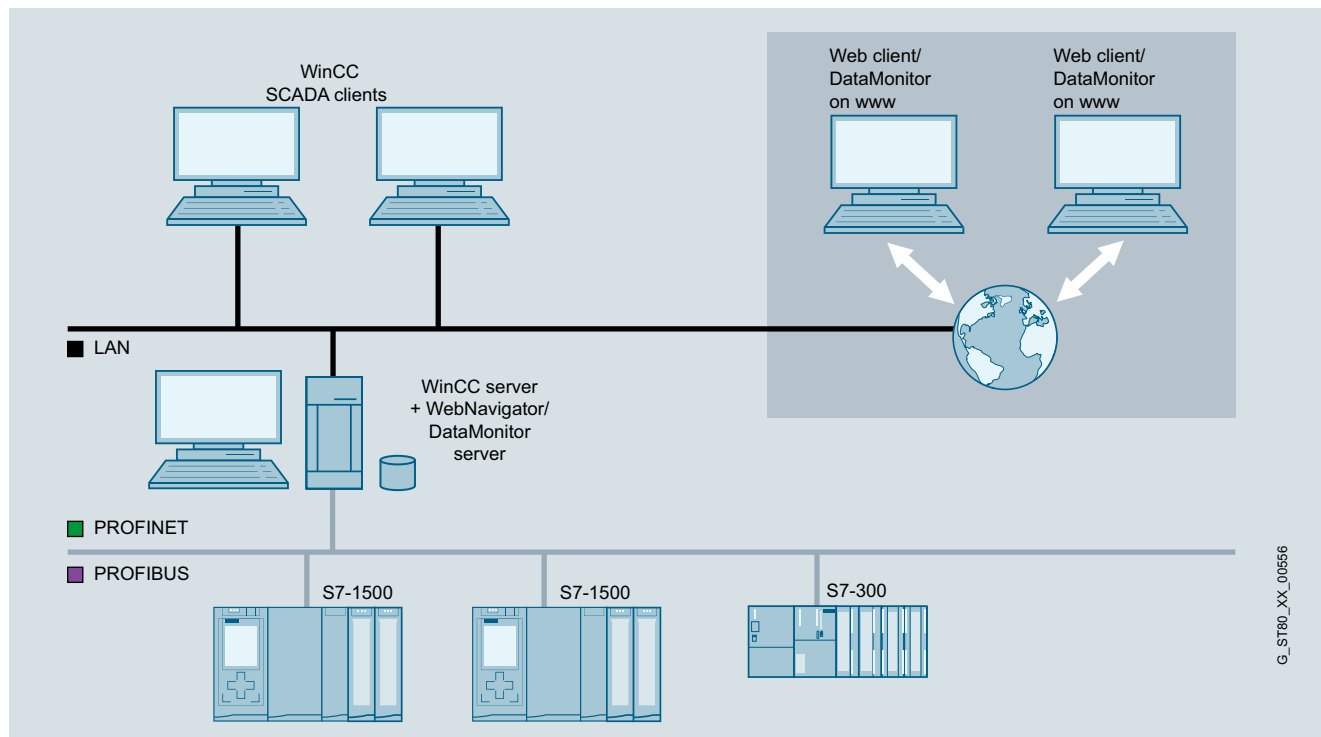

WinCC DataMonitor

- The WinCC DataMonitor is used for displaying and evaluating current process states and historical data on office PCs using standard tools such as Microsoft Internet Explorer or Microsoft Excel. The DataMonitor Client is supported by a web server with current and historical process data and alarms. All staff ranging from machine operators to corporate managers can use the DataMonitor to obtain information. In combination with WinCC V7 and with the aid of the multiclient architecture, access can be made to several lower-level WinCC stations.
- DataMonitor is a suite of Internet-capable tools:
  - **Process Screens**  
Tool exclusively for monitoring and navigating via WinCC or WinCC Runtime Professional screens using the WinCC Web Viewer (WinCCViewer RT) in the "view only" mode
  - **Excel Workbooks**  
Logging tool that integrates WinCC or WinCC Runtime Professional Archive and online values into Microsoft Excel and supports online analysis
  - **Published Reports**  
Event- or time-driven execution of Excel or PDF reports for the output of process data and analysis results.
  - **WebCenter**  
Individual configuration of Internet pages and compilation of information within a portal.
- DataMonitor does not require manual client installation because it loads the required components from the DataMonitor server
- There is no installation required on the client for the WebCenter, Trends and Alarms functions.

#### Licenses:

- A (server-based) license is required for the WinCC DataMonitor. This is a graduated license based on the number of simultaneous web client access operations and can be incremented at any time using additive web client licenses (countable licenses).
- The DataMonitor client software can be installed as many times as required without the need for a license.

You can find more information on the Software Update Service, license types, online software delivery and handling your licenses with the Automation License Manager here: <http://www.siemens.com/simatic-licenses>

#### Benefits

- Information can be compiled online individually during runtime via the Internet/Intranet.
- Efficiently monitor and analyze production lines.
- Easily collect and distribute information.
- Substantiate decisions with reports.
- View production status anywhere and anytime.

G\_ST80\_XX\_00556

**Benefits** (continued)**Highlights:**

- With the WebCenter function, archive tags can be accessed without changing the configuration system.
- Dedicated Internet pages can be created for displaying data with the WebCenter. For this purpose, for example, a bar chart, a pie chart or a trend graph is available.
- The analyses can be made with relative or absolute time specification. This enables comparisons of identical time periods on different days.
- Reports can be made available on the DataMonitor server or emailed automatically based on time intervals or triggered by events.
- Support of Microsoft Internet Explorer version, including "tabbed browsing".

**Function**

- All tools are fully Internet-compatible and, therefore, support access via any type of connection (LAN, GSM, radio, modem, Internet, etc.).
- All popular security mechanisms such as login/password, firewalls, encryption, etc. are supported.
- Users can combine the available tools at will. Licensing only takes into account simultaneous access to one web server.
- For display purposes, screens from the WinCC project can be used or special overview displays configured. Animations, scripts, navigation and access rights remain valid.
- The WinCC DataMonitor has purely a display function
- Company-wide Excel reports, which contain historical and current process values, can be stored centrally for general access (reports, statistics). However, local queries to meet individual requirements can also be compiled and executed online. Plot and tabular representation are supported for archive data already swapped out.
- Enhanced user management for the WebCenter in order to assign individual Internet pages and created reports to specific user groups.
- A search function simplifies the management of connections to the WinCC server

**Ordering data****Article No.****SIMATIC WinCC DataMonitor as from Runtime Professional V14 and WinCC as from V7.4<sup>2)</sup>**

Standard scope of supply

- 1 client license (countable)
- 3 client licenses (countable)
- 10 client licenses (countable)
- 30 client licenses (countable)

As download<sup>1)</sup>

- 1 client license (countable)
- 3 client licenses (countable)
- 10 client licenses (countable)
- 30 client licenses (countable)

6AV6362-3AB00-0BB0  
6AV6362-3AD00-0BB0  
6AV6362-3AF00-0BB0  
6AV6362-3AJ00-0BB0

**SIMATIC WinCC DataMonitor for Runtime Professional (up to WinCC V13)**

Single license, license key only on USB flash drive

- 1 client
- 3 clients
- 10 clients
- 25 clients
- 50 clients

As download<sup>1)</sup>

Single license, license key download only, email address required for delivery

- 1 client
- 3 clients
- 10 clients
- 25 clients
- 50 clients

6AV2107-0LB00-0BB0  
6AV2107-0LD00-0BB0  
6AV2107-0LF00-0BB0  
6AV2107-0LH00-0BB0  
6AV2107-0LK00-0BB0

6AV2107-0LB00-0BH0  
6AV2107-0LD00-0BH0  
6AV2107-0LF00-0BH0  
6AV2107-0LH00-0BH0  
6AV2107-0LK00-0BH0

**SIMATIC WinCC DataMonitor for Runtime Professional Powerpacks (WinCC V13)**

Single license, license key only on USB flash drive

- From 1 to 3 clients
- From 3 to 10 clients
- From 10 to 25 clients
- From 25 to 50 clients

As download<sup>1)</sup>

Single license, license key download only, email address required for delivery

- From 1 to 3 clients
- From 3 to 10 clients
- From 10 to 25 clients
- From 25 to 50 clients

6AV2107-2LD00-0BD0  
6AV2107-2LF00-0BD0  
6AV2107-2LH00-0BD0  
6AV2107-2LK00-0BD0

6AV2107-2LD00-0BJ0  
6AV2107-2LF00-0BJ0  
6AV2107-2LH00-0BJ0  
6AV2107-2LK00-0BJ0

<sup>1)</sup> Current information and availability regarding the new type of delivery can be found at: <http://www.siemens.com/tia-online-software-delivery>

<sup>2)</sup> As from WinCC V14 the licenses are cumulative, i.e. one 10 client license and one 30 client license permit access by 40 clients.

A license is not required for the engineering system for configuring the runtime option.

**More information**

You can find more information at:

<http://www.siemens.com/wincc-datamonitor>

## HMI Software

### SIMATIC WinCC options

#### WinCC/PerformanceMonitor

#### Overview

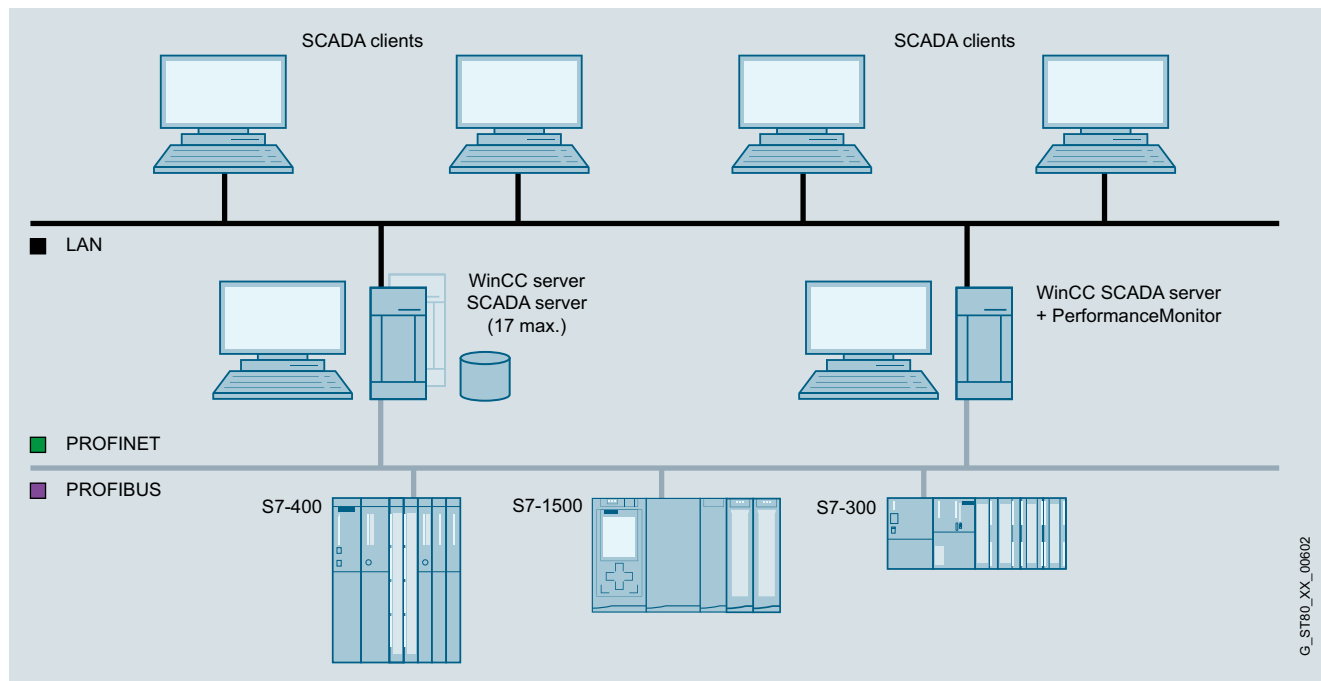

WinCC/PerformanceMonitor

#### **WinCC/PerformanceMonitor – Analysis and optimization of production based on individual performance indicators**

The WinCC/PerformanceMonitor facilitates flexible calculation and powerful analysis of plant-specific key performance indicators (KPIs). The indicators provide the basis for deriving optimization potential, thus enabling productivity enhancement.

They relate to individual machine groups, plant sections or production lines. The elements to be monitored are designated as equipment. Indicators are calculated based on operands which are derived from already configured WinCC tags. By combining them with associated values, more accurate production correlations can be highlighted, such as quality/supplier dependencies. The calculation formulas used are quick and simple to create in WinCC.

Analysis of the indicators and their operands can be carried out in the WinCC system at any time. Indicators, along with their associated values if required, can be clearly displayed in bar graphs, allowing easy comparison. In addition, the input values of each performance indicator can be shown via an integrated analysis function (drill-down). The Gantt chart illustrates the chronological sequence of the operands. The table display lists the archived values, allowing subsequent correction if required. Performance indicators calculated online, either cyclically or triggered by a tag, can be written to WinCC tags for further processing in WinCC, and display in WinCC images, for example.

The PerformanceMonitor can be combined with the Web Navigator for distribution on the Internet, and with the Information Server for reporting purposes. Integration into WinCC ensures fast configuration and complete transparency across all machine and plant data as a basis for optimizing plant productivity.

- The WinCC/PerformanceMonitor can be installed on a WinCC stand-alone system, WinCC server or WinCC client project (WinCC RT Client license), and consists of an engineering client as well as a runtime user interface.
- The WinCC/PerformanceMonitor provides ActiveX control elements for embedding in WinCC images.
  - PerformanceControl: Bar graphs for displaying performance indicators in relation to context values, showing the operands for cause analysis in each case.
  - Gantt chart: Chronological sequence of time-based operands
  - TableControl: Tabular listing of operands with post correction option.
- With the help of the integrated configuration environment, operands are calculated (based on tags) which can be used to calculate key statistics at the set evaluation time.
- For analysis via intranet or Internet, the controls of the WinCC/PerformanceMonitor are available when using the WinCC/WebNavigator.
- The SIMATIC Information Server can be used for generating plant-specific, Web-based reports (predefined and expandable).

#### Licensing:

- The basic package comprises a configuration environment, runtime controls (bars, Gantt, tables) and a license for archiving 30 values.
- The logged values (operands, context) form the basis of the analysis. If more values are to be archived, the number of (additive) archive values can be increased in steps of 30, 100, 300 or 1 000 (countable tags).

You can find more information on the Software Update Service, license types, online software delivery and handling your licenses with the Automation License Manager here: <http://www.siemens.com/simatic-licenses>

**Benefits****Management and quality assurance**

Complete transparency throughout the machine park as the basis for optimizing plant productivity:

- Recording of downtimes, localizing causes and reasons for failure times, and monitoring of equipment efficiency.
- Decision making based on performance indicators.
- Global availability of information server reports means they can be used by different user groups.
- Recognition of production correlations by combining associated values with indicators such as material used.

Servicing and maintenance:

Support through cyclic and process-event triggered calculation of characteristics:

- Standardization of new plants by defining controller-based status information for key figure calculation
- Individual, targeted analysis using plant-specific performance indicators.
- Weak-point analysis in production processes and recording of undesirable process activities.
- Cause analysis by examining "drill down to operands" calculation basis.
- Identification of the events that lead to cost-intensive failures.

Line management and plant operator:

The operator is always kept up-to-date by graphical display of the characteristics.

- Later modification of archived input values.
- Continuous information at the operator interface thanks to integration in the WinCC user interface.
- Alarm messaging of limit violations and trend recording through cyclic calculation of characteristics.
- Integration into the WinCC system means it is not necessary to train operating personnel
- Quick detection of weaknesses in the process using cyclic calculation of characteristics.

WinCC Engineering:

- Quick configuration of WinCC operator displays with WinCC and web-based reports from the Information Server.
- Minimal networking overhead by using the WinCC infrastructure in the local network as well as for the Internet.
- Short familiarization times and simple configuration using familiar tools for user interfaces and reports (WinCC, SIMATIC Information Server)
- Minimal configuration overhead due to the type-instance concept
- Minimal administrative overhead by using the WinCC infrastructure in the local network as well as for the Internet.

Highlights:

Creation of performance indicators by the WinCC engineer with subsequent utilization by all user groups in the manufacturing company on WinCC stations or Internet clients.

**Application**

All user groups benefit from the PerformanceMonitor, from the application engineer to management-level evaluators. The engineer can use the application environment integrated in WinCC to derive individual formulas for calculating performance indicators.

Management uses Web-based reporting without the need for installation on standard computers. For maintenance, the web client of the WebNavigator can be used for analysis with the bar (for performance), progression (Gantt) and table controls. Performance indicators can be displayed on local user interfaces using standard WinCC resources to keep machine operators up to date. The service engineer can analyze the plant from his/her workstation using the WinCC Client, the Webclient of the WinCC/WebNavigator, for example. At the management level, it is possible to access Web-based reports without the need for installation on standard computers.

**Function**

- Structuring of the production plant in equipment units constituting central elements for evaluation
- Use of structured tags in order to facilitate implementation of machine status models
- WinCC tags are compressed to an operand using formulas
- Calculated operands are stored in the archive
- Archived operands are used as input values for calculating performance indicators
- Bar graphs for analyzing performance indicators and root cause determination (drill down)  
Indicator input values (operands) can be displayed if required.
- Tabular presentation of all operands (input values)
- Progression diagrams (Gantt charts) of time-based operands
- Cyclic or event-triggered calculation results are written to WinCC tags
- WinCC Runtime, alarm logging and trend logging can utilize cyclically-calculated values
- Database information and evaluations can be displayed at every WinCC station
- Information server reports can be displayed on independent PC workstations

## HMI Software

### SIMATIC WinCC options

#### WinCC/PerformanceMonitor

Ordering data	Article No.	Ordering data	Article No.
<p><i>WinCC/PerformanceMonitor</i></p> <p><b>WinCC/PerformanceMonitor Basic Package</b></p> <p>including 30 PerformanceMonitor archive tags</p> <ul style="list-style-type: none"> <li>WinCC/PerformanceMonitor V7.5</li> <li>WinCC/PerformanceMonitor V7.4 SP1</li> </ul> <p><u>As download</u></p> <ul style="list-style-type: none"> <li>WinCC/PerformanceMonitor V7.5</li> <li>WinCC/PerformanceMonitor V7.4 SP1 for WinCC V7.4 SP1</li> </ul>	<p><b>6AV6372-2DG07-5AA0</b></p> <p><b>6AV6372-2DG07-4AA0</b></p> <p><b>6AV6372-2HG07-5AA0</b></p> <p><b>6AV6372-2HG07-4AA0</b></p>	<p><i>WinCC/PerformanceMonitor Upgrade</i></p> <p><b>V7.4 to V7.5</b></p> <ul style="list-style-type: none"> <li>Standard software</li> <li>as download</li> </ul> <p><b>V7.2/7.3 to V7.5</b></p> <ul style="list-style-type: none"> <li>Standard software</li> <li>As download</li> </ul> <p><b>V7.x to V7.4 SP1</b></p> <ul style="list-style-type: none"> <li>Standard software</li> <li>As download</li> </ul>	<p><b>6AV6372-2DG07-5AX4</b></p> <p><b>6AV6372-2KG07-5AX4</b></p> <p><b>6AV6372-2DG07-5AX3</b></p> <p><b>6AV6372-2KG07-5AX3</b></p> <p><b>6AV6372-2DG07-4AX3</b></p> <p><b>6AV6372-2KG07-4AX3</b></p>
<p><b>Option for WinCC/PerformanceMonitor V7.4 SP1 and V7.5 Basic Package</b></p> <ul style="list-style-type: none"> <li>30 additive PerformanceMonitor archive tags</li> <li>100 additive PerformanceMonitor archive tags</li> <li>300 additive PerformanceMonitor archive tags</li> <li>1 000 additive PerformanceMonitor archive tags</li> </ul> <p><u>As download</u></p> <ul style="list-style-type: none"> <li>30 additive PerformanceMonitor archive tags</li> <li>100 additive PerformanceMonitor archive tags</li> <li>300 additive PerformanceMonitor archive tags</li> <li>1 000 additive PerformanceMonitor archive tags</li> </ul>	<p><b>6AV6372-2CG20-0BA0</b></p> <p><b>6AV6372-2CG20-0CA0</b></p> <p><b>6AV6372-2CG20-0DA0</b></p> <p><b>6AV6372-2CG20-0EA0</b></p> <p><b>6AV6372-2JG20-0BA0</b></p> <p><b>6AV6372-2JG20-0CA0</b></p> <p><b>6AV6372-2JG20-0DA0</b></p> <p><b>6AV6372-2JG20-0EA0</b></p>		

You can find more information at:

<http://www.siemens.com/wincc-performancemonitor>

### Overview

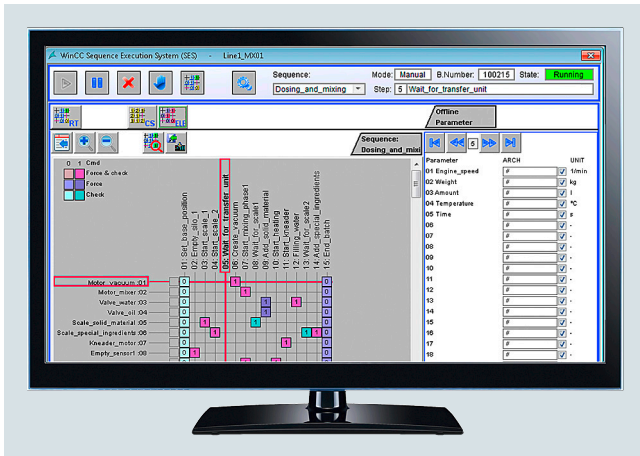

WinCC/SES V7.4

### WinCC/SES

The WinCC/SES (Sequence Execution System) is designed for the sequential control of recipe and sequence-based processes in production. WinCC/SES is especially suitable for production plants in which dosing, mixing and material transport are important process actions.

Sequence controls can be structured with a high degree of flexibility, with the production steps being defined in a clear configuration interface and freely combined to form individual process sequences. In addition both the step sequences and the parameters can be modified online during production runs.

WinCC/SES helps the user to fine tune their production processes by allowing them to easily combine automatic sequences with manual interventions. This means that operators can react quickly and intervene in the running process, for example when quality of the raw materials fluctuates or if a different sequence among the production steps becomes necessary to facilitate more versatile production paths.

WinCC/SES also offers a high level of system availability and rapid response times since the program sequence takes place directly on the automation controller instead of on the PC.

#### Licenses:

In addition to the basic SIMATIC WinCC V7.4 software, WinCC/SES V7.4 also requires STEP 7 version 5.5 SP4 to be installed. The basic pack allows the sequential control of two plant sections. Extension Units can be used to increase the number of plant sections by 5 in each case (countable licenses).

You can find more information on the Software Update Service, license types, online software delivery and handling your SW licenses with the Automation License Manager here: <http://www.siemens.com/simatic-licenses>

### Benefits

- Combination of automatic step sequence with manual fine adjustment of the production sequences (e.g. if behavior of natural raw materials fluctuates)
- Due to the pre-assembled SES visualization control and the SES function blocks, a high degree of engineering efficiency is achieved, because the plant engineer or configurator saves both engineering and testing and commissioning time as a result.
- SES allows flexible paths through the production and is thus an enabler for even utilization of the individual production plants
- Increased quality due to efficient operations management
- SES fulfils the real-time requirement because the steps run in the PLC
- High availability due to the execution of the step sequencer in the PLC.
- Low training costs due to uniform procedures for all step sequencers
- Minimal engineering outlay due to standardization

## HMI Software

### SIMATIC WinCC options

#### WinCC/SES (Sequence Execution System)

##### Application

WinCC/SES is used in production facilities in which dosing, mixing and material transport play an important role. In such facilities, raw materials stored in tanks, silos or containers must be combined in the right process sequence with reaction containers and processing machines. This is done over several processing steps until the end product.

In WinCC/SES, the plant operator defines the production steps of his production units, specifies the production parameters such as the setpoints, and defines the corresponding production sequences in the form of step sequencers, which may comprise numerous single steps.

The SES operator control provides live visualization of the steps, including intuitive operation. After the start of production, all of the steps and production parameters such as the setpoints and actual values, as well as the current status of the production sequence are displayed in the form of an overview in the SES operator control.

During operation, the operator can thus quickly and easily readjust production sequences by manually intervening in the automatic step sequence online and, if necessary, by jumping to another step or changing the step sequence. This is required, for example, if the quality of natural raw materials fluctuates or if a different order of individual production steps is generally needed for flexible paths through production.

High system availability and fast response times are characteristic of WinCC/SES, because all of the step sequencers do not run on the PC. Instead, they are executed directly on the PLCs. As a result, the user gets a real-time behavior, on the one hand, due to the processing on the PLCs and, on the other hand, this also increases the protection against failures, because a batch continues to be produced without changes if the PC/SCADA fails.

##### Ordering data

##### Article No.

###### **SIMATIC WinCC/SES Sequence Execution System**

Software option package for the sequential control of recipe and sequence-based processes in production, functional enhancement for SIMATIC WinCC; electronic documentation in English, German

###### **V7.5 <sup>1) 2)</sup>**

- Basic Package (incl. 2 units)  
For configuration of the Sequence Execution System
- Extension 5 units (countable)  
For increasing the number of units <sup>2)</sup>

**6AV6372-2DJ07-5AA0**

**6AV6372-2BJ07-5BA0**

###### Download

- Basic Package (incl. 2 units)
- Extension 5 units (countable)

**6AV6372-2HJ07-5AA0**

**6AV6372-2JJ07-5BA0**

###### Upgrades

- Basic Package Upgrade from 7.4 to 7.5 <sup>1)</sup>
- Extension 5 units Upgrade from 7.4 to 7.5 <sup>1)</sup>
- Basic Package Upgrade from 7.2/3 to 7.5 <sup>1)</sup>
- Extension 5 units Upgrade from 7.2/3 to 7.5 <sup>1)</sup>

**6AV6372-2DJ17-5AA1**

**6AV6372-2BJ17-5BA1**

**6AV6372-2DJ17-5AA0**

**6AV6372-2BJ17-5BA0**

###### As download

- Basic Package Upgrade from 7.4 to 7.5 <sup>1)</sup>
- Extension 5 units Upgrade from 7.4 to 7.5 <sup>1)</sup>
- Basic Package Upgrade from 7.2/3 to 7.5 <sup>1)</sup>
- Extension 5 units Upgrade from 7.2/3 to 7.5 <sup>1)</sup>

**6AV6372-2HJ17-5AA1**

**6AV6372-2JJ17-5BA1**

**6AV6372-2HJ17-5AA0**

**6AV6372-2JJ17-5BA0**

###### **V7.4 <sup>1) 2)</sup>**

- Basic package (incl. 2 units)  
For configuration of the Sequence Execution System
- Extension 5 units  
For increasing the number of units <sup>2)</sup>

**6AV6372-2DJ07-4AA0**

**6AV6372-2BJ07-4BA0**

###### Download

- Basic Package (incl. 2 units)
- Extension 5 units

**6AV6372-2HJ07-4AA0**

**6AV6372-2JJ07-4BA0**

###### Upgrades

- Basic Package Upgrade 7.4 <sup>1)</sup>
- Extension 5 units Upgrade 7.4 <sup>1)</sup>

**6AV6372-2DJ17-4AA0**

**6AV6372-2BJ17-4BA0**

###### As download

- Basic Package Upgrade 7.4 <sup>1)</sup>
- Extension 5 units Upgrade 7.4 <sup>1)</sup>

**6AV6372-2HJ17-4AA0**

**6AV6372-2JJ17-4BA0**

<sup>1)</sup> Also compatible with WinCC V7.4 SP1

<sup>2)</sup> Additionally requires STEP7 V5.5. Based on SIMATIC S7-300 from S7-315 or higher, redundancy and WebNavigator are not supported.

##### More information

You can find more information at:

<http://www.siemens.com/wincc-ses>



**Overview****WinCC/Audit & WinCC/ChangeControl**

- **WinCC/ChangeControl** is used to *trace engineering changes* in a tamper-proof long-term audit trail database, called the audit trail for short. All engineering changes are automatically recorded in the audit trail. This provides a traceable record of every change that has been made, as well as enabling the causes to be deduced and the system downtimes to be minimized.  
To begin tracing at a defined project status, a project version definition is provided that contains all data and files of a WinCC project version. The project version definition naturally provides the ability to reactivate earlier project versions. Document management is also provided, which manages and archives intermediate status for system graphics, reports or user files and stores change information of the user. The audit viewer with helpful filter functions enables the audit trail to be quickly and easily evaluated, exported or even printed out.
- **WinCC/Audit** includes the full functionality of **WinCC/ChangeControl** and is also used for *tracing all operations*. All operations are automatically recorded in the audit trail at RT.
- The WinCC/Audit or WinCC/ChangeControl options and SIMATIC Logon support users in the validation of their plants and meet the requirements according to FDA CFR 21 Part 11.

Licenses:

WinCC Audit complete licenses include the runtime and configuration licenses (RC).

Licensing applies to one engineering station (configuration) and one operating station (runtime) for which an audit trail is to be generated.

An RC license also always includes a runtime (RT) license. Only one RT license is required for each additional operating station with audit trail.

**Benefits**

- Quick and easy traceability configuration
- Gap-free and automated recording of engineering changes and operator actions in an audit trail
- Reduction in plant downtimes thanks to fast analysis of the gap-free recorded audit trail information
- Logging of defined WinCC project status with all database information and files of the application
- Gap-free documentation of the project version definition procedures with version number, user and comments
- Complete tracing support by WinCC single and multi-station systems, single and multi-project solutions, Client/Server architecture
- Extensive reduction in engineering outlay in order to meet the requirements of FDA 21 CFR Part11 & EU 178/2002
- Compliance with the requirements of the Food and Drug Administration (FDA) for the food, beverages and tobacco industries

**Design**

WinCC/ChangeControl and WinCC/Audit consist of five components:

- The audit editor for configuration the audit trail content
- The project version definition for logging WinCC projects
- Document management for automatic archiving and versioning of WinCC plant mimics, scripts, reports, and project-specific documents, and the recording of the associated change information
- The audit viewer for visualizing, exporting and printing WinCC and WinCC flexible audit trails. The viewer is available as an executable program under Windows, as well as OCX with WinCC Runtime.
- The audit trail, which tracks all changes in respect of both engineering and plant operation in a separate SQL database. The audit trail can be set up as a central audit trail for a number of projects or even just for a single project.

WinCC/ChangeControl and WinCC/Audit support both single-user and multi-user systems, client/server architectures and even the WinCC redundancy system. No redundant audit trail is created however.

**Function****WinCC/ChangeControl**

WinCC/ChangeControl is a functional subset of WinCC/Audit. WinCC/ChangeControl is for tracing engineering changes in the engineering phase or in online operation. All change data is recorded in an audit trail.

There are two types of engineering changes:

- those that change the WinCC database or are executed through the WinCC Explorer, such as e.g. changes to tag management or creating a user group,

and those

- limited to changing files, the so-called document administration.

The document management manages system images, scripts and log layouts and customer-specific documents and stores respective intermediate versions as backups. All of these documents or files are subject to a change process, i.e. documents can be booked out for processing, booked in for finalization and intermediate versions can be retrieved from backup storage with a rollback function.

The project version definition as a component of WinCC/ChangeControl archives WinCC projects and creates reproducible project status or defined start-time points for starting tracing. An audit trail is also provided with information on who has created which project version or which version has been reproduced or deleted.

Configuring the audit trail, the project version definition and the document management is simple, quick and comfortable.

## HMI Software

### SIMATIC WinCC options

#### WinCC/Audit & WinCC/ChangeControl

##### Function (continued)

The audit trail data is visualized from WinCC, as well as from WinCC flexible via the audit viewer, an executable program under Windows. The data can also be evaluated with the audit viewer OCX in Runtime by WinCC however.

Users select the desired view of the audit trail information via filters or selection criteria and can export the data to an Excel file or print it on a printer. Audit trail information is tamper-proof and can thus not be modified or deleted. An export function can be used to swap out the audit trail to an XML file or to archive it.

##### WinCC/Audit

WinCC/Audit has all of the functionality of WinCC/ChangeControl and is also used for tracing user operations in RT operation. Tracing can be used for determining who, when and what conditions the machine has undergone. In addition to recording operator activities, the audit trail also records the starting and modifying of recipes or user logs. At specific objects or events, such as function buttons or sliders, the user can also record activities of an individual nature such as e.g., pressing a function button, moving sliders and other actions with a so-called audit entry function in the audit trail.

A WinCC/ChangeControl RC license or a WinCC/Audit RC license is required for configuring the audit trail. One RT license is required for each station (client/server) to be monitored. One RC license always includes one RT license.

##### Ordering data

##### Article No.

###### *WinCC/ChangeControl*

###### **For the configuration of the audit trail incl. RT**

- WinCC V7.5
- WinCC V7.4 SP1

**6AV6371-1DV27-5AX0**  
**6AV6371-1DV27-4AX0**

###### As download

- WinCC V7.5
- WinCC V7.4 SP1

**6AV6371-1HV27-5AX0**  
**6AV6371-1HV27-4AX0**

###### *WinCC/Audit*

###### **WinCC/Audit RC**

For the configuration of the audit trail incl. RT

- WinCC V7.5
- WinCC V7.4 SP1

**6AV6371-1DV17-5AX0**  
**6AV6371-1DV17-4AX0**

###### As download

- WinCC V7.5
- WinCC V7.4 SP1

**6AV6371-1HV17-5AX0**  
**6AV6371-1HV17-4AX0**

###### **WinCC/Audit RT**

Creation of audit trails in RT

- WinCC V7.5
- WinCC V7.4 SP1

**6AV6371-1DV07-5AX0**  
**6AV6371-1DV07-4AX0**

###### As download

- WinCC V7.5
- WinCC V7.4 SP1

**6AV6371-1HV07-5AX0**  
**6AV6371-1HV07-4AX0**

###### *Upgrades*

###### **V7.4 to V7.5**

- For WinCC/Audit RT
- For WinCC/Audit RC or WinCC/ChangeControl

**6AV6371-1DV07-5BX4**  
**6AV6371-1DV17-5BX4**

###### As download

- WinCC/Audit RT
- For WinCC/Audit RC or WinCC/ChangeControl

**6AV6371-1KV07-5BX4**  
**6AV6371-1KV17-5BX4**

###### **V7.2/7.3 to V7.5**

- For WinCC/Audit RT
- For WinCC/Audit RC or WinCC/ChangeControl

**6AV6371-1DV07-5BX3**  
**6AV6371-1DV17-5BX3**

###### As download

- WinCC/Audit RT
- For WinCC/Audit RC or WinCC/ChangeControl

**6AV6371-1KV07-5BX3**  
**6AV6371-1KV17-5BX3**

###### **V7.x to V7.4 SP1**

- For WinCC/Audit RT
- For WinCC/Audit RC or WinCC/ChangeControl

**6AV6371-1DV07-4BX3**  
**6AV6371-1DV17-4BX3**

###### As download

- WinCC/Audit RT
- For WinCC/Audit RC or WinCC/ChangeControl

**6AV6371-1KV07-4BX3**  
**6AV6371-1KV17-4BX3**

##### More information

More information is available at:

<http://www.siemens.com/customized-automation>

Information on the declarations of conformity for SIMATIC WinCC can be found at:

<https://new.siemens.com/global/en/markets/pharma-industry/good-manufacturing-practice.html>

## Overview

### WinCC/Calendar Scheduler

- Option for SIMATIC WinCC for managing events in a calendar
- Setting WinCC variables or starting global scripts at defined times.

#### Licenses:

- WinCC/Calendar Scheduler comprises engineering and runtime software, with licensing either on the WinCC server or single-user system
- A common "Upgrade for WinCC Calendar options" software package is used to upgrade to a new version.

## Benefits

- Simple operation, configuration and planning of events thanks to handling in the style of Microsoft Office Calendar
- Simple configuration of the actions by parameterization (execution of WinCC scripts or writing of WinCC tags at certain times)
- Configuration of recurring events taking account of configurable public holidays, vacation periods, and maintenance periods
- Secure operation of the plant taking account of different authentication levels
- Clear representation of events at runtime by means of Calendar Runtime Control
- Flexible use in all typical WinCC plant configurations, client/server, redundant systems, WebNavigator

## Function

With the WinCC Calendar Scheduler, events and their associated actions can be configured in a user-friendly and clear way in an editor in WinCC Explorer.

The events are represented in a calendar. The period represented can be freely selected. Recurring events can be defined as serial events with any desired exceptions.

The events are displayed in a .Net control. The Calendar Scheduler is easy and intuitive to operate and supports drag & drop during configuration and runtime.

## Ordering data

### Article No.

#### WinCC/Calendar Scheduler

- WinCC V7.5
- WinCC V7.4 <sup>1)</sup>

**6AV6372-1DC07-5AX0**  
**6AV6372-1DC07-4AX0**

#### Download

- WinCC V7.5
- WinCC V7.4 <sup>1)</sup>

**6AV6372-1HC07-5AX0**  
**6AV6372-1HC07-4AX0**

#### Upgrade

- V7.4 -> V7.5
- V7.2/7.3 -> V7.5
- V7.x -> V7.4 <sup>1)</sup>

**6AV6372-1DC07-5AX4**  
**6AV6372-1DC07-5AX3**  
**6AV6372-1DC07-4AX3**

#### Download

- V7.4 -> V7.5
- V7.2/7.3 -> V7.5
- V7.x -> V7.4 <sup>1)</sup>

**6AV6372-1KC07-5AX4**  
**6AV6372-1KC07-5AX3**  
**6AV6372-1KC07-4AX3**

<sup>1)</sup> Also compatible with WinCC V7.4 SP1, except Windows Server 2016.

## More information

You can find more information at:

<http://www.siemens.com/wincc-calendar-options>

## HMI Software

### SIMATIC WinCC options

#### WinCC/Event Notifier

##### Overview

###### WinCC/Event Notifier

- Option for SIMATIC WinCC for notifying selected persons by email in specified time slots
- Notification depends on events occurring in the WinCC Alarm System
- Escalation levels, i.e. Group 2 is only notified when nobody "on site" or from Group 1 has reacted within a specified time
- Final notification of all persons previously notified in connection with the specific event about the reaction that has taken place

###### Licenses

- WinCC/Event Notifier comprises engineering and runtime software, with licensing either on the WinCC server or single-user system
- A common "Upgrade for WinCC Event Notifier options" software package is used to upgrade to a new version

##### Benefits

- Simple operation, configuration and planning of notifications thanks to handling like the Microsoft Office Calendar
- Easy configuration of the notifications including support of the WinCC Runtime languages by connecting to the WinCC alarm system
- Configuration of recurring events taking account of configurable public holidays, vacation periods and maintenance periods
- Secure operation of the plant taking account of different authentication levels
- Clear display and intuitive operation at runtime by means of Calendar Control
- Flexible use in all typical WinCC plant configurations, single station, client/server, redundant systems, WebNavigator

##### Function

The WinCC Event Notifier enables the following to be configured in a clear and user-friendly manner via the Calendar Options Editor in the WinCC Explorer:

- The e-mail service for sending and receiving messages
- The messages by selecting configured messages in the WinCC Alarm System as well the setup and contents of the message by selecting the message blocks
- Contacts by selecting predefined persons from the WinCC user administration.

In a calendar it is then possible to select the persons to be notified within the opened time slot from the existing contacts. If several persons or groups of persons are set up for the same time slot, escalation levels can be implemented by assigning different escalation times (= dead time before notification). The period represented by the calendar can be freely selected. Recurring events can be defined as serial events with any desired exceptions.

The calendar can also be integrated as .Net Control in WinCC screens; the appearance of the calendar controls at runtime is configurable. Via the calendar control, you can create time slots during runtime with contacts who should be notified upon occurrence of the configured events in the WinCC Alarm System. In addition, the calendar control allows the creation of new contacts by means of selection from the WinCC user management.

The Event Notifier is easy and intuitive to operate and supports drag & drop during configuration and runtime.

##### Ordering data

##### Article No.

###### WinCC/Event Notifier

- For WinCC 7.5
- For WinCC V7.4 <sup>1)</sup>

###### As download

- For WinCC V7.5
- For WinCC V7.4 <sup>1)</sup>

###### Upgrade

- from V7.4 -> 7.5

###### As download

- from V7.4 -> 7.5

**6AV6372-1DD07-5AX0**  
**6AV6372-1DD07-4AX0**

**6AV6372-1HD07-5AX0**  
**6AV6372-1HD07-4AX0**

**6AV6372-1DC07-5AX4**

**6AV6372-1KC07-5AX4**

<sup>1)</sup> Also compatible with WinCC V7.4 SP1, except Windows Server 2016.

##### More information

You can find more information at:

<http://www.siemens.com/wincc-calendar-options>

**Overview****WinCC/ODK (Open Development Kit)**

- WinCC option for utilization of the exposed programming interfaces that can be used to access data and functions of the WinCC configuration and WinCC runtime system
- The interfaces are designed as "C-Application Programming Interface" (C-API)
- As of WinCC version 7.2, the Open Development Kit includes the previous WinCC/IndustrialX option

**Licenses**

The scope of supply of WinCC/ODK includes many examples and comprehensive documentation.

You can find more information on the Software Update Service, license types, online software delivery and handling your licenses with the Automation License Manager here:

<http://www.siemens.com/simatic-licenses>

**Benefits**

- Individual system expansions via an open standard programming language
- Access to data and functions of the WinCC configuration and runtime system
- Development of your own applications and add-ons for the WinCC basic system

**Function**

API functions are configuration and runtime functions, such as:

- MSRTCreateMsg: Creates a message
- DMGetValue: Determines the value of a tag
- PDLRTSetProp: Sets the object properties in a display

They can be used as follows:

- Within WinCC, e.g. in global scripts or within the scope of C actions in the Graphics Designer
- In Windows applications in the C programming language (the current version of Microsoft Visual C++ is required as a developer's environment for WinCC)

**Ordering data****Article No.**

**SIMATIC WinCC/ODK**  
Open Development Kit,  
Option for SIMATIC WinCC

- V7.4 <sup>1)</sup>
- V7.3 SE

**6AV6371-1CC07-4AX0**  
**6AV6371-1CC07-3AX0**

**As download**

- V7.4 <sup>1)</sup>
- V7.3 SE

**6AV6371-1GC07-4AX0**  
**6AV6371-1GC07-3AX0**

<sup>1)</sup> Also compatible with WinCC V7.4 SP1

**More information**

You can find more information at:

<http://www.siemens.com/wincc-odk>

## HMI Software

### SIMATIC WinCC options

#### WinCC/Connectivity Pack & WinCC Connectivity Station

##### Overview

##### **WinCC/Connectivity Pack & WinCC Connectivity Station**

Cross-vendor communication in the automation sector has always been of primary importance for WinCC. This is even more true for the release of preprocessed production data for higher-level information systems (e.g. MES = Management Execution System, ERP = Enterprise Resource Planning or Office packages = MS Excel, MS Access, etc.). WinCC features integrated OPC Data Access and OPC XML DA servers for access to all online values in the system and makes open interfaces available for access to historical WinCC data.

- The Connectivity Pack includes OPC XML DA 1.00, OPC HDA 1.20 (Historical Data Access), OPC A&E 1.10 (Alarm & Events) as well as a WinCC OLE-DB interface, which also gives remote computers without installed WinCC access to WinCC archive and alarm data.
- The function of the OPC servers (XML DA, HDA and A&E) and the OPC UA servers (DA, HDA, AC) is assured by the WinCC/Connectivity Pack. In order to access data in the database via WinCC OLE-DB/OLE-DB, you will also need a license for the WinCC/Connectivity Pack.

##### Licensing:

- A Connectivity Pack license is required for each WinCC system to be accessed.
- When using the Connectivity Station it is not necessary to install additional Connectivity Pack licenses on the WinCC systems being accessed.
- The "WinCC Connectivity Station" license is required in order to utilize the OPC interfaces of the Connectivity Station on a computer without the WinCC software.
- For sole use of the OPC interfaces of a WinCC installation, only the Connectivity Pack license is required.

The following table shows the rules:

	<b>New: WinCC-independent installation at Connectivity Station</b>	<b>Conventional installation: OPC with WinCC</b>
<b>OPC DA</b>	"WinCC Connectivity Station" license	No license required
<b>OPC HDA</b>	"WinCC Connectivity Station" license	"WinCC Connectivity Pack" license
<b>OPC A&amp;E</b>	"WinCC Connectivity Station" license	"WinCC Connectivity Pack" license
<b>OPC UA DA</b>		"WinCC OPC UA HDA / AC Connectivity Pack" license

The Connectivity Station is planned over NCM PC Manager or SIMATIC Manager. In versions 7.0 and higher, the Connectivity Station does not run as a service.

You can find more information on the Software Update Service, license types, online software delivery and handling your SW licenses with the Automation License Manager here: <http://www.siemens.com/simatic-licenses>

##### **Benefits**

- Access to variables, historical WinCC data, alarm data and user archives from any computer
- Options for analyzing and evaluating process data with specialist tools or user-defined applications (e.g., via VisualBasic)

**Function**

As an OPC HDA server, WinCC makes historical data from the WinCC archive system available to other applications. An OPC HDA client (e.g. a reporting tool) can define the time interval for the required data by entering a start and end time. OPC HDA servers also support the generation of a variety of aggregate functions on the server itself (e.g. standard deviation, variance, mean values, integral values, etc.), thereby helping to relieve the load on the network, as only preprocessed data are transmitted.

OPC A&E servers are used to forward WinCC messages (along with all associated process values) to any client at production or enterprise control level. Filter mechanisms and subscriptions ensure that only selected modified data are transmitted. Acknowledgement is of course also supported.

The WinCC OPC XML DA server makes cross-platform communication between Windows and non-Windows systems possible, even via the Internet. This enables read and write WinCC online values (external and internal WinCC variables) to be exchanged with non-Siemens systems.

WinCC OLE-DB makes standardized and user-friendly access to WinCC archive data possible (MS SQL Server). In exactly the same way as access via the OPC HDA and OPC A&E interfaces, access via the WinCC OLE DB provider makes all WinCC archive data available along with the associated process values and message/user texts. The WinCC OLE-DB provider also supports analysis functions such as minimum, maximum, message hit list, etc.

The WinCC Connectivity Station was designed as a stand-alone gateway to WinCC server data. It supports access to WinCC server data over the OPC channels described as well as those for process values (not alarms) over OLE DB. Access to WinCC data is transparent, i.e. independent of which server of a redundant pair is active or whether data have already been transferred to the central archive server.

**Connectivity Station**

If no visualization is required at a station, any Windows computer with access to WinCC via OPC and OLE-DB can be configured via the Connectivity Station. This permits access to WinCC stations with server packages from a central computer without WinCC installation. The WinCC stations can be accessed via the following interfaces:

- OPC interfaces of the Connectivity Station
- OLE DB interface of the Connectivity Pack

The two access variants are autonomous access options with different ranges of functions.

OPC interfaces of the Connectivity Station

The Connectivity Station provides interfaces via which you can access the following using an OPC-Client.

- OPC-DA-Server: tags, e.g. process values
- OPC-HDA-Server: archived process values
- OPC-A&E-Server: alarms

**Ordering data****Article No.***WinCC/Connectivity Pack & WinCC/Connectivity Station***V7.5 for WinCC V7.5****Basic packages**

- WinCC/Connectivity Pack V7.5 <sup>1)</sup>
- WinCC/Connectivity Station V7.5 <sup>1)</sup>

**6AV6371-1DR07-5AX0**  
**6AV6371-1DR17-5AX0**

As download

- WinCC/Connectivity Pack V7.5
- WinCC/Connectivity Station V7.5

**6AV6371-1HR07-5AX0**  
**6AV6371-1HR17-5AX0**

**V7.4 SP1 for WinCC V7.4 SP1****Basic packages**

- WinCC/Connectivity Pack V7.4 SP1 <sup>1)</sup>
- WinCC/Connectivity Station V7.4 SP1 <sup>1)</sup>

**6AV6371-1DR07-4AX0**

**6AV6371-1DR17-4AX0**

As download

- WinCC/Connectivity Pack V7.4 SP1
- WinCC/Connectivity Station V7.4 SP1

**6AV6371-1HR07-4AX0**

**6AV6371-1HR17-4AX0**

<sup>1)</sup> Upgrades are included in the WinCC basic software upgrades

**More information**

You can find more information at:

<http://www.siemens.com/wincc-connectivity-pack>

## HMI Software

### SIMATIC WinCC options

#### SIMATIC TeleControl

##### Overview

###### **SIMATIC TeleControl**

SIMATIC TeleControl for WinCC supports connection to outlying stations (Remote Terminal Units = RTUs) via telecontrol protocols.

- SIMATIC TeleControl V7.4 has been released for use with WinCC V7.4.
- For compatibility with WinCC 7.4 SP1, use TeleControl V7.4 update 1
- SIMATIC TeleControl V7.4 supports the combination with WinCC as a Windows service

###### Licenses:

- SIMATIC TeleControl for WinCC consists of an engineering and a runtime component
- The engineering software is supplied with a floating license. The floating license allows installation of the software on any number of computers. This means one user per license can use the software independently of the computer used or a specific workstation.
- The runtime software is supplied as a single license for one server and allows a specific number of stations to be connected depending on the license.

You can find more information on the Software Update Service, license types, online software delivery and handling your SW licenses with the Automation License Manager here:

<http://www.siemens.com/simatic-licenses>

##### Benefits

SIMATIC TeleControl for WinCC V7.4 can not only integrate newly configured RTUs, but it can also integrate units which already exist in outlying areas by means of DNP3 or IEC 870-5-101/104 drivers. For communication with the outstations, SIMATIC TeleControl for WinCC V7.4 uses the SINAUT ST7 and DNP3 protocols (both via serial and TCP/IP communication connections) as well as IEC 870-5-101 (serial) and IEC 870-5-104 (Ethernet TCP/IP).

The serial RTU link is possible via the following components, which can be connected directly via WinCC (single station or server):

- SINAUT TIM communication modules (SINAUT ST7 telecontrol protocol)
- TCP/IP serial converter (telecontrol protocols DNP3, IEC 870-5-101)

Equipment from MOXA or Lantronix, for example, can be used as TCP/IP serial converters.

By means of Ethernet TCP/IP, the RTUs can be connected directly or via TCP/IP WAN routers to the SIMATIC WinCC system bus (SINAUT ST7, DNP3, IEC 870-5-104 telecontrol protocols). When using the SINAUT ST7 telecontrol protocol, the SINAUT TIM communication module can be used in addition to the TCP/IP WAN router or as an alternative.

##### Application

Telecontrol communication over the wide area network is largely determined by the communication infrastructure which already exists. Various transmission media such as dedicated line, analog or digital telephone networks, wireless networks (GSM or private), DSL or GPRS can also be combined with each other.

###### **SINAUT ST7 telecontrol protocol**

Detailed information for implementing telecontrol applications with the SINAUT ST 7 telecontrol protocol via the Industry Mall.

###### **IEC 60870-5-101/104 telecontrol protocols**

More detailed information for implementing telecontrol applications with the IEC 60870-5-101/104 telecontrol protocols via the Industry Mall.

###### **DNP3 telecontrol protocol**

SIMATIC TeleControl for WinCC V7.4 also supports the DNP3 telecontrol protocol. Widely distributed outstations (RTUs) can be controlled and monitored with the DNP3 telecontrol protocol via serial or Ethernet TCP/IP communication links by means of the telecontrol center in SIMATIC WinCC.

The control center integrated with SIMATIC TeleControl into the SCADA system is the master during telecontrol communication. The slaves are represented by the remote stations. SIMATIC S7-1200, SIMATIC S7-1500, SIMATIC Distributed Controllers ET 200SP, SIMATIC S7-300/S7-300F and S7-400/S7-400F/S7-400H/S7-400FH controllers as well as RTU3000C and third-party RTUs can be used as remote stations.

Further hardware and software components round off the range of products:

- TIM communication modules
- TCP/IP converters – serial and MD modem modules
- Mobile radio components (GSM/GPRS)
- TCP/IP routers and switches
- SCALANCE S security modules
- Dedicated line accessories
- Cables
- Engineering package for configuration of DNP3 data objects, stations, networks and connections as well as for diagnostics

In order to implement telecontrol networks, basic topologies including point-to-point, multi-point, star and ring can be configured using classic or TCP/IP-based media. These can be combined flexibly depending on the existing infrastructure.

Classic WAN media:

- Dedicated line via modem, e.g. SINAUT MD2
- Private radio networks
- Analog telephone network
- Digital ISDN network
- GSM, UMTS, LTE mobile network

TCP/IP-based WAN media:

- Ethernet networks, e.g. SCALANCE X with fiber-optic cables
- Industrial Wireless LAN with SCALANCE W
- Public networks and the Internet using DSL and/or GPRS



**Function**Special characteristics of DNP3 communication

- Change-driven data transmission
  - Change-driven transmission of process data between RTU and control center
  - Signaling of RTU, control center or connection failure
  - Automatic data updating for all communication partners involved following troubleshooting and following the startup of the RTU or control center
- Chronological processing of process data
  - Time tagging of all data frames at the place of origin allows process data to be archived by the process control system in the correct chronological order
  - The time of the DNP3 stations in the WAN can be synchronized via SIMATIC WinCC (including summertime/wintertime switchover)
- Local data storage
  - The TIM communication module can temporarily store (for several hours or even days) message frames should the connection or the communication partner fail
  - Intermediate storage of message frames of lower priority in the case of priority-controlled data transmission (with dial-up networks or quantity-dependent data transmission costs)

Operating modes

The DNP3 telecontrol protocol supports the following operating modes:

- Polling
- Polling with time slot procedure
- Multi-master polling with time slot procedure
- Spontaneous mode in dial-up networks
- Spontaneous mode in the TCP/IP-based WAN

**Integration**

Integration of SIMATIC WinCC/TeleControl for WinCC V7.4 into the WinCC SCADA system offers particular advantages for the sectors water/wastewater, as well as oil and gas, especially in the case of the following types of plant:

- Freshwater treatment and distribution
- Wastewater treatment plants
- Oil and gas pipelines and water pipes
- Oil and gas drilling fields and the associated treatment plants

In these types of plant, remote outstations such as pumping stations, valve stations or automated stations for wellheads must be integrated.

Through the support of communication protocols for RTUs such as SINAUT ST7, SIMATIC WinCC/TeleControl for WinCC V7.4 supports the following advanced communication concepts:

- Reduction in the transferred data volume by means of event-controlled communication mechanisms for alarm and measured value information.
- Time synchronization of RTUs and correct time stamping of all data in the RTU.
- Tolerance of lower bandwidth, high latency or lack of reliability of communication lines
- Prevention of data loss due to communications failure through data backup in the RTU
- Support of communication media with serial interface (dedicated lines, dial-up connections over analog telephone lines and ISDN lines), various radio devices (standard, spread spectrum modulation), microwave and GSM
- Support for TCP/IP-based WANs (Wide Area Networks) such as DSL, GPRS or Ethernet radio networks
- Support for redundant communication connections
- Expanded communication diagnostics functions for RTU communication links
- Remote programming of RTUs
- Support for different communication topologies – Point-to-point, multidrop (multistation mode) and hierarchic network structures
- High quality server redundancy scheme without data loss in the case of server failure

## HMI Software

### SIMATIC WinCC options

#### SIMATIC TeleControl

##### Integration (continued)

Through the support of communication protocols for RTUs such as IEC 60870-5 and DNP3, SIMATIC WinCC/TeleControl for WinCC V7.4 supports the following advanced communication concepts:

- Reduction in the transferred data volume by means of event-controlled communication mechanisms for alarm and measured value information.
- Time synchronization of RTUs and correct time stamping of all data in the RTU.
- Tolerance of lower bandwidth, high latency or lack of reliability of communication lines
- Prevention of data loss due to communications failure through data backup in the RTU (not all non-Siemens RTUs support this)
- Support of communication media with serial interface (dedicated lines, dial-up connections over analog telephone lines and ISDN lines), various radio devices (standard, spread spectrum modulation), microwave and GSM
- Support for TCP/IP-based WANs (Wide Area Networks) such as DSL, GPRS or Ethernet radio networks
- Support for redundant communication connections
- Expanded communication diagnostics functions for RTU communication links
- Remote programming of RTUs
- Support for different communication topologies – Point-to-point, multidrop (multistation mode) and hierarchic network structures
- High quality server redundancy scheme without data loss in the case of server failure

##### Outstations/remote terminal units

SIMATIC WinCC/TeleControl for WinCC V7.4 supports the following preferred outstations for local distributed automation:

- Controller integrated into ET 200S (IEC 870-5-101/104 telecontrol protocols); for cost-sensitive applications, up to approx. 30 I/O signals or approx. 200 data points
- Controller integrated into RTU3030C (DNP3, IEC 60870-5-104 telecontrol protocols); for very compact and energy-saving applications, up to approx. 16 I/O signals or approx. 150 data points
- S7-1200/S7-1200F controller (DNP3, IEC 60870-5-104 telecontrol protocols); up to 150 I/O signals or approx. 2 000 data points
- S7-1500 controller (IEC 60870-5-101/104 telecontrol protocols); up to 250 I/O signals or approx. 4 000 data points
- S7-300/S7-300F controller (SINAUT ST7, DNP3, IEC 60870-5-101/104 telecontrol protocols); for extremely flexible configuration, up to 100 I/O signals or approx. 2 000 data points
- S7-400/S7-400F controller (SINAUT ST7, DNP3, IEC 60870-5-101/104 telecontrol protocols); up to 500 I/O signals or approx. 5 000 data points
- Redundant S7-400H/S7-400FH controller (DNP3 and IEC 60870-5-101/104 telecontrol protocols); up to 500 I/O signals or approx. 5 000 data points
- Third-party station with the IEC 60870-5-101/104 and DNP3 telecontrol protocols (depending on type of station)
- ET 200SP / ET 200SP F Distributed Controllers (telecontrol protocols DNP3, IEC 60870-5-104); extremely flexible configuration options; number of I/O signals / data points depend of the CPU type

**Integration** (continued)

The following table provides an overview of the current options for connecting to these outstations:

Spectrum of outstations and integration versions							
Telecontrol protocol		SINAUT ST 7		DNP3		IEC 60870-5-101	IEC 60870-5-104
Type of communication		Serial	Ethernet TCP/IP	Serial	Ethernet TCP/IP	Serial	Ethernet TCP/IP
Interface		TIM 4R-IE	TCP/IP WAN router or/and TIM 4R-IE	TCP/IP serial converter	TCP/IP WAN router	TCP/IP serial converter	TCP/IP WAN router
RTU/ interface	ET 200S with integr. CPU (corresponds to S7-314)	-	-	-	-	IM 151-7 CPU or IM 151-8 PN/DP CPU as well as 1 SI module + SIPLUS RIC library	IM 151-8 PN/DP CPU + SIPLUS RIC library
	S7-1200/S7-1200F	-	CP 1243-8 IRC	-	CP 1243-1	-	CP 1243 – 1 IEC
	ET 200SP with integr. CPU CPU1510SP(F)-1PN CPU1512SP(F)-1PN	-	CP 1542SP-1 IRC	-	CP 1542SP-1 IRC	-	CP 1542SP-1 IRC
	S7-1500	TIM 1531 IRC	TIM 1531 IRC	-	-	CM PtP + SIPLUS RIC Library	SIPLUS RIC Library
	RTU3000C	-	UMTS modem integrated or external WAN router	-	UMTS modem integrated or external WAN router	-	UMTS modem integrated or external WAN router
	S7-300/S7-300F	TIM 3V-IE	TIM 3V-IE	TIM 3V-IE DNP3	TIM 3V-IE DNP3	CP 341 + SIPLUS RIC library	CP 343 + IEC on S7 or integr. PN interface + SIPLUS RIC Library
	S7-400/S7-400F	TIM 4R-IE	TIM 4R-IE	TIM 4R-IE DNP3	TIM 4R-IE DNP3	CP 441 + SIPLUS RIC library	CP 443 + SIPLUS RIC library or integrated PN interface + SIPLUS RIC library
	S7-400H/S7-400FH	-	-	TIM 4R-IE DNP3	TIM 4R-IE DNP3	ET 200M + 2 x CP 341 + SIPLUS RIC library	CP 443 + SIPLUS RIC library
Third-party station	-	-	Depends on type of station		Depends on type of station		
Dial-up lines	•	-	•	-	-	-	
Dedicated line and radio networks	•	•	•	•	•	•	
Master/slave	•	•	•	•	•	•	
Peer-to-peer	•	•	-	-	•	•	
Mesh networks	•	•	•	•	•	•	
Time tagging in RTU	•	•	•	•	•	•	
RTU time synchronization	•	•	•	•	•	•	
Data buffering in RTU	•	•	•	•	•	•	
Routing with SIMATIC PDM	•	•	-	-	-	•	
International standard	-	-	•	•	•	•	

## HMI Software

### SIMATIC WinCC options

#### SIMATIC TeleControl

##### Ordering data

###### *SIMATIC TeleControl for WinCC*

###### **SIMATIC TeleControl 7.4 for WinCC Basic Engineering**

Software package with SIMATIC Telecontrol for WinCC 7.4 engineering software, floating license for 1 user; runs with Windows 7 Ultimate and Enterprise 32/64 bit, Windows 10 LTSB 2015 (64 bit), Windows Server 2008 R2 Standard 64 bit or Windows Server 2012 R2 Standard 64 bit, electronic documentation on CD/DVD, two languages (English, German)

**Type of delivery:**

License key memory stick, certificate of license including terms and conditions, SIMATIC WinCC Data Medium Package V7.4 and CD "WinCC TeleControl Option V7.4"

**6DL5000-7AA47-0XA5**

###### **SIMATIC TeleControl V7.4 for WinCC Server Runtime**

Software package with SIMATIC Telecontrol for WinCC 7.4 engineering software, single license for 1 user; runs with Windows 7 Ultimate and Enterprise 32/64 bit, Windows 10 LTSB 2015 (64 bit), Windows Server 2008 R2 Standard 64 bit or Windows Server 2012 R2 Standard 64 bit, electronic documentation on CD/DVD, two languages (English, German)

**Type of delivery:**

License key memory stick, certificate of license including terms and conditions, SIMATIC WinCC Data Medium Package V7.4 and CD "WinCC TeleControl Option V7.4"

- 6 stations
- 12 stations
- 256 stations
- unlimited

**6DL5002-7AA47-0XA0**  
**6DL5002-7AB47-0XA0**  
**6DL5002-7AE47-0XA0**  
**6DL5002-7AF47-0XA0**

###### *Upgrades*

###### **SIMATIC TeleControl for WinCC, upgrade V7.0 to V7.4**

Upgrade package; single license for 1 installation, E-SW and documentation on DVD; license key on USB flash drive, Class A; two languages (English, German). Executable under Windows 7 Ult/Server 2008 R2/Server 2012 R2

**6DL5002-7AA47-0XE0**

##### Article No.

###### *Driver software for telecontrol protocols*

###### **TeleControl SINAUT driver**

Runtime license for a WinCC stand-alone system or WinCC Server, single license for 1 installation.

**Requirement:**

SIMATIC TeleControl 7.4 software for WinCC Server Runtime (6, 12, 256 stations)

**Type of delivery:**

License key memory stick, certificate of license including terms and conditions

**6DL5101-8AX00-0XB0**

###### **TeleControl DNP3 driver**

Runtime license for a WinCC stand-alone system or WinCC Server, single license for 1 installation.

**Requirement:**

SIMATIC TeleControl 7.4 software for WinCC Server Runtime (6, 12, 256 stations)

**Type of delivery:**

License key memory stick, certificate of license including terms and conditions

**6DL5101-8EX00-0XB0**

###### **TeleControl IEC 870-5-101/-104 driver**

Runtime license for one WinCC Single Station or one WinCC Server, single license for 1 installation

**Requirement:**

SIMATIC TeleControl 7.4 software for WinCC Server Runtime (6, 12, 256 stations)

**Type of delivery:**

License key memory stick, certificate of license including terms and conditions

**6DL5101-8CX00-0XB0**

##### More information

For an overview of the complete performance range on the Internet, visit:

Service & Support:

Germany:

<https://support.industry.siemens.com/cs/?lc=de-DE>

International:

<https://support.industry.siemens.com/cs/?lc=en-DE>

Technical Support (Hotline):

Germany:

<https://support.industry.siemens.com/My/ww/de/requests>

International:

<https://support.industry.siemens.com/My/ww/en/requests>

More information on telecontrol (RTUs):

Germany:

<http://www.siemens.de/telecontrol>

International:

<http://www.siemens.com/telecontrol>

## Overview

Whether for a single operator station, multiple operator stations or complex solutions, whether for small or large plants – SIMATIC SCADA systems will grow with your plant. Since they are scalable over the entire life cycle, existing plants can be expanded at any time.

To enable maximum integration, some SCADA options are also available for all products and in some cases all versions. This creates security of investment.

	WinCC RT Professional	WinCC V7	WinCC Open Architecture
<b>WinCC Web Navigator</b>	x	x	--
<b>WinCC WebUX</b>	x	x	--
<b>WinCC DataMonitor</b>	x	x	--
<b>WinCC IndustrialDataBridge</b>	x	x	--
<b>SIMATIC Process Historian</b>	x (cross-version)	x (cross-version)	-- <sup>1)</sup>
<b>SIMATIC Information Server</b>	x (cross-version)	x (cross-version)	x

<sup>1)</sup> SIMATIC Process Historian cannot be used with WinCC OA.

## More information

Additional information is available at:

<http://www.siemens.com/scada-options>

## HMI Software

### SCADA options

#### WinCC IndustrialDataBridge

##### Overview

###### **WinCC IndustrialDataBridge**

- The WinCC IndustrialDataBridge option uses standard interfaces in order to connect the automation world with the world of IT and to ensure a two-way information flow.
- Using the SIMATIC WinCC IndustrialDataBridge, communication links data sources and data destinations can be created by means of simple configuration/programming. The IndustrialDataBridge can either be integrated into WinCC or used as a stand-alone application (not in conjunction with WinCC).
- Its use is very flexible, due to the support of different database formats and standard interfaces. On top of this, it offers easy configuration instead of programming, which permits fast and secure deployment.
- Data sources for WinCC IndustrialDataBridge can include WinCC Runtime Professional (V13 SP1 or higher).

###### Licenses:

- WinCC/IDB basic license for 100 tags (connections between data points corresponds to one day)
- Depending on the amount of data, the number of IDB tags can be increased through additive PowerPacks
- The licenses are additive for the number of connections as of version 7.4 (countable).

You can find more information on the Software Update Service, license types, online software delivery and handling your SW licenses with the Automation License Manager here: [www.siemens.com/simatic-licenses](http://www.siemens.com/simatic-licenses)

##### Benefits

- Connection of the automation level to the IT world
- Integration of systems from different manufacturers via numerous standard interfaces (including OPC, OPC UA, OLE-DB, Office formats)
- Cost-effective and secure due to simple configuration by means of standard software without programming
- High-performance data exchange between several systems at the same time

###### Highlights:

- No programming knowledge required
- Efficient due to transmission of individual data or block transfer (">", "<", "inside where...")
- Unicode support
- Support of Asian languages (Simplified Chinese, Japanese)
- Web Navigator; support of the WinCC IndustrialDataBridge controls in WinCC images
- WinCC IndustrialDataBridge runs as a system service, as an application in connection with WinCC Runtime Professional, or as a version-independent, standalone application

##### Design

The software comprises a configuration environment and a runtime environment. The different data interfaces are integrated via software modules. In each case, one module is required as the data source and one module as the data destination. The different modules can be combined in any way.

The connections between data source and data destination are created in the configuration environment. In the runtime environment, the IndustrialDataBridge establishes the connection autonomously and transfers the data of the linked variables.

## Function

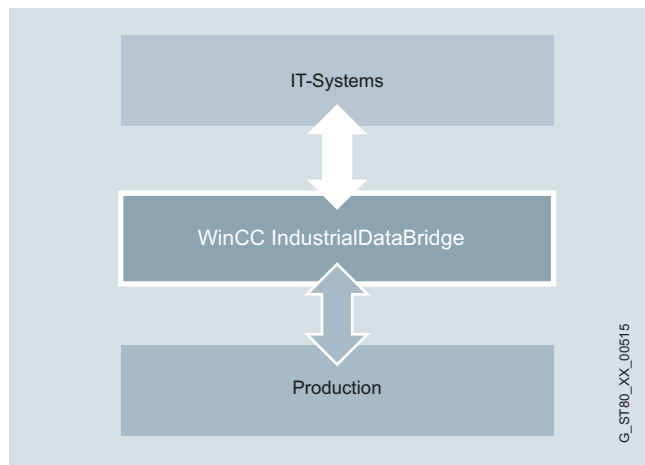

WinCC IndustrialDataBridge: Connection to databases and IT systems

- WinCC IndustrialDataBridge establishes a link between the source and destination interfaces and transfers data on the basis of a change in value once a configured period of time has elapsed, or when a defined event occurs.
- WinCC IndustrialDataBridge exchanges data between the automation systems of different manufacturers.
- In WinCC it is possible to support access to tags, tag logging, alarm logging and user archive data.
- Possible storage of process data in Office formats such as Excel or Access. Databases can also be integrated for the archiving of larger aggregates.
- One of the features of WinCC IndustrialDataBridge is a send/receive interface which also enables data transfer to SIMATIC S5 or S7-300 stations or other send/receive-compatible devices.
- WinCC IndustrialDataBridge likewise enables SCADA and control systems from a variety of manufacturers to be linked via the OPC interface. In addition, communication via RFC1006 or Send/Receive is also supported.
- SQL databases are available as data destinations for production data acquisition. Data can be transferred from the data source on an event-driven basis with the OPC module or sent directly from the PLC with the Send/Receive module.
- Integration of the WinCC IndustrialDataBridge runtime control into WinCC screens when installing the WinCC IndustrialDataBridge on a WinCC station.
- Independent text-based csv, txt and HTML files are created on reaching a programmable number of entries or if the value of a WinCC tag changes.
- Block transfer for databases through the support of the operators "<" and ">" in the Select instruction.
- Available providers (data sources) can be connected to any consumers (data targets) via the WinCC IndustrialDataBridge (see table below).

Functions for configuration:

- Graphic design of links using drag & drop
- Import and export of links
- Highlighting of selected links
- Renaming of links is possible at any time
- Fast switch for the configuration of the graphic links

Interfaces:

The table below shows the possible data sources and destinations.

Provider (data sources)	Consumer (data destinations)
<ul style="list-style-type: none"> <li>• MS Access 2003, 2007, 2010, 2013, 2016</li> <li>• MS SQL Server 2005, 2008, 2008 R2, 2012, 2014, 2016</li> <li>• MySQL 3.5, 5.1, 5.5, 5.6, 5.7</li> <li>• Oracle 8i, 10g, 11g, 12c Release 2, 12c</li> <li>• OPC Access 3.0</li> </ul>	<ul style="list-style-type: none"> <li>• MS Access 2003, 2007, 2010, 2013, 2016</li> <li>• MS SQL Server 2005, 2008, 2008 R2, 2012, 2014, 2016</li> <li>• MySQL 3.5, 5.1, 5.5, 5.6, 5.7</li> <li>• Oracle 8i, 10g, 11g, 12c Release 2, 12c</li> <li>• MS Excel 2003, 2007, 2010, 2013, 2016</li> <li>• OPC Data Access 3.0</li> <li>• OPC XML 1.01</li> <li>• IDB OPC Server</li> </ul>
<ul style="list-style-type: none"> <li>• OPC XML 1.01</li> <li>• Send/Receive</li> <li>• WinCC OLE DB 7.2, 7.3, 7.4, 7.4 SP1, 7.5</li> <li>• WinCC UserArchives 7.2, 7.3, 7.4, 7.4 SP1, 7.5</li> <li>• WinCC RT Professional V13 SP1, V13 SP2, V14 SP1, V15, V15 SP1 (via OLE DB provider)</li> </ul>	<ul style="list-style-type: none"> <li>• Send/Receive</li> <li>• WinCC User Archive 7.2, 7.3, 7.4, 7.4 SP1, 7.5</li> <li>• Configurable file editor for TXT / HTML / XML</li> <li>• CSV, TXT file</li> <li>• OPC UA DA (1.0.3) server (incl. status messages)</li> <li>• OPC UA DA (1.0.3) client</li> </ul>
<ul style="list-style-type: none"> <li>• OPC UA DA (1.0.3) client</li> </ul>	

## HMI Software

### SCADA options

#### WinCC IndustrialDataBridge

##### Ordering data

##### Article No.

###### SIMATIC WinCC IndustrialDataBridge 7.5 for WinCC

For data exchange with databases and OPC servers; language versions: English, German, Simplified Chinese, Japanese

- Basic package
- With 300 tags (countable)
- With 1 000 tags (countable)
- With 3 000 tags (countable)

6AV6362-4AA07-5AA0  
6AV6362-4AD00-0BB0  
6AV6362-4AF00-0BB0  
6AV6362-4AH00-0BB0

###### As download

- Basic package
- With 300 tags (countable)
- With 1 000 tags (countable)
- With 3 000 tags (countable)

6AV6362-4AA07-5AH0  
6AV6362-4AD00-0AH0  
6AV6362-4AF00-0AH0  
6AV6362-4AH00-0AH0

###### SIMATIC WinCC IndustrialDataBridge 7.4 SP1 for WinCC

For data exchange with databases and OPC servers; language versions: English, German, Simplified Chinese, Japanese

- Basic package
- With 300 tags (countable)
- With 1 000 tags (countable)
- With 3 000 tags (countable)

6AV6362-4AA07-4AA0  
6AV6362-4AD00-0BB0  
6AV6362-4AF00-0BB0  
6AV6362-4AH00-0BB0

###### As download

- Basic package
- With 300 tags (countable)
- With 1 000 tags (countable)
- With 3 000 tags (countable)

6AV6362-4AA07-4AH0  
6AV6362-4AD00-0AH0  
6AV6362-4AF00-0AH0  
6AV6362-4AH00-0AH0

###### SIMATIC WinCC IndustrialDataBridge upgrade

- From V7.4 to V7.5
- From V7.2/7.3 to V7.5
- From V7.x to V7.4 SP1
- From V7.x to V7.3

6AV6362-4AA07-5AE1  
6AV6362-4AA07-5AE0  
6AV6362-4AA07-4AE0  
6AV6371-1DX07-3XX3

###### As download

- From V7.4 to V7.5
- From V7.2/7.3 to V7.5
- From V7.x to V7.4 SP1
- From V7.x to V7.3

6AV6362-4AA07-5AK1  
6AV6362-4AA07-5AK0  
6AV6362-4AA07-4AK0  
6AV6371-1KX07-3XX3

##### More information

More information is available at:

<http://www.siemens.com/idb>

You can find more information on the Software Update Service, license types, online software delivery and handling your SW licenses with the Automation License Manager here: [www.siemens.com/simatic-licenses](http://www.siemens.com/simatic-licenses)



## Overview

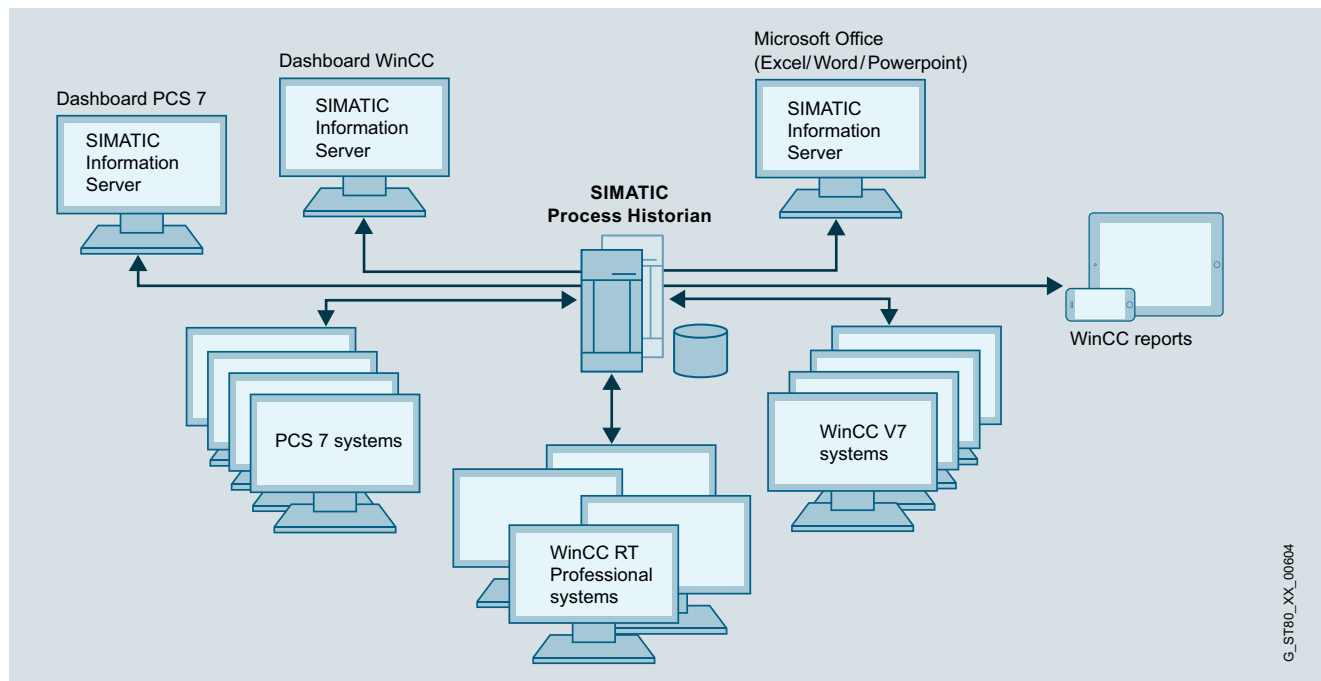

SIMATIC Process Historian

**SIMATIC Process Historian**

The Process Historian is a high-performance, long-term archiving server solution that stores WinCC process values and messages in a central database. The system offers full scalability for performance and scope: It records and stores data from one or more WinCC, WinCC RT Professional and PCS 7 projects. The number of connected single stations, servers, or redundant server pairs is unrestricted. SIMATIC Process Historian is designed for use throughout your plant, and is positioned below the corporate management level (ERP, MES).

The SIMATIC Information Server is used as a reporting system for the Process Historian. It accesses the central database of the Process Historian and visualizes the data in clear, user-friendly displays on WinCC stations or office PCs. The central Process Historian database provides access to real-time data throughout the plant.

This data is the key to sustainable plant optimization measures. Since the archive system can be fully integrated, no additional engineering is required. SIMATIC Process Historian uses the integrated relational database, SQL Server from Microsoft®. No complex reconfiguration is needed because the archive system is integrated into WinCC. Selected WinCC process values or messages are archived long-term on a time or event-driven basis.

The Process Historian is used for the long-term archiving of process values and messages.

**SIMATIC Process Historian 2014 SP3**

- Central, plant-wide long-term archive as corporate information hub
- Real-time archiving of process values and messages from WinCC V7, WinCC RT Professional and WinCC/PerformanceMonitor according to compatibility specifications
- High performance with very large data volumes
- Data access via OPC UA server
- Migration support for data migration from WinCC/Storage plus, CAS Storage plus and WinCC segments.

- High availability thanks to redundancy concept with observer/witness server for increasing data security
- High degree of security due to integrated, complete backup and restore of all segments (disaster recovery)
- Enhanced data security through store and forward mechanism
- Scalable without breaks in production
- Maximum data transparency
- High degree of security thanks to integrated backup system
- Simple and fast management and diagnostics with the Process Historian Management "Dashboard"
- Batch functionality in accordance with PCS 7 specifications

**Licenses:**

- The Basic Package includes the runtime software and the single license for one installation.
- The SIMATIC Process Historian supports archiving of any amount of data.  
The archive data is licensed at the data source, for example, in WinCC systems (archive tags for WinCC V7 or logging tags of WinCC Logging for WinCC Professional RT).
- The redundancy package is required for the redundant Process Historian; existing Basic Package installations can be converted with the redundancy option.
- The OPC UA interface needs a separate license.

You can find more information on the Software Update Service, license types, online software delivery and handling your SW licenses with the Automation License Manager here:

[www.siemens.com/simatic-licenses](http://www.siemens.com/simatic-licenses)

## HMI Software

### SCADA options

#### SIMATIC Process Historian

##### Benefits

- Fully integrated archiving solution for large volumes of data
- Central, plant-wide long-term archive as corporate information hub
- Process data and messages from any number of subordinate WinCC systems can be archived
- Plant expansions can be implemented without interrupting the production process
- High availability in redundant mode
- High degree of security due to integrated backup system
- Database for analyses with the aim of optimizing the plant and thereby raising productivity

##### Function

- Real-time storage of the WinCC archive data (process values and messages) from any number of WinCC stations
- Visualization of the archive data on WinCC clients or WinCC single stations either directly or using the SIMATIC Information Server
- Process Historian configuration tool for fast, simple engineering
- The redundant Process Historian is based on the Microsoft SQL Server Mirroring (3rd system for controlling the availability of the redundancy)
- High degree of security due to integrated complete backup and restore of all segments
- During the initial configuration the database and the segmentation are set up
- The PH-Ready component is installed on the WinCC server for the process of archiving to the PH
- The PH automatically detects all connected WinCC server projects (via the PH-Ready component)
- The Process Historian Management "Dashboard" enables simple and fast management and diagnostics

##### Ordering data

##### Article No.

###### SIMATIC Process Historian 2014 SP3

- Single License
- Single License (Redundancy Complete)  
2 x Process Historian Server  
2 x Process Historian Server Redundancy
- Single License Redundancy

6AV6361-1AA01-4AA0  
6AV6361-1BA01-4AA0

###### As download

- Single License
- Single License (Redundancy Complete)  
2 x Process Historian Server  
2 x Process Historian Server Redundancy
- Single License Redundancy

6AV6361-1AA01-4AH0  
6AV6361-1BA01-4AH0

6AV6361-1CA00-0AD0

6AV6361-1CA00-0AJ0

###### Process Historian OPC UA Server

- Standard scope of supply
- As download

6AV6361-1HA01-4AB0  
6AV6361-1HA01-4AJ0

###### Upgrades

###### Upgrade of CAS (Central Archive Server)

Upgrade of CAS V7.0 SP3 or Process Historian 2013 to Process Historian 2014 SP3

- Standard scope of supply
- As download

6AV6361-1AA01-4AE0  
6AV6361-1AA01-4AK0

###### CAS V6.x

- Upgrade from CAS V6.2 to V7.0 SP3
- Upgrade from CAS V6.2 ASIA to V7.0 SP3 ASIA

6AV6371-1DQ17-0XX3

6AV6371-1DQ17-0XV3

##### More information

More information is available at:

<http://www.siemens.com/simatic-process-historian>

You can find more information on the Software Update Service, license types, online software delivery and handling your SW licenses with the Automation License Manager:

<http://www.siemens.com/simatic-licenses>

## Overview

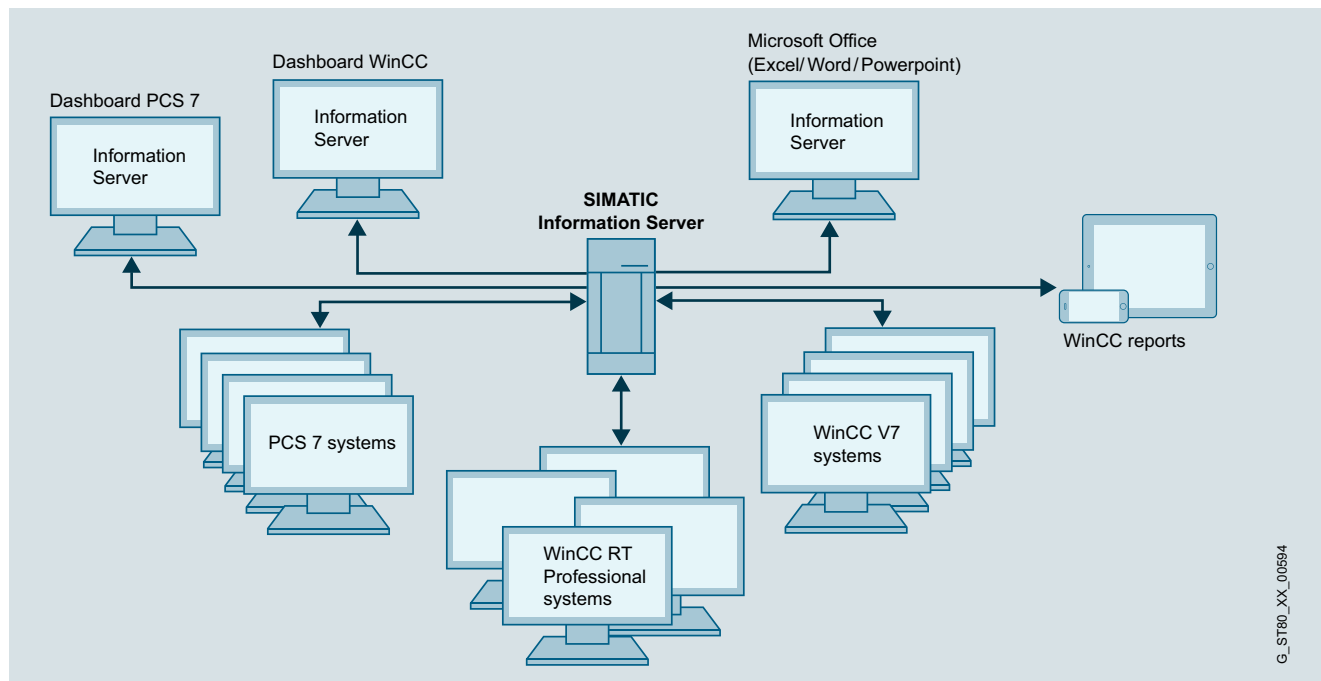

G\_ST80\_XX\_00594

**Information Server 2014 SP3**

Information Server 2014 SP3 is an open, web-based reporting system for interactive areas.

Reports can be used in Internet Explorer, Excel, Word or PowerPoint, as well as for Adobe Reader (PDF). The SIMATIC Information Server has access to archived process values and messages, and can be used either directly in conjunction with WinCC / WinCC/RT Professional / PCS7 OS as well as with Process Historian 2014 SP3.

- Access to archived process values and messages from WinCC V7, WinCC RT Professional and WinCC/PerformanceMonitor according to compatibility specifications
- Process Historian 2014 SP3
- Open reporting system with report templates in RDL or Excel format
- Through add-ins for Microsoft Office environments, direct access to the archived data of the Process Historian or WinCC can be easily established.
- Reports can be integrated directly in Word and Excel, thus greatly simplifying work steps.
- Process values can be displayed in tabular or graphic form depending on various filter functions
- Support of subscriptions for a cyclical or event-driven report generation, including sending of emails
- Web-based parameter assignment of the report templates
- Use of the standard tools MS Excel, MS Word and MS PowerPoint for individual report templates
- Reporting system based on MS Reporting Services for more complex individual report templates

- Can be used for HTML5-enabled tablet PCs larger than 10.5"
- Automatic cyclic and event-based reporting (PDF, Excel, Word, PowerPoint)
- Central storage and automatic transmission of reports created by email
- Data security thanks to access protection, user administration, SSL encryption and SMTP authentication

Licenses:

- Basic Packages include the program software as well as three client access licenses and a data source license. This gives access to one data source for up to three clients.
- The number of simultaneous client access operations can be incremented at any time using Information Server client access licenses.
- Additional data sources can be integrated at any time using additive data source licenses.

You can find more information on the Software Update Service, license types, online software delivery and handling your SW licenses with the Automation License Manager here:

[www.siemens.com/simatic-licenses](http://www.siemens.com/simatic-licenses)

## HMI Software

### SCADA options

#### SIMATIC Information Server

##### Benefits

- Central, web-based reporting system as an interface for all corporate areas up to the management level.
- Easy handling thanks to the use of standard tools such as MS Word, Excel and PowerPoint
- Provision of freely configurable reports via Web-based dashboards
- Import of data from any number of WinCC, WinCC RT Professional and PCS7 applications
- Transparent access to WinCC tag and alarm archive and to the data of the SIMATIC Process Historian

##### Highlights:

- Set of frequently used report templates for process values, messages and batches
- Open reporting system for creating any number of new report templates
- Storage of configured (parameterized) report templates for faster access
- Export of reports in common document formats
- Support of subscriptions for cyclic report generation including e-mail service
- Creation and storage of application-specific dashboards
- Role management for Windows users; supports workgroups and Active Directory; user rights can be assigned for specific projects
- Generation of reports and inserting as graphics in Microsoft Office Word documents
- Creation of Microsoft Excel, Word and PowerPoint reports for historical process values and messages as well as storage of the Excel report templates on the Information Server
- Support of subscriptions for Excel report templates
- Mobile access to reports via HTML5-enabled browser, also from tablets > 10.5"

##### Function

- Easy creation and individual design of own web pages
- No web page programming knowledge (html, asp) is necessary
- Creation of meaningful reports with Office knowledge
- Easy parameterization of predefined report templates
- Creation of your own report templates based on the Microsoft Reporting Services
- High flexibility due to access to numerous WinCC projects and the SIMATIC Process Historian
- Use of Microsoft Word and Excel for individual reports
- Consistent configuration of the access protection
- Installation-free in HTML5-enabled browsers on Web client or tablet > 10.5"

##### Ordering data

##### Article No.

###### SIMATIC Information Server 2014 SP3 "Basic Package"

- Information Server
- Information Server - Client access (3)
- Information Server - Data source access (1)

6AV6361-2AA01-4AA0

###### As download

- Information Server
- Information Server - Client access (3)
- Information Server - Data source access (1)

6AV6361-2AA01-4AH0

###### SIMATIC Information Server

Client and data source license, version-independent

- 1 Client access
- 3 Client access
- 5 Client access
- 10 Client access
- 1 Data source access
- 3 Data source access

6AV6361-2BD00-0AD0  
6AV6361-2BE00-0AD0  
6AV6361-2BF00-0AD0  
6AV6361-2BG00-0AD0  
6AV6361-2CD00-0AD0  
6AV6361-2CE00-0AD0

###### As download

- 1 Client access
- 3 Client access
- 5 Client access
- 10 Client access
- 1 Data source access
- 3 Data source access

6AV6361-2BD00-0AJ0  
6AV6361-2BE00-0AJ0  
6AV6361-2BF00-0AJ0  
6AV6361-2BG00-0AJ0  
6AV6361-2CD00-0AJ0  
6AV6361-2CE00-0AJ0

###### Upgrade

###### Upgrade Information Server 2013 to Information Server 2014 SP3

6AV6361-2AA01-4AE0

###### As download

###### Upgrade Information Server 2013 to Information Server 2014 SP3

6AV6361-2AA01-4AK0

##### More information

More information is available at:

<http://www.siemens.com/simatic-information-server>

You can find more information on the Software Update Service, license types, online software delivery and handling your SW licenses with the Automation License Manager:

<http://www.siemens.com/simatic-licenses>

## Overview

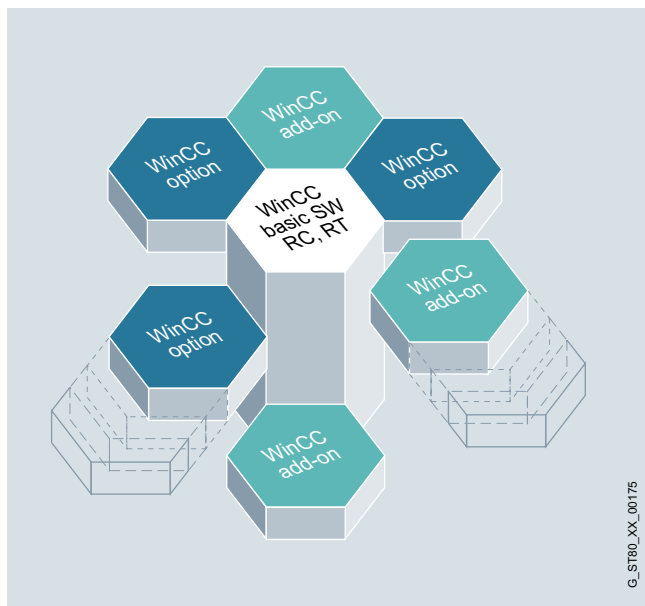
**WinCC Premium add-on – Solutions for all sectors and technologies**

The basic system is designed to be independent of any specific technology or industrial sector, to be modular and flexibly expandable and to permit not only simple single-user applications in machine construction, but also complex multi-user solutions or even distributed systems with several servers and clients in plant engineering. WinCC Premium Add-ons are supplementary products that have been created by competent partners working in the specific sectors and technologies and represent interesting expansions for WinCC.

WinCC Premium Add-ons are not DF (Siemens) products, but the products of partners who are committed to complying with certain quality features and boundary conditions. The Premium Add-ons are checked, for example, in the Siemens Test Center for their compatibility with the basic WinCC system and supported in the first instance by the central Hotline. As they are important application- and sector-specific add-on products for SIMATIC WinCC, they are marketed jointly by Siemens and the respective add-on suppliers.

The WinCC Premium Add-on products can be found on the Internet (see More information) and in the "Online WinCC Premium Add-on Catalog".

Premium Add-ons for Connectivity:

- **PM OPEN IMPORT system software**  
enables the WinCC flexible archives to be automatically read into the WinCC system.
- **PM OPEN IMPORT system software**  
offers a flexible, low-cost solution for exporting current process data and archive data from WinCC into freely structurable text files.
- **PM OPEN TCP/IP system software**  
offers a low-cost solution for connecting computer systems (PPS, laboratory, logistics and quality management systems, etc.) to the automation and process control level.
- **CONNECT ALARM Historian system software**  
permits the flexible importing of messages and alarms from WinCC and WinCC flexible into the SIMATIC IT Historian.
- **TOP Server**  
is a proven OPC data integration platform with a large number of OPC device drivers.
- **TOP Server UCON**  
enables separate OPC device drivers to be created by Point-Click configuration.

Premium Add-on for process management:

- **PM-ANALYZE**  
is used for locating sources of error or weak spots in plants by analyzing messages and process values.
- **PM CONTROL system software**  
is a cross-industry recipe system for user-friendly creation and management of recipes with integrated order control.
- **PM QUALITY system software**  
is a modular and sector-independent archive system for order-related or batch-related acquisition of process and production data.

Premium Add-on for sector products:

- **ACRON 7 for WinCC**  
is used for long-term archiving and logging of process data for small to medium-sized plants, specifically in the water supply and treatment industry.
- **Sm@rtlib function library**  
provides function blocks for S7-300/400 as well as faceplates and icons for WinCC and WinCC flexible from the areas of process industry, HVAC, pharmaceuticals and energy.

Premium Add-on for configuration tools:

- **DCC TranslationEditor**  
for the efficient, secure translation of multilingual visualizations with in-built features for quality assurance.

Premium Add-on for diagnostics and maintenance:

- **ACC Alarm Management System**  
enables messages to be passed from the visualization system to mobile radio call receivers, such as cell phones or pagers, etc.
- **PM MAINT system software**  
is a sector and technology-neutral maintenance system for use in preventive maintenance.

## HMI Software

### WinCC add-ons und partner management

#### WinCC Add-ons and partner management

##### Overview (continued)

##### **Competent partners**

With SIMATIC WinCC, you not only get excellent products to suit your requirements, but we will also support you with selecting a partner for your automation solution. In our global network of Siemens Automation Solution Providers you will always find competent partners in your neighborhood. In addition, Siemens-internal WinCC Competence Centers and WinCC Specialists support external system integrators with WinCC customer and industry-specific implementation of efficient solutions.

##### **WinCC Competence Centers**

###### Mannheim: Process management

- Sector-independent solutions and products in the fields of production, environment, maintenance and diagnostics
- Connectivity tools, system integration, connection to SAP R/3
- Support of FDA validation and WinCC ODK

###### Stuttgart: Production technology

- Solutions for maintenance management
- Alarm management

###### Plano, Texas (USA)

Migration of FactoryLink to SIMATIC WinCC

- Support for customers with migration projects
- Optimization of automated migration tools
- Support for FactoryLink customers with CSS contracts

##### More information

##### **WinCC Competence Centers**

Additional information is available on the Internet at:  
<http://www.siemens.com/wincc-coc>

##### **Siemens Solution Partners Automation**

Additional information is available on the Internet at:  
<http://www.siemens.com/automation/solutionpartner>

##### **WinCC Specialists**

Additional information is available on the Internet at:  
<http://www.siemens.com/wincc-specialists>

##### **WinCC Premium Add-ons**

Additional information is available on the Internet at:  
<http://www.siemens.com/wincc-addons>

## Overview



### SIMATIC WinCC Open Architecture

SIMATIC WinCC Open Architecture is a SCADA system for visualizing and operating processes, production flows, machines and plants in all industrial sectors.

SIMATIC WinCC OA is built consistently on object-oriented structures. Due to this consistent and well-considered use of object-oriented structures, from process images to the database, the engineering costs improve for SIMATIC WinCC OA customers.

Distributed systems enable the connection of up to 2 048 autonomous SIMATIC WinCC Open Architecture systems via a single network. Each subsystem can be configured either as single-user or multi-user system, each of which may be redundant or non-redundant.

Current version: **SIMATIC WinCC Open Architecture V3.16**

Runs on:

- Windows 10 (64-bit)
- Windows 7 Ultimate/Enterprise/Professional SP1 (64-bit)
- Windows 7 Ultimate SP1 (64-bit)
- Windows Server 2016 (64-bit)
- Windows Server 2012 R2 (64-bit)
- Red Hat Enterprise Linux 7.4 (64-bit)
- OpenSuse Leap 42.3 (64-bit)
- CentOS 7.4
  - SLES 12.1 (64-bit)
- VMWare ESXi version 6
- VMware Cluster (HA)

Note:

Native 64-bit support.

## Benefits

- Efficient engineering and flexible plant expansion
  - Object orientation
  - Unlimited number of data points
  - Mass engineering
  - Multilingual with UTF-8 support
- Object-oriented data model
  - Mapping of setpoint values and measured values for a physical plant object onto a structured data point
  - Data point comprises a tree structure with data point elements
  - The individual process values are mapped onto the data point elements
  - Any number of data points can be instanced from one defined data point structure (data point type), e.g. 20 pumps of the same type.
  - Data point types can be embedded in other data point types, which enables more complex plant objects to be generated (e.g. one pump station comprises 2 pumps).
  - Graphical plant symbols can be linked with a data point type. They only need to be drawn once, but can be used for all instances of the linked type.
  - Savings in engineering outlay.
- Freely scalable
  - From a small single-user system up to a networked, redundant high-end system
  - Distributed systems of up to 2 048 servers
- Platform-independent
  - Available for Windows, Linux, iOS and Android
- Native 64-bit support
  - More system memory is usable, due to native 64-bit support
  - This means that larger data quantity structures per server can be processed
- Maximum fail-safety and availability
  - Hot standby redundancy
  - Disaster recovery system
  - FDA compliant (FDA 21 CFR Part 11)
  - Quick and easy implementation of new processes
- Platform for customized solutions
  - Swift adaptation of the control and visualization of the plant to current market requirements
  - Company-internal programming and in-house developments enable independence and protection of intellectual property
  - Structure of standardized solutions permits continuous use
  - Support of brand-labeling
  - Individual brand names for OEM developments
- Openness thanks to comprehensive driver and interface options:
  - SIMATIC S7 TCP/IP, Modbus TCP/IP, Ethernet/IP, SNMP, BACnet, OPC DA Client & Server, OPC A&E Client & Server, OPC UA Client & Server (DA, AC, HA), SSI driver, IEC 60870-5-101, -104, DNP3, SINAUT, IEC 61850/61400, RK512, TLS, Teleperm M, API, Cerberus

## HMI Software

### SCADA System SIMATIC WinCC Open Architecture

#### SIMATIC WinCC Open Architecture

##### Benefits (continued)

- Seamless traceability of system states by means of high-performance archiving:
  - Data archiving in value archives (internal database format)
  - Data archiving in an Oracle database
- Expandable by means of add-ons and solution frameworks:
  - Add-on for integration of video management systems (VIDEO)
  - Add-ons for increasing availability (Redundancy in Hot Standby, Disaster Recovery System, etc.)
  - Add-on for clarity in distributed systems (Plant Model overview, CMS, GIS Viewer, etc.)
  - Add-ons for efficient maintenance management (Maintenance Suite, Scheduler, etc.)
  - Add-ons for mobile operability (Desktop UI, Mobile UI, ULC UX, Operator App for iOS etc.)
  - Add-ons for efficient building automation technology (BacNet, etc.)

##### Application

The SCADA system SIMATIC WinCC Open Architecture addresses applications with high demand for customer-specific adaptations, large and/or complex applications, as well as projects that demand special system requirements and functions.

SIMATIC WinCC Open Architecture demonstrates its high performance in networked and redundant high-end control systems in particular. Integrated, high-performance communication is guaranteed from the field level to the control station, from the machine to the company headquarters. In every situation, high availability, reliable information, fast interaction, and user friendliness are guaranteed.

Applications can also be changed without interrupting the process. Profitability, efficiency and safety are therefore always in equilibrium. SIMATIC WinCC Open Architecture displays its reliability in a wide range of business-critical applications.

With SIMATIC WinCC Open Architecture, ideas can be quickly and easily converted into new applications. SIMATIC WinCC Open Architecture is open for independent in-house developments and also enables own product branding.

Thanks to its special system properties, SIMATIC WinCC Open Architecture meets the highest demands especially in the case of traffic solutions, building management systems and supply systems (power, water, oil and gas, etc.).

##### Design

SIMATIC WinCC Open Architecture is available as a single-user runtime license, multi-user runtime license, Web Client license, and parameterization and development license. With SIMATIC WinCC Open Architecture the required license is determined, among other things, according to the number of inputs and outputs (I/O).

An "I/O" refers to a data point element (DPE) whose content is exchanged either by means of drivers (e.g. S7 driver communicates with a PLC), with other software systems. Internal data point elements, i.e. DPEs without communication to the outside, are not counted for licensing. The licenses are available either with an unlimited number of I/Os or with limitations of 500 to 250 000 I/Os.

The multi-user runtime license allows working simultaneously from different PCs, with the licensing taking place via the server. The active clients are then counted. The web client and the ultralight client enable the visualization and operation of process pictures over an exclusively HTTP connection between the server and the respective web client. The parameterization and development licenses extend a runtime license with the option of configuration and parameterization. They each require a server license.



**Function**

SIMATIC WinCC Open Architecture is a very modular SCADA system. The required functionalities are realized by specific, functional entities created for various tasks. In SIMATIC WinCC Open Architecture these units are called "Managers" – they are also independent processes in software terms.

WinCC OA Manager	Task
<b>Event Manager (EV)</b>	The Event Manager (EV) is the processing center in WinCC OA. This unit provides a constantly updated image of all PowerTags in the memory. Each other functional unit (Manager) that wants to access the data receives it from the process image of the Event Manager and does not have to communicate directly with a controller. Conversely, a command from an operator station is initially set only as a value change in the process image of the Event Manager. The associated driver then forwards it to the corresponding target device (e.g. PLC) automatically. The Event Manager is a kind of central data distributor, in effect the communication center for WinCC OA. Furthermore, this Manager also carries out the alarm handling and can execute various arithmetic functions autonomously.
<b>Driver Manager (D)</b>	The lowest level in a WinCC OA System is represented by the process connections, referred to in WinCC OA as drivers (D). These are special programs that handle the communication with the control and field level. Since numerous different forms of communication are possible with the PLCs or telecontrol nodes, there are different drivers that can be selected. In very simple terms, the driver is a unit for converting a particular protocol into the internal communication form of WinCC OA. The driver reads the current states, measurement or counter values from the field and in the opposite direction it forwards commands and setpoints to the lower-level controllers (= the term "control" should be used here and below to represent all possible devices of the basic automation (PLC, DDC, telecontrol system, etc.)).
<b>Data Manager (DB)</b>	The Data Manager (DB) represents the link to database. On one hand, it involves the parameterization data of an application that is to be stored in such a database. On the other hand, it involves the historical recording of changes in values or alarms. If a user wishes to query historical data at a later date, then the Data Manager completes this request and not the database itself.

WinCC OA Manager	Task
<b>Control Manager (CTRL)</b>	WinCC OA has numerous options for implementing your own algorithms and processing. The two most important are the internal language control (CTRL) and the general application programming interface (API). Control is an extremely powerful scripting language. The processing is interpretative, so that no compilation is required. The syntax is almost identical with ANSI-C, with some modifications for simplification. This is a fully developed, procedural high-level language with multi-threading (= quasi-parallel processing of individual programs; the system itself carries out the processing check). The language offers a comprehensive function library for tasks of the control and visualization technology. Control can be used as a stand-alone process (Control Manager), for animation and user interface design or for standardized, data object-oriented processing functions. The API (WinCC OA API) represents the most powerful form of functional expansion. It is configured as a C++ class library and allows the software developer to implement individual functions as an independent, additional manager (forecast system, simulation, tools, proprietary databases, etc.).
<b>User Interface Manager (UI)</b>	The interface to the user is created by the User Interface Manager (UI). This comprises a graphics editor (GEDI), a database editor (PARA) or the general user interface of the application (Vision module). The User Interface serves to display values, issue commands or track alarms in the alarm list. Trends and reports are also usually part of the UI. From a programming viewpoint, the user interaction in WinCC OA is completely isolated from the background processing – this is merely a view of the data of the current process image or the history.

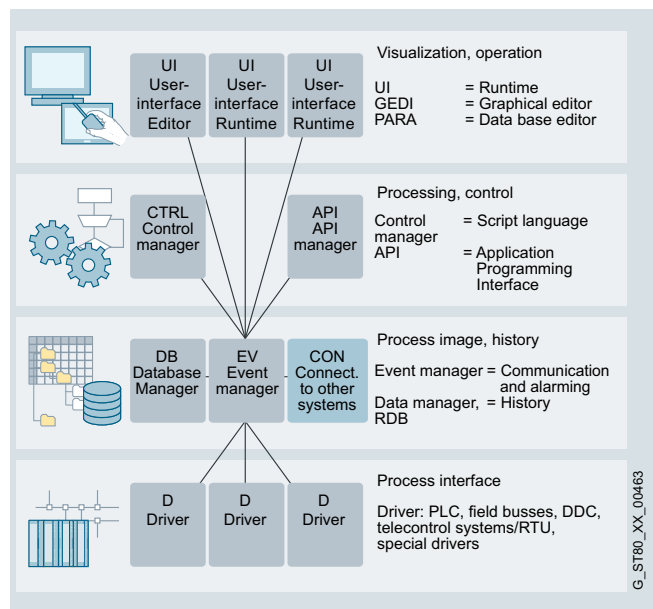

A WinCC OA System consists of function-specific units, the managers.

3

## HMI Software

### SCADA System SIMATIC WinCC Open Architecture

#### SIMATIC WinCC Open Architecture

##### Function (continued)

More managers are available for special tasks such as redundancy, management for distributed systems, web server, reporting, simulation, COM etc..

The powerful configuration functions contribute to a reduction of engineering and training overheads and lead to increased flexibility and operational reliability.

Special functions	Task
<b>Access to external databases</b>	The database interfaces offer the possibility of access to external databases. Under Windows, the link is established via the ADO Standard. ADO (ActiveX Data Objects) is an interface developed by Microsoft for vendor-independent access to data sources of all types, primarily databases. The data source for ADO is an OLE DB Provider, although ODBC-compatible databases can also be addressed via an internal wrapper. In Linux, the Qt library is used as an interface to relational databases. Access in this case is either direct via the native DB-API or via ODBC.
<b>Application Programming Interface (API)</b>	The API offers a series of functions that enable WinCC OA to be extended with special managers. A manager is a program that communicates with the system via a protocol defined by WinCC OA.
<b>COM (Component Object Model)</b>	This is a specification for the development of modular software components that can be used by each COM-compatible application. COM components can easily be integrated into such applications and can even be removed from an application during runtime. COM components can be programmed in a host of different languages, even though C++ is usually used for this purpose. The specifications OLE, ActiveX and DirectX are based on the COM technology.
<b>Control expansion</b>	Expansion that allows C++ functions to be added to the programming language.
<b>Panel topology/summation signal</b>	Generation of panel hierarchies/topologies in existing or new projects and automatic creation of summation signals of the alarm data points that are located in the panels of the topology.
<b>Redundancy (see figure below)</b>	The failure safety in a redundant system is implemented by means of hot standby. Hot standby is a hardware-independent solution for high availability. This is a safety concept that consists of two interconnected server systems. Both servers are constantly in operation and are subject to the same functional loading (but only one server is ever active; the second compares the data with the primary unit at runtime). On the failure of one unit, an "on-the-fly changeover" takes place and the previously passive server assumes the leading role. This guarantees access to data or functions at all times.

Special functions	Task
<b>Encryption of panels and CTRL scripts/libraries</b>	Allows your panels or scripts to be encrypted, thereby protecting your knowledge and work.
<b>Script Wizard</b>	Easy-to-use tool that simplifies the creation of animated, graphical plant symbols, which saves time during engineering.
<b>Simple Symbols</b>	Basic package of plant symbols that have been created using the script wizard. These can be adapted quickly and easily to the specific requirements of the customer.
<b>Easy Faceplates</b>	Simple parameter assignment of predefined pop-up windows that display details of the associated plant symbol. Without any additional drawing outlay, several standard functions per object can be activated for the detail view (alarm display, trend display, measured value table, setpoint value table, address table, notes).
<b>Drag and Draw</b>	Several representative graphical objects can be defined and configured for each plant object in the data model (data point type). These are pre-configured and need only be moved to the panel via drag-and-drop when the plant pictures are drawn. This saves valuable time during engineering.
<b>Multilingual capability</b>	Thanks to the UTF-8 format as the standard for written languages it's possible to use almost all fonts and characters in projects. Up to 40 languages can be used in any one project. User rights enable the definition of a standard language. In addition it is easy to change the display language during operation. Dictionaries can be made with a special tool or according to individual requirements.
<b>Server-side authentication</b>	Enables the connection of third-party systems including customized solutions for user authentication.
<b>Distributed systems (see the diagram below)</b>	Permits the coupling of two or more autonomous WinCC OA systems via a network. Each subsystem of a distributed system can be configured either as a single-user or multi-user system, each of which may be redundant or non-redundant. A sub-system in this context means a server on which an Event Manager is running, whereby in case of redundancy both redundantly operating servers are considered as one system.

## Integration (continued)

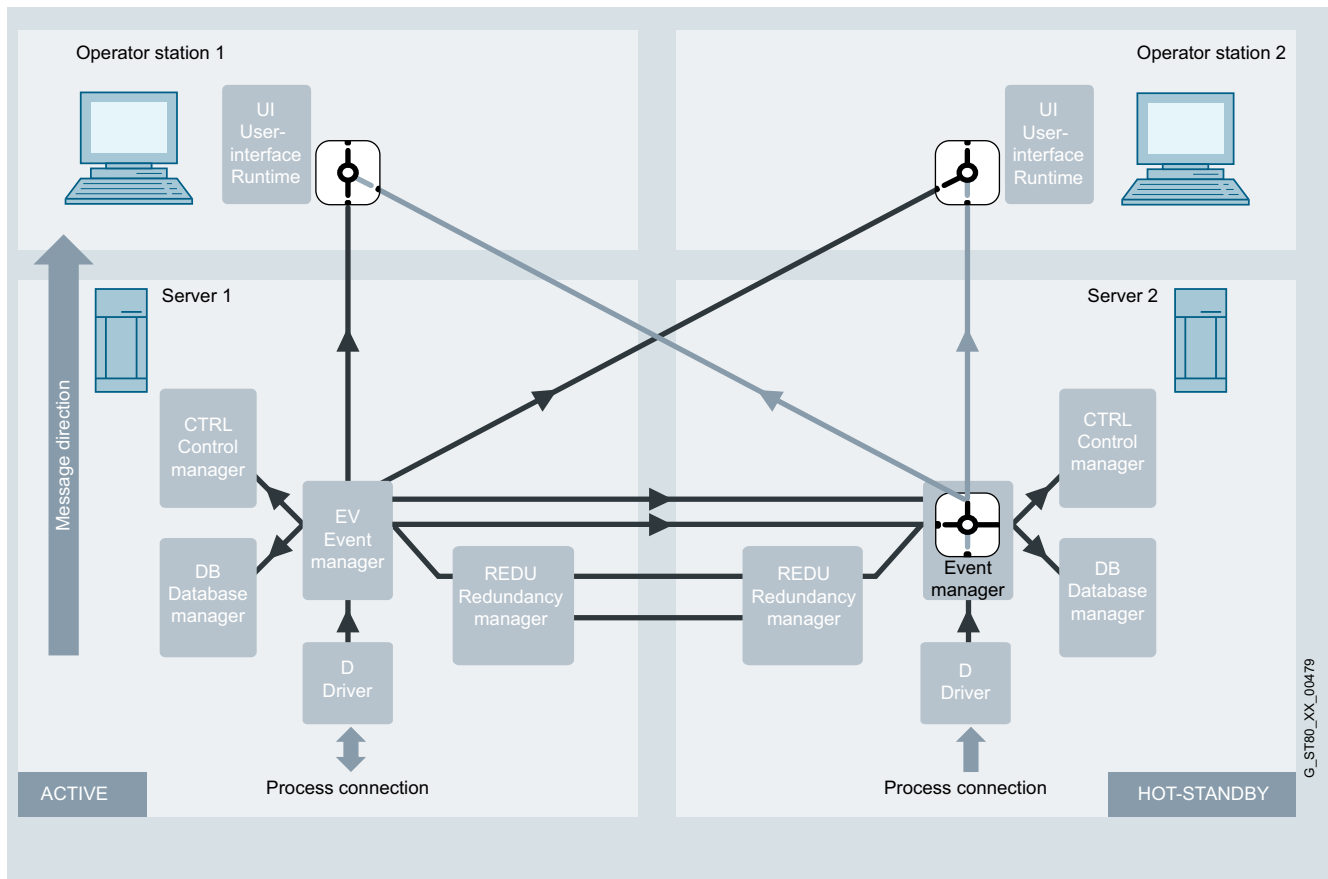

The diagram shows a detailed representation of the two computers: Server 1 and Server 2. Server 1 is in management mode (active) and Server 2 is in hot standby mode (passive). In the case of redundant operation, the UIs of both operator stations are connected to both Event Managers, however only the data of the active system is displayed on both UIs.

The Event Manager of the passive system is restricted exclusively to communication with the Event Manager of the active system for comparison of the process data (it sends no data to the connected UIs or it discards messages from the drivers – this can be seen in the figure with the switches on the UIs or on the passive Event Manager).

## Integration

**Integration in automation solutions**

SIMATIC WinCC Open Architecture is an open SCADA system with comprehensive drivers and flexible options for connection to other external systems.

Depending on the communications protocol and the bus physics used, specific drivers are used in each case:

- Serial protocols: RK512, 3964R, etc.
- Ethernet: Industrial Ethernet (S7, S7 PLUS), Modbus TCP (OpenModbus), Ethernet IP (AB), etc.
- Telecontrol systems: SINAUT, SSI (Ethernet), IEC 61850/61400, IEC 60870-5-101, IEC 60870-5-104, etc.
- Vendor-independent interfaces: OPC UA, etc.

In SIMATIC WinCC Open Architecture, several drivers can be operated in parallel.

These can be of the same type or also of different types. It is possible in a SIMATIC WinCC Open Architecture system, for example, to establish connections via the S7 protocol to a SIMATIC controller, via IEC 60870-5-104 to a telecontrol system, and via OPC DA to any OPC server at the same time.

## HMI Software

### SCADA System SIMATIC WinCC Open Architecture

#### SIMATIC WinCC Open Architecture

#### Integration (continued)

##### Connection overview

Protocol	Description
<b>S7 TCP/IP</b>	TCP/IP driver for Siemens Industrial Ethernet
<b>S7 Plus</b>	Drivers for S7 1200 and 1500 Supports alarm messages, online browsing, TIA importer for versions V13, V14 and V15
<b>OPC Client (Data Access)</b>	<ul style="list-style-type: none"> <li>• Compatibility with specifications DA 1.0 and 2.05a</li> <li>• Connection to inproc, local or remote server</li> <li>• Connection with up to 20 servers at the same time</li> <li>• Monitoring of the connection to the server and automatic reconnection if the connection is interrupted.</li> <li>• Address browsing if supported by the server.</li> <li>• Benefits of the CALL-R functionality for CALL-R servers (simplified parameter assignment)</li> </ul>
<b>OPC Server (Data Access)</b>	<ul style="list-style-type: none"> <li>• Corresponds to Data Access 2.05a specification (reading/writing of online values).</li> <li>• Is to be started as a manager just like other drivers.</li> <li>• The provided DPEs (server -&gt; client) can be easily and quickly defined via data point groups.</li> <li>• DPEs can be declared as readable (read-only access is permitted; Group OPCRead) or as writable items (Group OPCWrite).</li> <li>• Clients can browse the WinCC OA OPC Server hierarchically.</li> </ul>
<b>OPC Alarms &amp; Events</b>	OPC Alarms & Events (abbreviated to OPC A&E) is, in addition to Data Access, a further standard for performing central alarm management on a cross-vendor basis. OPC A&E is used to ensure the link to other control systems and the display of alarms/events in a hierarchical system.
<b>OPC Historical Data Access</b>	OPC Historical Data Access (OPC HDA) is used to exchange archived process data. This is in contrast to the OPC Data Access (OPC DA) specification that deals with real-time data.
<b>OPC UA (Unified Architecture)</b>	WinCC OA client supports the OPC UA Data Access (DA), Alarms & Conditions (AC) and Historical Access (HA) standards.
<b>Modbus TCP</b>	Modbus/TCP is based on the serial Modbus protocol, which was adapted for TCP/IP. The Modbus/TCP driver can be used simultaneously for Modbus/TCP or UNICOS.
<b>Ethernet/IP</b>	Ethernet/IP is used for communication with several PLC generations and families from Rockwell Automation / Allen Bradley. The protocol is part of the application layer and is based on the standard TCP/IP network protocol.
<b>Serial: RK512/3964R</b>	Is used for interfacing a PLC via the 3964R/RK512 protocol
<b>Cerberus</b>	Cerberus is a fire, intrusion and gas alarm system. The Cerberus driver guarantees communication to and from the central fire alarm systems and building security facilities in the event of a fire, gas or intruder alarm.
<b>SSI</b>	Is used for the interfacing of SAT telecontrol systems. The data is exchanged via the LAN (Ethernet, IEEE 802.3); the frame formats used are the SSI formats defined by SAT. The SK 1703 telecontrol components with a suitable communication card (KE/ET) are supported.

Protocol	Description
<b>IEC 60870-5-101, -104</b>	IEC drivers are standardized telecontrol drivers that can process proprietary frames. IEC stands for International Electrotechnical Commission, the international standardization committee for electrical engineering. <ul style="list-style-type: none"> <li>• IEC 60870-5-104 for data exchange via TCP/IP</li> <li>• IEC 60870-5-101 for serial connection</li> </ul>
<b>IEC 61850/61400</b>	IEC 61850 Client and IEC 61400 Client defines an architecture for satisfying the requirements of electrical substation automation. It defines a data model and the communication services for interaction with and between the elements of a substation, such as power supply units, circuit-breakers, protective devices etc. A description language and a system configuration language (SCL) have been defined for technical purposes.
<b>DNP3</b>	The DNP3 (Distributed Network Protocol 3) driver is an open, rugged and modern protocol which exhibits characteristics and strengths similar to the IEC driver. The transfer of any number of frames with different data types takes place between the WinCC OA system (Master) and the remote stations (Slave).
<b>SINAUT</b>	SINAUT (Siemens Network AUTomation) is a communication protocol for automated monitoring and control of remote process stations on the basis of SIMATIC S7. Communication takes place via TCP/IP.
<b>SNMP Manager &amp; Agent</b>	SNMP (Simple Network Management Protocol) is a protocol for monitoring network elements (servers, workstations, routers, switches, hubs, etc.) and their functions. <ul style="list-style-type: none"> <li>• SNMP Manager supports SNMP V1, V2, and V3</li> <li>• SNMP Agent supports SNMP V1 and V2</li> </ul>
<b>BACnet over IP – driver</b>	BACnet (Building Automation and Control Networks) is a standardized protocol for building automation and has been set by the ASHRAE (American Society of Heating, Refrigerating and Air-conditioning Engineers) as a guideline to provide a uniform and cross-company standard for data communication within and between building automation systems.  The BACnet Standard 2004 is supported in accordance with the PIC list (see product documentation)
<b>S-bus</b>	The WinCC OA S-bus driver is used to link SAIA PCD control devices to WinCC OA projects. Client mode of the SAIA S-Bus driver is used. Communication is carried out using the UDP; the serial version of the protocol is not supported.

Further drivers on request or via C++ API

### Technical specifications

Type	SIMATIC WinCC Open Architecture V3.16
<b>Operating system</b>	<ul style="list-style-type: none"> <li>Windows 10 (64-bit)</li> <li>Windows 7 Ultimate/Enterprise/Professional SP1 (64-bit)</li> <li>Windows 7 Ultimate SP1 (64-bit)</li> <li>Windows Server 2016 (64-bit)</li> <li>Windows Server 2012 R2 (64-bit)</li> <li>Red Hat Enterprise Linux 7.4 (64-bit)</li> <li>SLES 12.1 (64-bit)</li> <li>VMWare ESXi version 6</li> <li>VMware Cluster (HA)</li> <li>OpenSuse Leap 42 (64-bit)               <ul style="list-style-type: none"> <li>- CentOS 7.4</li> </ul> </li> <li>SLES 12.1 (64-bit)</li> <li>VMWare ESXi version 6</li> <li>VMware Cluster (HA)</li> </ul>
<b>Mobile operating system</b>	<ul style="list-style-type: none"> <li>Android 4.4 and higher</li> <li>iOS 11.0 and higher</li> </ul>
<b>PC hardware requirements <sup>1)</sup></b>	
<b>Processor type</b>	Intel Pentium or equivalent
Minimum	Intel Pentium IV 1.6 GHz (or better) <sup>2)3)</sup>
Recommended	<ul style="list-style-type: none"> <li>Client: Intel Pentium IV/Core2/i3, 2 GHz <sup>2)3)</sup></li> <li>Server: Intel Core i3 CPU Dual, 3 GHz <sup>2)</sup></li> <li>Server large system<sup>4)</sup>: Intel(R) Core(TM) i5/i7 CPU Dual / Quad, 3 GHz <sup>2)3)</sup></li> </ul>
<b>Work memory RAM</b>	
Minimum	2 GB <sup>2)</sup>
Recommended	<ul style="list-style-type: none"> <li>Client: 2 GB <sup>2)3)</sup></li> <li>Server: 8 GB <sup>2)3)</sup></li> <li>Server large system: 16 GB <sup>2)</sup></li> </ul>
<b>Hard disk (available memory for installation)</b>	
Minimum	HD with 800 MB available <sup>2)</sup>
Recommended	Server large system with local logging: SCSI LVD Controller, WIDE SCSI / LVD HDD or comparable storage system with at least 500 MB of available space <sup>2)</sup>
<b>Screen and graphics card (TrueColor)</b>	
Minimum	1024 x 768 <sup>2)</sup>
Recommended	1280 x 1024 <sup>2)</sup>
<b>Mouse and keyboard</b>	Mouse, keyboard
<b>DVD drive</b>	Possible for software installation, also via web installation or USB flash drive
<b>Local power user rights</b>	<ul style="list-style-type: none"> <li>For installation</li> <li>For operation</li> </ul>

- <sup>1)</sup> For actual use in plants, the hardware requirements are largely dependent on the project size and the dynamic response of the process variables. Whenever possible, use rugged, high-quality hardware with corresponding functionalities such as redundant power supply units or RAID hard disks. WinCC OA supports dual and multi-processor mode and benefits significantly from the fact that each WinCC OA Manager can be assigned to one processor core as a system process. At the same time, however, it is important that the individual cores offer the highest possible performance (high clocking), since load-critical core processes such as the event manager run on exactly one core (for this reason, multi-core machines with low-clocked cores are unsuitable for WinCC OA). As for RAM, CPU and HDD, the usual rule applies: more is better
- <sup>2)</sup> System requirements generally only refer to WinCC OA Version 3.16 under the supported versions of the Windows and Linux operating systems.
- <sup>3)</sup> A precondition for the minimum requirement is that the operating system used does not have any greater requirements itself
- <sup>4)</sup> With a large system it is essential that the system permits not only the highest data point numbers but also a high dynamic response.

WinCC OA is ideally suited for use in very large distributed systems. The optimum design of such systems demands corresponding system knowledge of WinCC OA. Due to the event-oriented processing, individual design parameters can be increased or reduced as necessary in actual applications.

Type	SIMATIC WinCC Open Architecture
<b>Functionality/quantity structure</b>	
Number of messages	150 000 <sup>6)</sup>
Message text (number of characters)	System-limited <sup>5)</sup>
Message archive	System-limited <sup>5)</sup>
Process values per message	1 process value + up to 32 alarm associated values per message
Constant load of messages, max.	500/s <sup>6)</sup>
Message burst, max.	15 000/10 s every 5 min <sup>6)</sup>
<b>Archives</b>	
Archive data points	Max. 250 000 per server <sup>6)</sup>
Archive types	< 20 parallel logs, different retention period for each log
Data storage format	Oracle or file system
Measured values per second, max.	Server/single-user station: 7 000/s <sup>6) 7)</sup>
<b>User archive</b>	
Archive	System-limited <sup>5)</sup>
Type	SIMATIC WinCC Open Architecture
Table size	System-limited by ORACLE database
<b>Graphics system</b>	
Number of screens	System-limited <sup>5)</sup>
Number of objects per screen	System-limited <sup>5)</sup>
Number of controllable fields per screen	System-limited <sup>5)</sup>
PowerTags	< 750 000 per server <sup>6)</sup>
<b>User administration</b>	
User accounts	< 4096
Configuration languages	3 (en, de, ru)
Runtime languages	40 (of which 8 Asian)
<b>Multi-user system</b>	
Server	< 2 048 <sup>6) 8)</sup>
Number of clients	< 244 per server <sup>6) 9)</sup>

- <sup>5)</sup> Dependent on the available storage space
- <sup>6)</sup> Dependent on the system configuration and the system load (due to the event-oriented architecture, the system load is essentially determined by the change rates of the values to be processed)
- <sup>7)</sup> By means of high-performance hardware configuration (one archiving cluster and approx. 120 distributed systems that archive parallel values in the cluster): 200 000 archived value changes per second
- <sup>8)</sup> Physical limit: < 2 048, in practice systems have already been implemented with up to 550 distributed systems
- <sup>9)</sup> Physical limit: < 244 clients per server, recommended: max. 100 clients per server

## HMI Software

### SCADA System SIMATIC WinCC Open Architecture

#### SIMATIC WinCC Open Architecture

#### Ordering data

##### *SIMATIC WinCC Open Architecture system software V3.16*

##### **WinCC OA core components** **WinCC OA Server**

Language/script versions:  
en, de, ru;  
with license for:

##### **WinCC OA single-user station** **500 I/O**

License for single operator station with up to 500 I/O (bit, integer), alerting, extended trend, historical recording, S7 and S7 Plus (8 connections) drivers, SSL encryption, OPC client, OPC server, OPC UA client, WinCC OA Web server and one WinCC OA OPERATOR 1 Device License. Cannot be expanded with multiple operator stations or add-ons.

##### **WinCC OA Server I/O**

License for server (without operator station licenses), alerting, extended trend, historical recordings, S7 and S7 Plus (8 connections) drivers, SSL encryption, OPC client, OPC server, OPC UA client, WinCC OA Web server and one WinCC OA OPERATOR 1 Device License.

##### • **1 000 I/O**

With a max. of 1 000 I/O of any type

##### • **3 000 I/O**

With a max. of 3 000 I/O of any type

##### • **5 000 I/O**

With a max. of 5 000 I/O of any type

##### • **10 000 I/O**

With a max. of 10 000 I/O of any type

##### • **15 000 I/O**

With a max. of 15 000 I/O of any type

##### • **25 000 I/O**

With a max. of 25 000 I/O of any type

##### • **50 000 I/O**

With a max. of 50 000 I/O of any type

##### • **75 000 I/O**

With a max. of 75 000 I/O of any type

##### • **100 000 I/O**

With a max. of 100 000 I/O of any type

##### • **150 000 I/O**

With a max. of 150 000 I/O of any type

##### • **200 000 I/O**

With a max. of 200 000 I/O of any type

##### • **250 000 I/O**

With a max. of 250 000 I/O of any type

##### • With unlimited I/O

##### **WinCC OA dongle**

Hardware dongle for USB port for operation with a hardware-independent license attached to the dongle, which can also extend the hardware-linked license of the operator station or server on a temporary basis.

#### Article No.

6AV6351-1HA31-6AA0

6AV6351-1HB31-6AA0

6AV6351-1HC31-6AA0

6AV6351-1HD31-6AA0

6AV6351-1HE31-6AA0

6AV6351-1HF31-6AA0

6AV6351-1HG31-6AA0

6AV6351-1HH31-6AA0

6AV6351-1HJ31-6AA0

6AV6351-1HK31-6AA0

6AV6351-1HL31-6AA0

6AV6351-1HM31-6AA0

6AV6351-1HN31-6AA0

6AV6351-1HP31-6AA0

6AV6351-1AH31-6AA0

#### Article No.

##### **WinCC OA on data medium**

WinCC OA Software DVD – current version on disk

6AV6351-1AX31-6AA0

##### **WinCC OA for Nanobox**

Runtime License for SIMATIC Nanobox (Win 7 Ultimate SP1 64-bit) with max. 128 I/O, including one operator station, distributed systems option, S7 and S7 Plus (8 connections) drivers, SSL encryption, OPC client, OPC server, OPC UA client, RDB option, WinCC OA Web server as well as a choice of one other driver. This package cannot be expanded with other WinCC OA options. The use of this license is exclusively restricted to the approved Nanoboxes (restrictions on the hardware side can be viewed in the online help).

- 128 I/O
- 512 I/O
- 2 048
- 4 096 I/O

6AV6351-1KA31-6AA0  
6AV6351-1KB31-6AA0  
6AV6351-1KC31-6AA0  
6AV6351-1KE31-6AA0

##### **WinCC OA Desktop UI**

Operator station license with all server operator station functionalities. Only the number of simultaneously active Desktop UIs is counted

- 1 Operator station license
- 10 Operator station licenses
- 25 Operator station licenses
- 50 Operator station licenses
- 100 Operator station licenses

6AV6351-1CP31-6AA0  
6AV6351-1CQ31-6AA0  
6AV6351-1CR31-6AA0  
6AV6351-1CS31-6AA0  
6AV6351-1CT31-6AA0

##### **WinCC OA Ultralight UX**

The Ultralight UX enables an operator station to be implemented in a web browser without installation of a plug-in. The Ultralight UX can run on PCs and laptops. Only the number of simultaneously active Ultralight UX Clients is counted. Please note Ultralight UX Client restrictions according to the online help.

- License for 1 client
- License for 10 clients
- License for 25 clients
- License for 50 clients
- License for 100 clients

6AV6351-1JK31-6AA0  
6AV6351-1JL31-6AA0  
6AV6351-1JM31-6AA0  
6AV6351-1JN31-6AA0  
6AV6351-1JP31-6AA0

##### **WinCC OA Mobile UI**

The Mobile UI enables an operator station to be implemented on a mobile device. Installation takes place via an app available in the iTunes App Store or in Google Play Store. Only the number of simultaneously active Mobile UIs is counted. You can find the supported Android and iOS devices and restrictions in the online help.

- License for 1 mobile UI
- License for 10 mobile UIs
- License for 25 mobile UIs
- License for 50 mobile UIs
- License for 100 mobile UIs

6AV6351-1JQ31-6AA0  
6AV6351-1JR31-6AA0  
6AV6351-1JS31-6AA0  
6AV6351-1JT31-6AA0  
6AV6351-1JU31-6AA0

Ordering data	Article No.	Article No.
<p><b>WinCC OA OPERATOR mobile app</b></p> <p>Permits operation and visualization of a WinCC OA installation via iPhone and iPad. Over a secured SSL connection, measured values and alarms can be retrieved, as well as commands and acknowledgements sent. Navigation takes place in list form or map-supported. The configuration is carried out in an intuitive wizard. Each device must be assigned its own, fixed license.</p> <ul style="list-style-type: none"> <li>• License for 1 device</li> <li>• License for 3 devices</li> <li>• License for 10 devices</li> <li>• License for 25 devices</li> <li>• License for 50 devices</li> </ul>	<p><b>6AV6352-1DK31-6AA0</b></p> <p><b>6AV6352-1DL31-6AA0</b></p> <p><b>6AV6352-1DM31-6AA0</b></p> <p><b>6AV6352-1DN31-6AA0</b></p> <p><b>6AV6352-1DP31-6AA0</b></p>	<p><b>WinCC OA Custom Driver</b></p> <p>6AV6351-1EL31-6AA0</p> <p>Extends a WinCC OA server license with the option of communication with a customer-specific driver. One license is required for each customer-specific driver.</p>
<p><b>WinCC OA parameter assignment and development license</b></p> <p>Client, parameterization and development license for single operator station, graphic editor with symbol catalog, user-friendly script development language, alerting, extended trend, and historical recording.</p>	<p><b>6AV6351-1EA31-6AA0</b></p>	<p><b>WinCC OA Custom Manager</b></p> <p>6AV6351-1EM31-6AA0</p> <p>Extends a WinCC OA server license with the option of communicating with a customer-specific manager. One license is required for each customer-specific manager</p>
<p><b>WinCC OA Para for single-user station</b></p> <p>Requires a corresponding single-user station license.</p>	<p><b>6AV6351-1EP31-6AA0</b></p>	<p><b>WinCC OA redundancy</b></p> <p>6AV6351-1FP31-6AA0</p> <p>Extends a WinCC OA Server with the option of bumpless switchover to a hot standby server.</p>
<p><b>WinCC OA Para</b></p> <p>Requires corresponding server license.</p>	<p><b>6AV6351-1EQ31-6AA0</b></p>	<p><b>WinCC OA distributed systems</b></p> <p>Enables the connection of several autonomous WinCC OA systems. Each server requires one server license and one distributed systems option. In the case of redundant servers, 2 licenses are required for the redundant server pair.</p>
<p><b>WinCC OA Para Remote</b></p> <p>Client, parameterization and development license for remote access to server.</p>	<p><b>6AV6351-1EK31-6AA0</b></p>	<p><b>WinCC OA distributed systems</b></p> <p>6AV6351-1GP31-6AA0</p> <p>Extends a WinCC OA Server to include the Multiserver option.</p>
<p><b>WinCC OA API interface gen.</b></p> <p>Application programming interface for the integration of customer-specific managers or drivers. One license is required for each development workstation. We strongly recommend the participation in a Certified WinCC OA Developer Workshop when ordering this product for the first time.</p>		<p><b>WinCC OA Disaster Recovery System</b></p> <p>6AV6352-1AA31-6AA0</p> <p><b>WinCC OA Disaster Recovery Center</b></p> <p>Allows configuration of a remote backup control center. A disaster recovery center comprises two distributed systems. Both systems must be redundant. Requires Oracle databases and RDB. Refer to the online help for example configurations. Each server in the Disaster Recovery System requires one WinCC OA Disaster Recovery Center option.</p>

## HMI Software

### SCADA System SIMATIC WinCC Open Architecture

#### SIMATIC WinCC Open Architecture

Ordering data	Article No.	Article No.
<b>SIMATIC WinCC Open Architecture V3.16 Communication</b>		
<b>WinCC OA TLS Gateway</b> Gateway acc. to TLS regulations via TCP/IP	6AV6352-1CN31-6AA0	<b>6AV6352-1BV31-6AA0</b>
<b>WinCC OA Teleperm M</b> Driver for Teleperm M Bus C275 (requires an Ako-Tec Bridge)	6AV6352-1BB31-6AA0	
<b>WinCC OA S7 Plus TCP/IP</b> S7 Plus driver for the new S7-1200, S7-1500 controllers, open controllers and PLC Sim, supports symbolic addressing, all protection levels and browsing of TIA Portal projects		
<ul style="list-style-type: none"> <li>• 8 connections</li> <li>• 64 connections</li> <li>• 512 connections</li> </ul>	6AV6352-1CP31-6AA0 6AV6352-1CQ31-6AA0 6AV6352-1CR31-6AA0	
<b>WinCC OA S7 TCP/IP driver</b> TCP/IP driver for Siemens Industrial Ethernet.	6AV6352-1BC31-6AA0	
<b>WinCC OA Modbus TCP/IP driver</b> Driver for Modbus TCP/IP	6AV6352-1BD31-6AA0	
<b>WinCC OA Modbus TCP/IP Server</b> The WinCC OA Modbus/TCP server allows Modbus/TC-clients to query and represent data from a WinCC OA system within the Modbus data model.	6AV6352-1CS31-6AA0	
<b>WinCC OA Ethernet/IP</b> Driver for Allen Bradley - Rockwell EtherNet/IP	6AV6352-1CK31-6AA0	
<b>WinCC OA SAIA S-Bus</b> Driver for SAIA controllers (SAIA S bus)	6AV6352-1BW31-6AA0	
<b>WinCC OA SSI driver</b> Driver for SAT telecontrol components	6AV6352-1BF31-6AA0	
<b>WinCC OA SNMP</b> Driver SNMP – network monitoring (V2&V3)	6AV6352-1BG31-6AA0	
<b>WinCC OA BACnet Driver + Diagnostics</b> Extends a WinCC OA Server to include a license for using the WinCC OA BACnet online engineering environment consisting of WinCC OA BACnet driver, WinCC OA BACnet object library including faceplates, and WinCC OA BACnet browser (max. 5 000 objects per server).	6AV6352-1DA31-6AA0	
<b>WinCC OA IEC 104</b> Driver IEC 60870-5-104	6AV6352-1BH31-6AA0	
<b>WinCC OA IEC 101</b> Driver IEC 60870-5-101	6AV6352-1BJ31-6AA0	
<b>WinCC OA IEC 61850/61400</b> Expands a WinCC OA Server with a license for using the IEC 61850 protocol comprising the IEC 61850 driver (client in accordance with IEC 61850 Standard Part 7 & Part 8 Edition 2 & IEC 61400-25) and the IEC 61850 browser.		
<b>WinCC OA DNP3</b> Driver DNP3 for connecting DNP3 devices		
<ul style="list-style-type: none"> <li>• 10 DNP3 devices</li> <li>• 25 DNP3 devices</li> <li>• 50 DNP3 devices</li> <li>• 250 DNP3 devices</li> <li>• Unlimited</li> </ul>		6AV6352-1BK31-6AA0 6AV6352-1BL31-6AA0 6AV6352-1BM31-6AA0 6AV6352-1BN31-6AA0 6AV6352-1BP31-6AA0
<b>WinCC OA SINAUT</b> Driver SINAUT for connecting controllers; For connecting a maximum of		
<ul style="list-style-type: none"> <li>• 10 controllers</li> <li>• 25 controllers</li> <li>• 50 controllers</li> <li>• 250 controllers</li> <li>• unlimited license</li> </ul>		6AV6352-1BQ31-6AA0 6AV6352-1BR31-6AA0 6AV6352-1BS31-6AA0 6AV6352-1BT31-6AA0 6AV6352-1BU31-6AA0
<b>WinCC OA RK512</b> Driver for connection via 3964R / RK512 protocol		6AV6352-1CA31-6AA0
<b>WinCC OA Cerberus</b> Driver for connection with the Siemens DMS7000 / Cerberus fire alarm system. Communication is implemented via the C-Bus (Cer-Ban) using the serial interface RS 232 (MK 7022).		6AV6352-1CH31-6AA0
<b>WinCC OA OPC HDA server</b> The WinCC OA OPC Historical Data Access (HDA) Server provides archived process data from a WinCC OA project. (Status version: "OPC HDA 1.20" (mandatory functions))		6AV6352-1CL31-6AA0
<b>WinCC OA OPC HDA Client</b> The WinCC OA OPC Historical Data Access (HDA) Client allows access to the process data provided by any OPC HDA Servers (Version: "OPC HDA 1.20" (mandatory functions))		6AV6352-1CM31-6AA0
<b>WinCC OA OPC UA Server</b> The WinCC OA OPC UA server allows OPC UA clients to query the data of a WinCC OA system. Version: "OPC UA Server 1.03" (mandatory functions).		6AV6352-1CJ31-6AA0

More information is available on the Internet at:

<http://www.siemens.com/wincc-open-architecture>



## Overview

SIMATIC WinCC Open Architecture is a SCADA system for visualizing and operating processes, production flows, machines and plants in all industrial sectors.

SIMATIC WinCC OA is built consistently on object-oriented structures. Due to this consistent and well-considered use of object-oriented structures, from process images to the database, the engineering costs improve for SIMATIC WinCC OA customers.

Distributed systems enable the connection of up to 2 048 autonomous SIMATIC WinCC Open Architecture systems via a single network. Each subsystem can be configured either as single-user or multi-user system, each of which may be redundant or non-redundant.

Current version: **SIMATIC WinCC Open Architecture V3.16**  
Runs under:

- Windows 10 (64-bit)
- Windows 7 Ultimate/Enterprise/Professional SP1 (64-bit)
- Windows 7 Ultimate SP1 (64-bit)
- Windows Server 2016 R2 (64-bit)
- Windows Server 2012 R2 (64-bit)
- Red Hat Enterprise Linux 7.4 (64-bit)
- OpenSuse Leap 42.3 (64-bit)
- CentOS 7.4
  - SLES 12.1 (64-bit)
- VMWare ESXi version 6
- VMWare Cluster (HA)

Note:

Native 64-bit support.

## Function

### SIMATIC WinCC Open Architecture add-ons

The universal WinCC Open Architecture basic software is the basis for modular expansions.

These functional expansions are available in the form of WinCC Open Architecture add-ons.

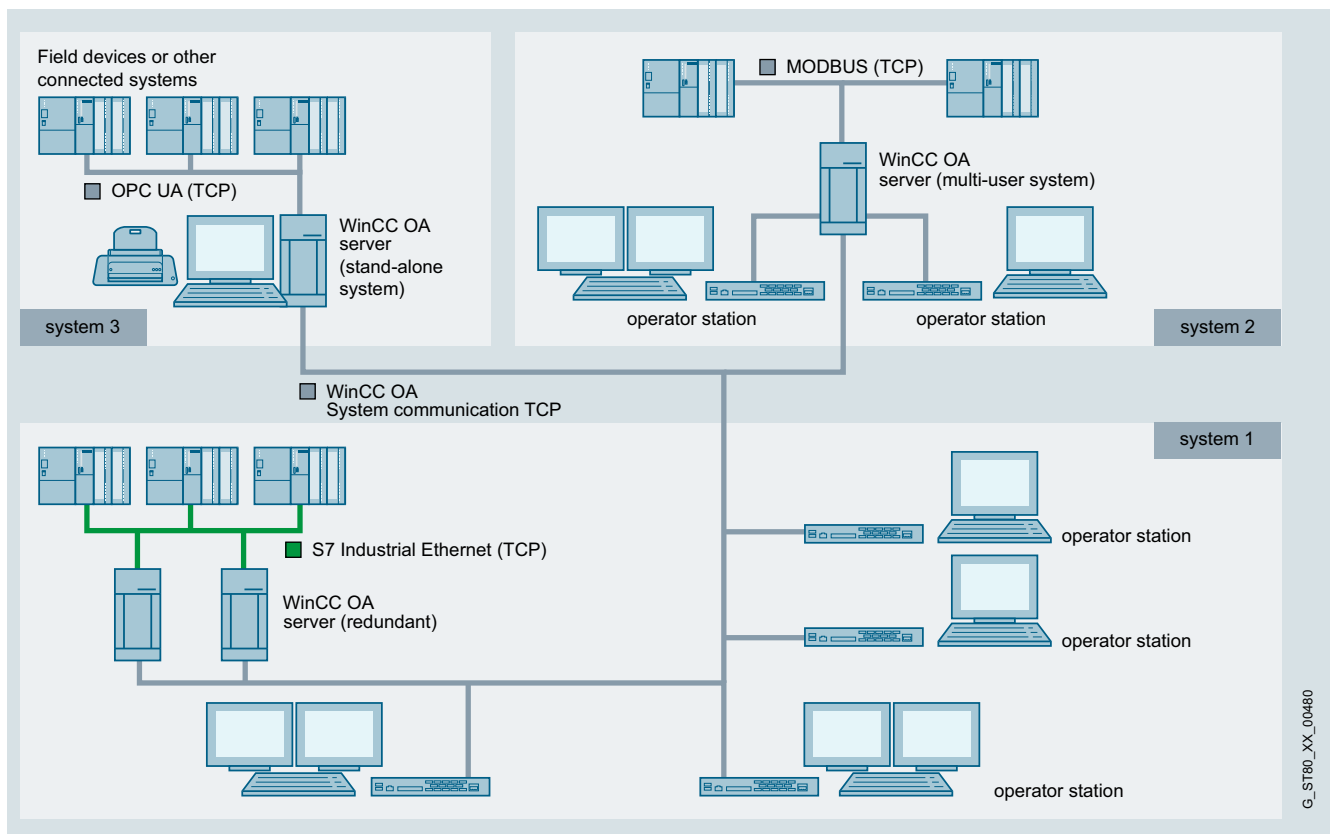

Distributed systems with WinCC OA

## HMI Software

### SCADA System SIMATIC WinCC Open Architecture

#### SIMATIC WinCC Open Architecture add-ons

##### Function (continued)

Add-ons	Task
<b>BACnet</b>	BACnet provides an integrated BACnet-compliant online/offline engineering solution for building automation technology, including object library. Designed for heating, ventilation and air-conditioning, lighting control and safety systems.
<b>S7 AdvancedLib object library</b>	The S7 AdvancedLib (AdvS7) is an industry-independent object library that permits the use and visualization of objects from the process control system (e.g.: drives, valves, regulators, motors, etc.) in a project with WinCC OA and S7. In addition to the WinCC OA and AdvS7 license, the use of S7 AdvancedLib requires the use of the relevant library on the SIMATIC side.
<b>Maintenance package</b>	Includes the following functions: Operating hours counter, operating cycle counter and maintenance log.
<b>Scheduler</b>	Permits the creation, parameterization and management of time programs that allow the time and event-driven triggering of specific actions.
<b>Recipes</b>	WinCC OA recipes allow setpoints or commands for certain data point elements to be sent simultaneously. Based on "recipe types", which define the quantity of the assigned data point elements, recipes are created that send their values to the data point elements upon activation.
<b>GIS Viewer</b>	With the help of this viewer, standardized cards of a geo-information system (GIS) can be fully integrated in WinCC OA. Furthermore, it is possible to display all WinCC OA objects in the cards.
<b>Reporting</b>	<p>Web-based reporting is implemented using the standardized Simple Object Access Protocol (SOAP) reporting interface. Reporting tools from third-party suppliers can thus be used with no additional effort. The BIRT templates that are also provided, as well as the predefined reporting data, further simplify the reporting.</p> <ul style="list-style-type: none"> <li>• Web-capable reporting interface (SOAP): <ul style="list-style-type: none"> <li>- ECLIPSE BIRT (large number of reporting templates for ECLIPSE BIRT are also supplied)</li> <li>- Crystal Reports</li> <li>- SIMATIC Information Server</li> <li>- Microsoft Excel</li> </ul> </li> <li>• Online values, history</li> <li>• Support of compressed data, SQL, alarms</li> <li>• Diagnostic tools</li> <li>• Audit trail</li> </ul>
<b>Excel report</b>	Powerful report generator directly in Microsoft Excel. Templates can be created easily and directly in Excel. If a report has to be created over a defined period of time, the system accesses the template and automatically completes it with data from the WinCC OA process database. Reports can also be created, printed and saved on a time-controlled basis, without any need for user access. The Excel Report fully supports compression structures (AC - archive compression) of WinCC OA.

Add-ons	Task
<b>Communication Center</b>	Stands for modern alarm management/remote alerting and communication using the latest standards and various media. The Communication Center creates synergies by using the various interfaces for remote alerting via the control system. Text message and email media are covered with the Communication Center.
<b>VIDEO (see figure below)</b>	Enables the integration of a video management system in WinCC OA. Through the combination of SCADA and video monitoring in one system, the costs for separate video interfaces and the additional expense of maintenance and operation can be saved, and the period of training for operating personnel can also be reduced.
<b>HTTP server</b>	For displaying WinCC OA data via Intranet and Web.
<b>Authentication via Kerberos</b>	A WinCC OA system can be exposed to a variety of attacks. An unauthorized WinCC OA system could set up a connection to the distribution manager or hackers could try to manipulate WinCC OA messages. Secure authentication has been developed to prevent such attacks. The authentication based on Kerberos enables each WinCC OA component to verify the identity of another component. WinCC OA servers can verify the identity of the clients and clients can verify the identity of the servers. In addition, Kerberos ensures that messages are not modified during their transmission (capture-replay attacks are prevented). Furthermore, it is also possible to send messages in encrypted form.
<b>WinCC OA Mobile UI</b>	The mobile UI is a native UI for Android and iOS. The app can be downloaded from the appropriate app store. Use requires configuration of a web server. Only the number of simultaneously active mobile UIs is counted. Supported Android and iOS devices are listed in the online help.
<b>WinCC-OA Desktop UI</b>	An additional operator station license with all server operator station functionalities. Only the number of simultaneously active Desktop UIs is counted. Use requires installation on the server and configuration of a web server. Engineering in the Desktop UI is not possible.
<b>Ultralight UX Client</b>	A "thin client" that is suitable for plant access via a PC workstation and a browser. Access is possible via a standard Web browser without the need for any additional installations. Only the number of simultaneously active Ultralight UXs is counted. Supports a subset of the standard client functionality. Please note the Ultralight UX Client restrictions in the online help.
<b>WinCC OA OPERATOR</b>	Permits operation and visualization of a WinCC OA installation via iPhone and iPad. Process data, plant availability, and plant status can all be displayed. Location filtering provides a rapid overview of all spatially distributed systems including summation alarms.
<b>Disaster Recovery System</b>	This system expands the simple redundancy to include a second redundant system, to which the system can switch over in the event of a fault (e.g. fire or explosion in the building of the primary system). By means of this additional local redundancy, the highest level of system stability is obtained.

Function (continued)

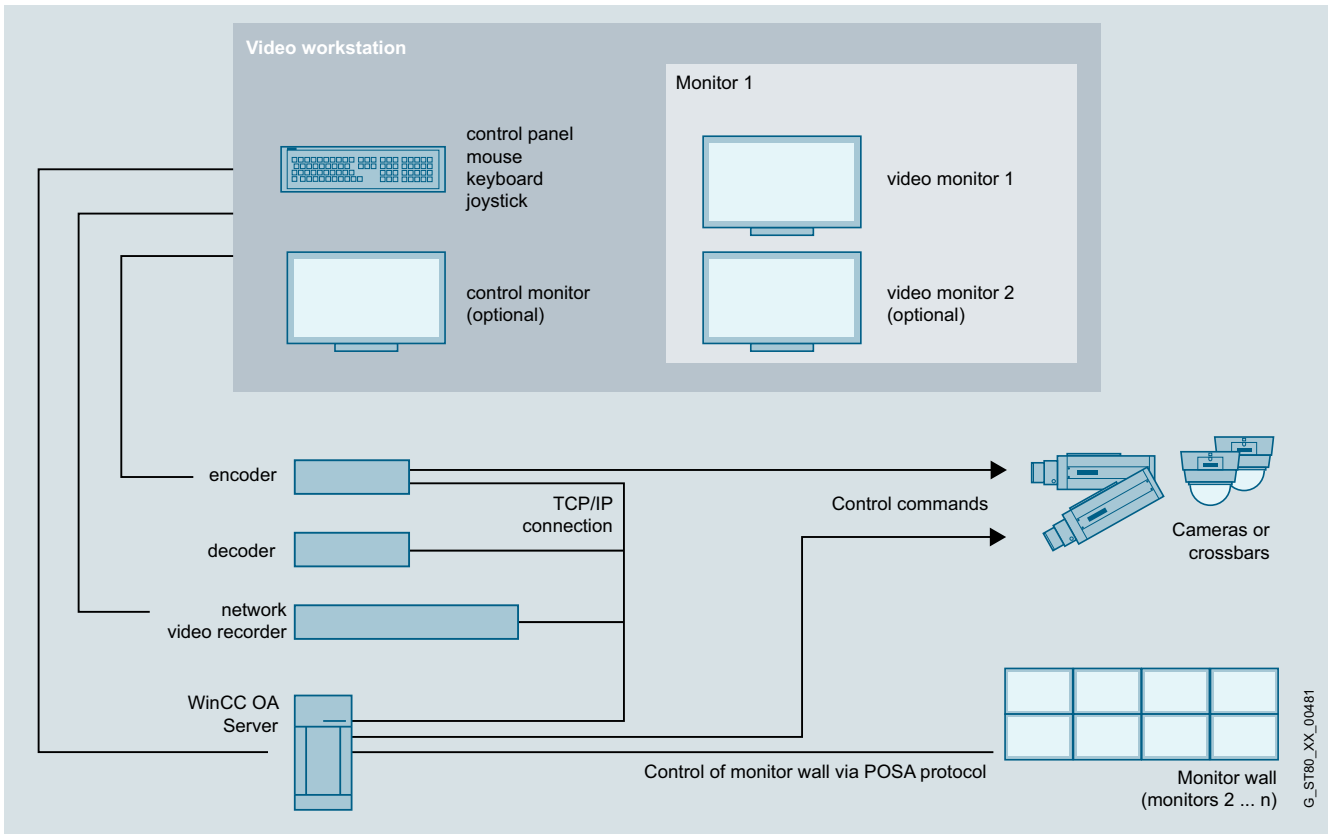

Network topology Video

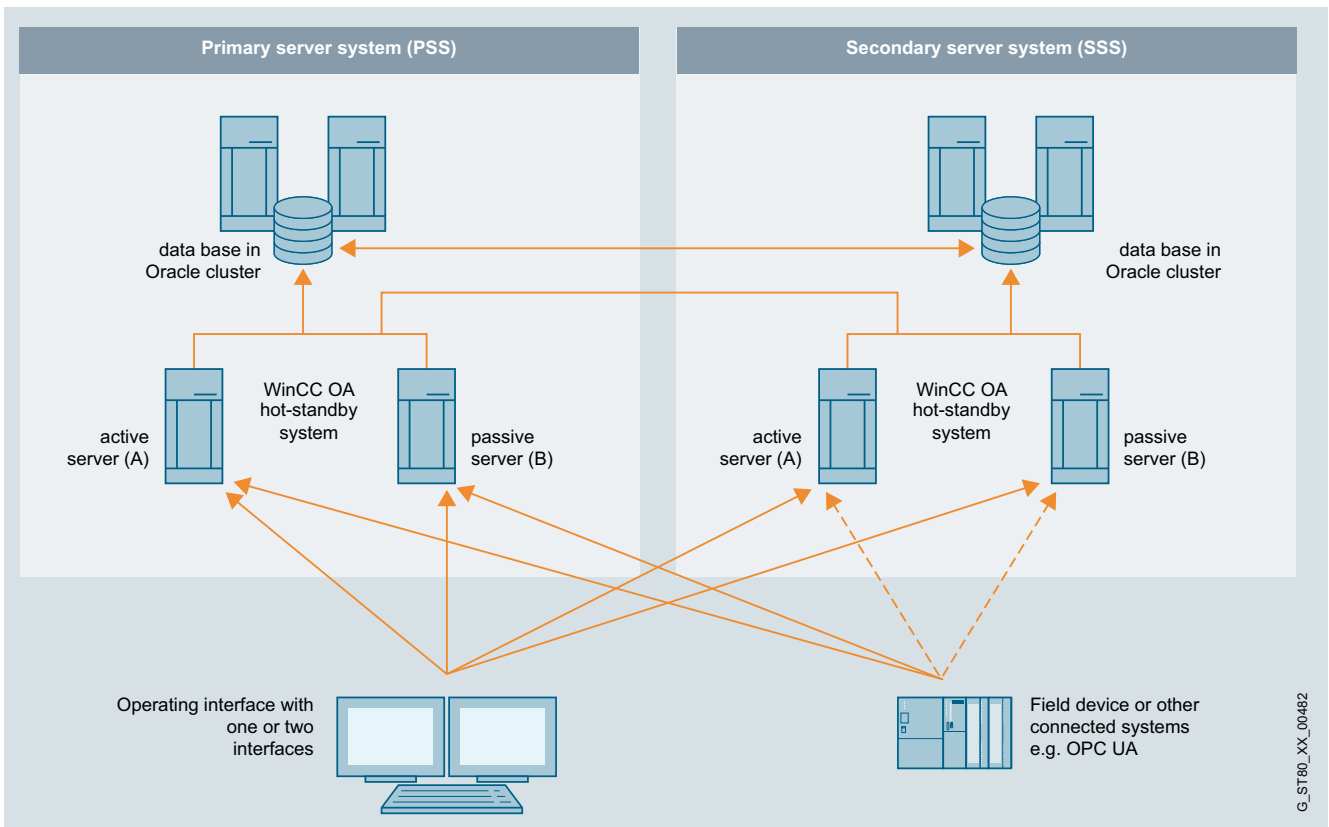

Disaster Recovery System architecture with WinCC OA

## HMI Software

### SCADA System SIMATIC WinCC Open Architecture

#### SIMATIC WinCC Open Architecture add-ons

Ordering data	Article No.	Article No.	
<p><b>SIMATIC WinCC Open Architecture add-ons</b></p> <p><b>WinCC OA SmartSCADA 3.16 KPI Toolbox</b></p> <p>Allows performance indicator definitions and performance indicator instances to be created either in the user-friendly formula editor or freely in the CONTROL. The devices are connected by means of a context-based search in the system model or in data points. The performance indicators can be calculated manually, event-driven or cyclically. Online engineering takes place in its own Wizard (no para license included). It includes 20 KPI instances.</p>	6AV6352-1PA31-6AA0	<p><b>WinCC OA S7 AdvancedLib</b></p> <p>Runtime license for using the object library WinCC OA S7 AdvancedLib, coordinated with the SIMATIC object library also supplied, which is free of charge until revoked. License required for each server. The PLC section of this library is the intellectual property of Siemens AG - a software sublicense contract to this effect must be signed and returned before the SIMATIC Object Library can be obtained.</p>	6AV6352-1DD31-6AA0
<p><b>WinCC OA SmartSCADA 3.16 KPI Expansion 100</b></p> <p>Performance indicator toolbox expanded to include another 100 KPI instances.</p>	6AV6352-1PB31-6AA0	<p><b>WinCC OA Maintenance</b></p> <p>Maintenance management for recording operating hours, switching cycles, alarm handling and notepad function. License required for each server.</p>	6AV6352-1DE31-6AA0
<p><b>WinCC OA SmartSCADA 3.16 Analysis Toolbox, 1 year subscription</b></p> <p>Wizards enable the data analysis of historical data and the learning of a statistical mode for system classification. The integration of the "R" CONTROL statistics toolbox makes a large variety of statistical evaluations available. Online engineering takes place in its own Wizard (no para license included). The license can only be issued for a limited period (subscription model). The time limitation applies to this feature only, and not to the complete WinCC OA license.</p>	6AV6352-1PC31-6AA0	<p><b>WinCC OA Scheduler</b></p> <p>Daily, weekly and monthly program, as well as individual non-periodic events with consideration of public holidays, assignment of priority and override function. License required for each server.</p>	6AV6352-1DF31-6AA0
<p><b>WinCC OA BACnet driver + diagnostics</b></p> <p>Extends a WinCC OA Server to include a license for using the WinCC OA BACnet online engineering environment consisting of WinCC OA BACnet driver, WinCC OA BACnet object library including faceplates, and WinCC OA BACnet browser (max. 5 000 objects per server).</p>	6AV6352-1DA31-6AA0	<p><b>WinCC OA Recipe</b></p> <p>Creation of any recipe types and recipes, acceptance of current process values as recipe, activation/download to data points, import and export (Microsoft Excel). License required for each server.</p>	6AV6352-1DG31-6AA0
<p><b>WinCC OA BACnet Engineering</b></p> <p>Extends a WinCC OA Server to include a license for using the WinCC OA BACnet engineering environment consisting of WinCC OA BACnet browser, WinCC OA EDE-Tool + EDE file interface (requires the WinCC OA engineering license) (max. 5 000 objects per server).</p>	6AV6352-1DB31-6AA0	<p><b>WinCC OA RDB</b></p> <p>RDB Oracle connection for WinCC OA Server. Oracle licenses are not included. License required for each server. (RDB for CentOS and OpenSuse are not supported).</p>	6AV6352-1DH31-6AA0
<p><b>WinCC OA GIS</b></p> <p>GIS viewer for displaying ESRI Shapes Files. A license is required for Pro UI. Can be used in a WinCC OA Desktop UI and WinCC OA Ultralight UX. Maps are not included. Dynamization performed using Ctrl scripting.</p>	6AV6352-1DC31-6AA0	<p><b>WinCC OA DB Logger</b></p> <p>The WinCC OA DB Logger permits the export of freely selectable data from WinCC OA to an external database. See the online help for further information.</p> <p><b>Solution Frameworks</b></p> <p>The Solution Frameworks are only available in combination with consulting and additional testing overhead, and not as standard products.</p>	6AV6352-1DJ31-6AA0
		<p><b>WinCC OA PMS</b></p> <p>Application framework for the implementation of production management systems. The framework offers functions for recording and evaluating production and batch-related quality data. The framework also offers functions for fine production planning and machine assignment. A system administration according to ANSI S95 can be implemented at little cost. This item is not available as a sole product, only in combination with consulting and additional testing overhead.</p>	6AV6352-1EA31-6AA0

Ordering data	Article No.	Article No.
<b>WinCC OA topology package</b> The topology package is an application framework enabling the topological coloring of network views. A qualitative statement is made regarding which parts (nodes, line section, etc.) of a network are directly connected to which in-feed units in a connection established by switching elements. This item is not available as a sole product, only in combination with consulting and additional testing overhead.	<b>6AV6352-1EB31-6AA0</b>	<b>Communication Center</b> Remote alarm messaging via text message and email. Basic package for alarms. Output as text message or e-mail is possible. Price per WinCC OA Server.
<b>WinCC OA ACAS</b> WinCC OA Advanced Command Authority Suite framework for managing and visualizing authority settings. The license includes the management panel and panel expansions for alarm, horn and acknowledgement functions. This item is not available as a sole product, only in combination with consulting and additional testing overhead.	<b>6AV6352-1EC31-6AA0</b>	<b>WinCC OA CommCenter 1</b> Basic package for 25 alarms.
<b>WinCC OA APM</b> The WinCC OA Framework APM – Advanced Playback Manager – allows you to play back the system status of the real-time system in a test/simulation system. The APM offers the following functions: Snapshot (moment in time), playback (time range), training sequence. Please note that the APM Package does not include any simulation of the process or of the associated open loop control. Since APM is a framework, we urgently recommend that you use our Consulting Service for project-specific integration.	<b>6AV6352-1ED31-6AA0</b>	<b>WinCC OA CommCenter 2</b> Basic package for 250 alarms.
<b>Reporting</b> Expands a WinCC OA Server to include a reporting interface for active connections (clients) for the evaluation of WinCC OA data by means of a third-party tool such as BIRT, Crystal Reports or MS Excel. (In WinCC OA Version 3.16, the existing Excel Report is still supported and is automatically supplied along with the WinCC OA Reporting option.) Licenses for third-party tools are not supplied. <ul style="list-style-type: none"> <li>• 1 client</li> <li>• 2 clients</li> <li>• 5 clients</li> <li>• 10 clients</li> </ul>	<b>6AV6352-1FE31-6AA0</b> <b>6AV6352-1FF31-6AA0</b> <b>6AV6352-1FG31-6AA0</b> <b>6AV6352-1FH31-6AA0</b>	<b>WinCC OA CommCenter 3</b> Basic package for 2 500 alarms.
		<b>WinCC OA CommCenter 4</b> Basic package for unlimited alarms.
		<b>Video management</b> Permits the display of video streams in the client UI, as well as the control of video equipment (swivel cameras, recorders, ...). More detailed information and details of supported hardware can be obtained from the online help. Streams are parallel, actively displayed external or displayed recorded video signals. Necessary WinCC OA Server licenses do not require additional I/Os. Two licenses are required for one redundant WinCC OA server pair.
		<b>WinCC OA Video Light</b> Permits connection of 16 video inputs (cameras) and simultaneous display of 4 video outputs (streams). This package cannot be expanded.
		<b>WinCC OA Video Basic</b> The Video Basic package facilitates operation of the WinCC OA Video add-on. It includes numerous features required for video functions. Does not contain any cameras; these must be purchased separately.
		<b>WinCC OA Video - Video sources</b> With this expansion license, additional cameras are integrated into the system in addition to the basic package. <ul style="list-style-type: none"> <li>• WinCC OA Video – 1 video source</li> <li>• WinCC OA Video – 25 video sources</li> <li>• WinCC OA Video – 50 video sources</li> <li>• WinCC OA Video – 100 video sources</li> <li>• WinCC OA Video – 250 video sources</li> <li>• WinCC OA Video – 500 video sources</li> </ul>

## HMI Software

### SCADA System SIMATIC WinCC Open Architecture

#### SIMATIC WinCC Open Architecture add-ons

Ordering data	Article No.	Article No.	
<b>WinCC OA Video Display</b> Expands the video basic system with a second external display (one is already included in the basic package).	6AV6352-1JQ31-6AA0	<b>AMS Medium 1 000 A/E</b> The license includes the AMS application as well as up to 1 000 A/E = 1 000 checklists assigned to alarm/event DP. <sup>1)2)3)</sup>	6AV6352-1MD31-6AA0
<b>WinCC OA Web Server</b> Allows the management of different connections and resources between the WinCC OA Server and the WinCC OA UIs as well as Ultra-light UX Clients. The Load Balancing feature can be activated with a number greater than 1. This feature distributes the load of multiple clients evenly across the different Web servers, thus allowing it to be scaled. With remote Web servers, multilevel architectures such as access to DMZs (demilitarized zones) can be implemented. (1 Web server is already included in the WinCC OA Server)	6AV6351-1JV31-6AA0	<b>AMS Large 5 000 A/E</b> The license includes the AMS application as well as up to 5 000 A/E = 5 000 checklists assigned to alarm/event DP. <sup>1)2)3)</sup>	6AV6352-1ME31-6AA0
<b>Kerberos</b> <b>WinCC OA Secure</b> Extends a WinCC OA Server to include protection by Kerberos. Each WinCC OA Server requires a separate WinCC OA Secure license.	6AV6352-1LA31-6AA0	<b>AMS Upgrade Large</b> The license contains an upgrade of the AMS Large 5 000 A/E license with 1 000 A/E = 1 000 checklists assigned to alarm/event DP.	6AV6352-1MF31-6AA0
<b>AMS (Advanced Maintenance Suite)</b> For the effective planning, administration, implementation and monitoring of maintenance work and faults. The processes are evaluated by means of statistics and reports are communicated. AMS is always only available in combination with consulting and additional testing overhead.		<b>AMS UL A/E</b> The license includes the AMS application as well as an unlimited number of alarm/event DP checklist assignments. <sup>1)2)3)</sup>	6AV6352-1MG31-6AA0
<b>AMS Starter Package 20A/E</b> This fully functional trial license valid for 90 days includes the AMS application as well as up to 20 A/E = 20 checklists assigned to alarm/event DP. <sup>1)2)3)</sup>	6AV6352-1MA31-6AA0	<b>AMS Client 2 UI</b> Operating station license for simultaneous use of no more than 2 parallel client sessions. The client license can be installed on more than one PC – only the number of simultaneously active clients is counted.	6AV6352-1MH31-6AA0
<b>AMS Entry 20 A/E</b> The license includes the AMS application as well as up to 20 A/E = 20 checklists assigned to alarm/event DP. <sup>1)2)3)</sup>	6AV6352-1MB31-6AA0	<b>AMS Client 5 UI</b> Operating station license for simultaneous use of no more than 5 parallel client sessions. The client license can be installed on more than one PC – only the number of simultaneously active clients is counted.	6AV6352-1MJ31-6AA0
<b>AMS Small 100 A/E</b> The license includes the AMS application as well as up to 100 A/E = 100 checklists assigned to alarm/event DP. <sup>1)2)3)</sup>	6AV6352-1MC31-6AA0	<b>AMS Client 10 UI</b> Operating station license for simultaneous use of no more than 10 parallel client sessions. The client license can be installed on more than one PC – only the number of simultaneously active clients is counted.	6AV6352-1MK31-6AA0

- 1) The basic price also includes the AMS Reports packages.
- 2) AMS importer as well as 1 day of consulting for initial conceptualization by ETM Consultants (excluding travel expenses) and 5 hours of telephone support within 3 months after delivery.
- 3) AMS Reports and AMS Importer, and 1 day of consulting for initial conceptualization by ETM consultants (excluding travel expenses). This license does not include any support and cannot be expanded or extended.

More information is available on the Internet at:

<http://www.siemens.com/wincc-open-architecture>

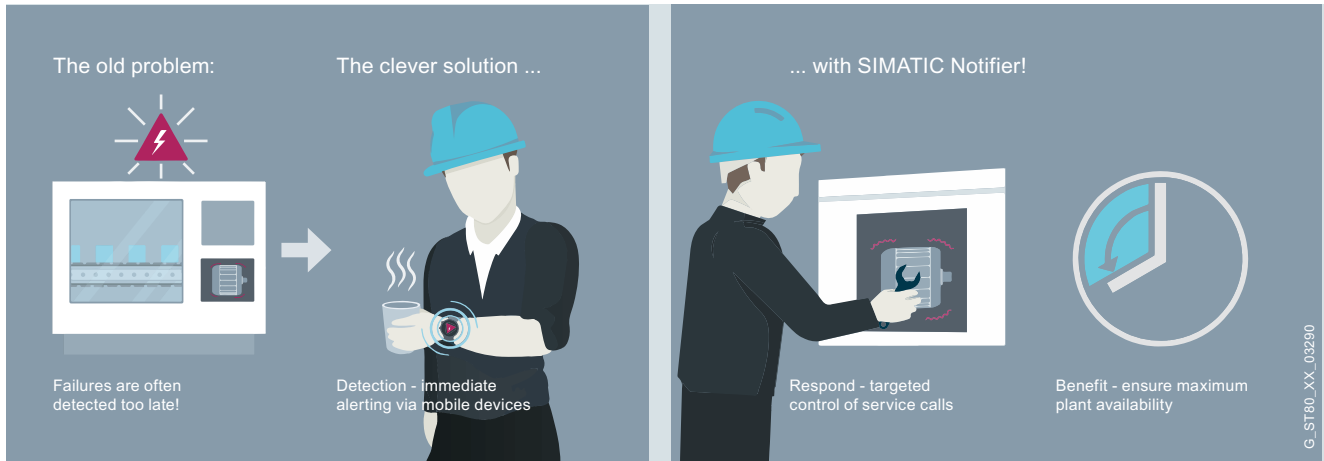
**Overview**

SIMATIC Notifier

**SIMATIC Notifier: Detect. React. Benefit.**

SIMATIC Notifier is used to provide targeted notifications to employees on their smart devices. The web-based configuration is performed on the Notifier Server in advance for groups or each individual device.

The SIMATIC Notifier Client app receives the notifications. S7, S7 Classic or OPC UA communication is required for integration into a system/machine.

Licenses:

- SIMATIC Notifier Server
- SIMATIC Notifier Client License (unlimited expansion options, depending on the number of linked smart devices)

**Benefits**

- Detection and localization of plant or machine faults
- Direct notification on smartwatches, smartphones and tablets
- Increased productivity by avoiding downtimes
- Increased freedom of movement and ability to reach employees via wireless LAN communication

**Application**

- Plants and machines with operator intervention
- Long production lines, individual machines or total systems
- Simple retrofit/integration
- Fast and user-friendly configuration
- Licensing based on number of connected smart devices (smartwatch, smartphone or tablet)

## HMI Software

Notification software for mobile devices

### SIMATIC Notifier

#### Function

- Notifications on smart devices
- User and role management
- Different notification categories: Alert, warning and information
- Customizable notification texts and triggering conditions
- "Take over" feature for team applications

#### Technical specifications

	SIMATIC Notifier
<b>Machine integration</b>	S7 Classic, S7+, OPC UA
<b>Max. number of controllers/machines</b>	30x S7 or 30x OPC UA or 30x mixed configurations <sup>1)</sup>
<b>Max. number of variables per second per machine</b>	50 <sup>1)</sup>
<b>Max. number of variables per second per Notifier Server</b>	1500 <sup>1)</sup>
<b>Max. number of connected smart devices per Notifier Server</b>	50 <sup>1)</sup>
<b>Minimum requirements for smart-watch OS</b>	Android Wear 2
<b>Minimum requirements for a Windows PC</b>	Windows 7 or 10 (64-bit), 4 GB RAM; Internet Explorer or Google Chrome
<b>Availability</b>	In countries as per OSD country list (Online Software Delivery)

<sup>1)</sup> Depending on the performance of the Windows PC used

#### Ordering data

#### Article No.

##### SIMATIC Notifier Server 1.0 for Win7 or Win10 (64-bit)

SIMATIC Notifier Server license key, download + SIMATIC Notifier Server software, download. Including a SIMATIC Notifier Client license. Email address required for delivery.

6AV2170-0AA10-0AA0

##### SIMATIC Notifier Client license

Freely expandable Client license, download. Email address required for delivery.

6AV2170-0AA20-0AA0

#### More information

More information is available at:

<http://www.siemens.com/simatic-notifier>



## Overview

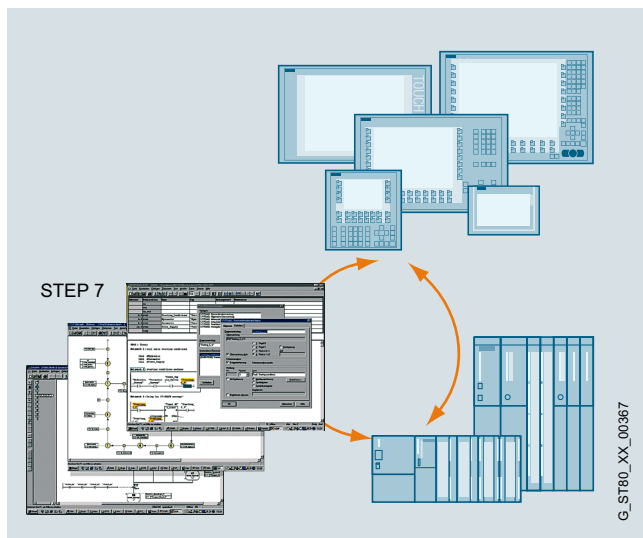

Process fault diagnostics with ProAgent for WinCC flexible/ProAgent and with the STEP 7 engineering tools

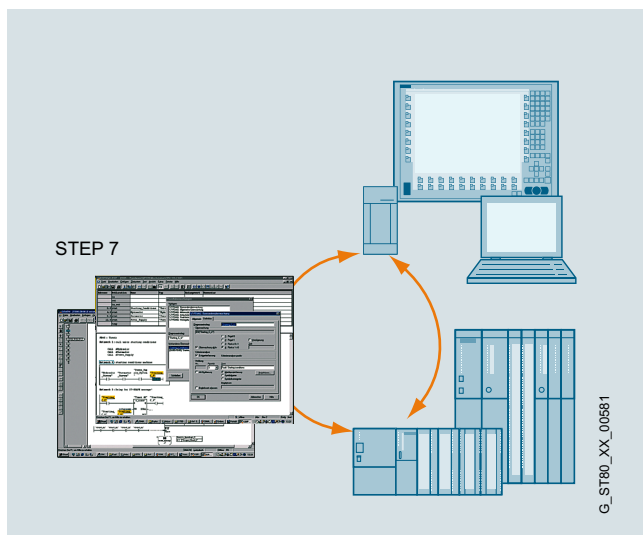

- Process error diagnosis software for quick and precise diagnosis of faults/errors in plants and machines for SIMATIC S7 and SIMATIC HMI
- Standardized diagnostics concept for various SIMATIC components: optimum interaction of STEP 7 engineering tools and SIMATIC HMI
- Standardized user interface

### Licensing:

Runtime software, one license is required for each piece of target hardware.

You can find more information on the Software Update Service, license types, online software delivery and handling your SW licenses with the Automation License Manager here:

<http://www.siemens.com/simatic-licenses>

## Benefits

- Integral component of Totally Integrated Automation (TIA): increases productivity, minimizes the engineering outlay, reduces the lifecycle costs
- ProAgent:
  - Provides optimum support for plant and machine personnel in respect of troubleshooting and fault rectification
  - Increases plant availability
  - Reduces downtimes
- No further configuration overhead for diagnostics functionality
- Frees up PLC capacity with regard to memory and program execution time
- No special operator know-how is required thanks to clearly comprehensible indication of the cause of error

## Application

Increased productivity is being achieved more and more by cutting costs. In this context, the focus is increasingly on maintenance. The emphasis here is on rectifying faults as quickly and efficiently as possible. Ideally, the operating personnel should also perform part of the maintenance tasks. The operating personnel are on-site, they are familiar with the procedures and can intervene quickly. This saves time and reduces costs. It is precisely here that ProAgent can assist operating personnel in identifying faults quickly, in particular in the automotive and machine tool industries.

In the event of a process fault, process fault diagnosis with SIMATIC ProAgent will provide information about the location and cause of that fault and support personnel with troubleshooting.

The ProAgent solution has been optimized specifically for use with SIMATIC S7-300/S7-400 and SIMATIC WinAC. It can be used in combination with the S7-PDIAG, S7-GRAPH and S7-HiGraph<sup>1)</sup> STEP 7 engineering tools. The ProAgent option package features standard displays that are updated with process-specific data during runtime.

<sup>1)</sup> Process diagnostics with S7-HiGraph in combination with TP/OP/MP 270/277, MP 370/377, and C7636 and PC RT systems.

## HMI Software

### SIMATIC ProAgent process diagnostics software

#### SIMATIC ProAgent

##### Function

- Context-sensitive diagnostics initiation due to process error message
- Output of operands with symbols and comment
- Switching is possible between LAD, STL and signal list
- Supporting fault rectification with direct process access when using the motion display
- Output of the faulty operands directly in the message including address, symbol and comment<sup>1)</sup>
- Consistency test in RT:  
Inconsistent diagnostic units are marked with icons. This permits quick locating of faults regarding configured data in the commissioning phase.
- Direct, unit-related entry point in the diagnostic display from user displays by using ProAgent functions
- Unit or message-related entry to STEP 7 (LAD/STL/FBD editor, S7-GGRAPH, HW CONFIG (upon system error messages)), supported fully automatically<sup>2)</sup>
- Unit or message-related entry to STEP 7, supported fully automatically<sup>3)</sup>
- Graphic display of step sequences (overview display)<sup>4)</sup>

<sup>1)</sup> In combination with TP/OP/MP 270/277, MP 370/377, C7 636, WinCC/ProAgent as of V6.0, and WinCC flexible/ProAgent

<sup>2)</sup> WinCC/ProAgent as of V5.5 and as of WinCC flexible 2007/ProAgent on PC RT

<sup>3)</sup> Only WinCC/ProAgent as of V5.5

<sup>4)</sup> As of WinCC flexible 2007/ProAgent, WinCC/ProAgent as of V5.6 in combination with S7-GGRAPH as of V5.1 (OCX is delivered as of S7-GGRAPH 5.1)

##### Standardized user interface with standard displays

- Message display
- Unit overview
- Diagnostics detail display
- Motion display
- Sequencer operating display

The displayed image contents are related to the previously selected units or messages. This means that the proper context-sensitive diagnostics display can be called up based on a message or a selected technological unit.

##### Message display

All of the existing process messages are shown in the message display. Context-sensitive branching to other diagnostic displays is also possible with a selected message. The operating personnel can also take the message directly from the erroneous operands and react immediately without having to perform any other operations on the HMI device. WinCC flexible permits this function on the Windows CE-based devices TP/OP/MP 270/277, MP 370/377, and on PC Runtime systems. The function is available as of version 6.0 for WinCC/ProAgent.

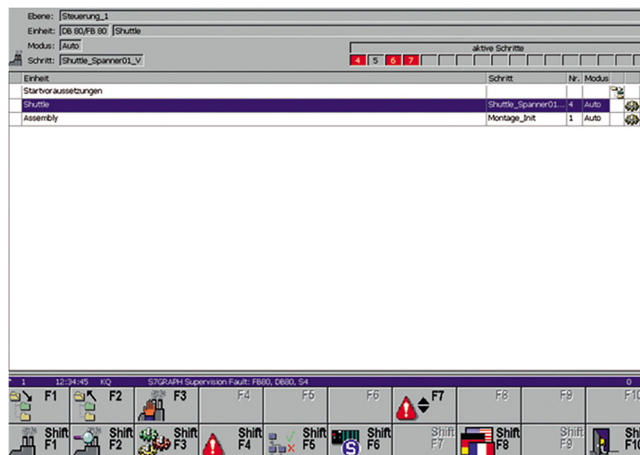

##### Unit overview

The unit overview displays all technological units and the respective sub-units (system/machine components) in table form. In this display, the user is able to recognize, for example, which operating mode or which status the respective unit is in. The operating mode can be changed by the user if required.

Faulty units are marked with attributes.

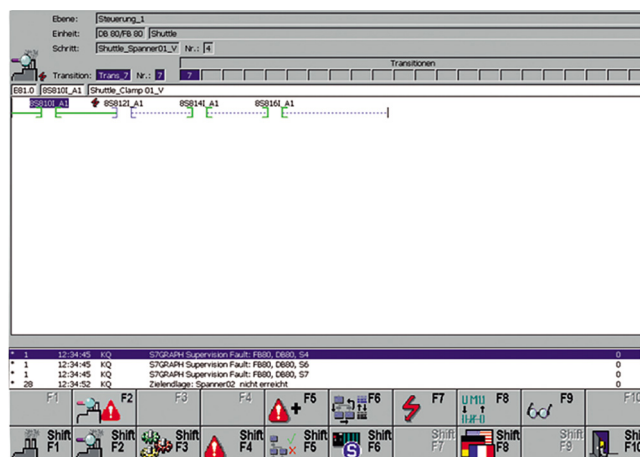

**Function** (continued)**Diagnostics detail display**

The diagnostics detail display shows the faulty operands at the time of origination of a process error. As an option, current status information can also be displayed. The diagnostics results are either displayed in a ladder diagram (LAD), statement list (STL), or in a clearly arranged signal list overview. The output of the operands depends on the display format with symbols and comments from the S7 symbol table. Only the operands that cause the fault are displayed and marked with a highlighted attribute. Switching to a display that calls up the current status of all operands in the controller is also possible.

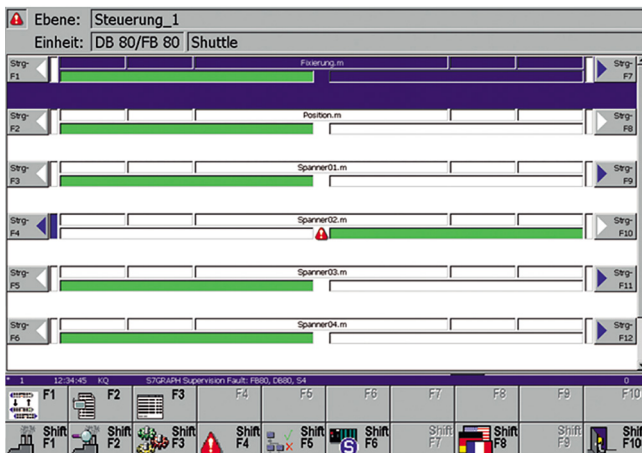
**Motion display**

The motion display is used for supported fault rectification. Every motion line contains a comment line that describes the motion (e.g. x-axis), two actions for implementing the motion, response concerning the actuation of a motion and information on the respectively achieved end positions (max. 16).

The motion itself is controlled with softkeys on the side of SIMATIC Panels and Multi Panels. For time-critical motions, the actuation can be done directly through inputs of the controller (depending on the capabilities of the target hardware: 24 V direct keys, DP direct keys via PROFIBUS).

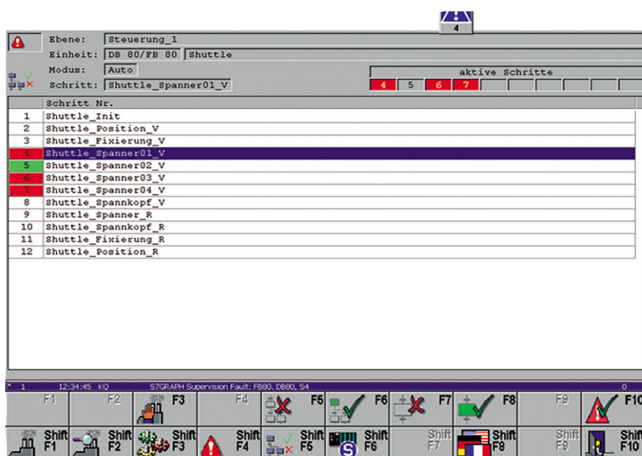
**Sequencer operating display**

The sequencer operating display supports sequencer control. This makes functions such as initializing and acknowledging sequencers, activating/deactivating individual steps and operating mode settings possible analog to the status/control in S7-GRAPH.

The steps are output to a list with step number/name. Attributes for identifying an active/faulty step give the operating personnel an overview of the current status of the step sequence.

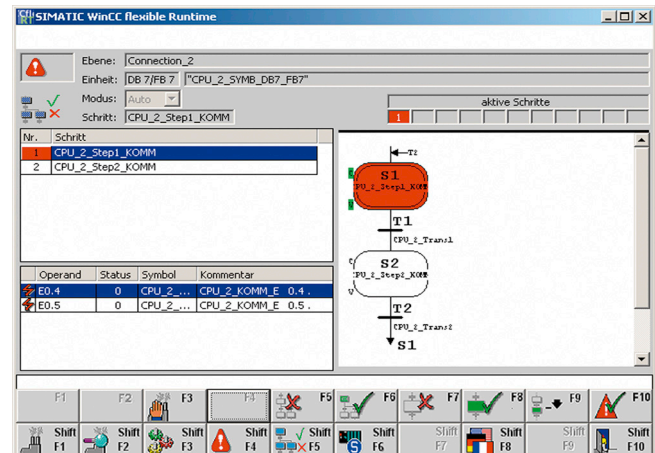
**Sequencer diagnostic display**

WinCC flexible/ProAgent and WinCC/ProAgent<sup>1)</sup> also offer capabilities for graphic monitoring and sequencer diagnostics. This gives the user the ability to monitor active/faulty steps as well as the fault cause, e.g. faulty transition conditions, simultaneously on the HMI device.

<sup>1)</sup> WinCC/ProAgent as of V5.6 in combination with S7-GRAPH as of V5.1 (OCX is delivered as of S7-GRAPH 5.1)

**HMI Software**

## SIMATIC ProAgent process diagnostics software

**SIMATIC ProAgent****Ordering data****Article No.****SIMATIC WinCC/ProAgent**

Software option package for process diagnosis based on S7 GRAPH V5 and higher and S7 PDIAG V5 and higher; functional enhancement for SIMATIC WinCC; electronic documentation in English, French and German; functions and standard screens for use on a PC (resolution 1024 x 768 pixels) and Panel PC 577/677/877 15" (resolution 1024 x 768 pixels) in English, French and German, runtime license (single license)

WinCC version:

- V7.5<sup>1)</sup>
- V7.4<sup>1)</sup>

**6AV6371-1DG07-5AX0****6AV6371-1DG07-4AX0**

As download

- V7.5<sup>1)</sup>
- V7.4<sup>1)</sup>

**6AV6371-1HG07-5AX0****6AV6371-1HG07-4AX0****Upgrade**

- V7.4 to V7.5<sup>1)</sup>
- V7.2/3 to V7.5<sup>1)</sup>
- V7.x to V7.4<sup>1)</sup>

**6AV6371-1DG07-5AX4****6AV6371-1DG07-5AX3****6AV6371-1DG07-4AX3**

As download

- V7.4 to V7.5<sup>1)</sup>
- V7.2/3 to V7.5<sup>1)</sup>
- V7.x to V7.4<sup>1)</sup>

**6AV6371-1KG07-5AX4****6AV6371-1KG07-5AX3****6AV6371-1KG07-4AX3****SIMATIC WinCC flexible/ProAgent**

Software option package for process diagnostics based on S7 PDIAG V5.1 and higher, S7 GRAPH V5.2 + SP3 and higher; S7 HiGRAPH V5.3 and higher. Functional enhancement for SIMATIC WinCC flexible; electronic documentation in English, French, German, Italian, and Spanish

- **WinCC flexible/ProAgent for SIMATIC Panels**  
Runtime license (single license) executable on TP/OP/MP 270/277, Mobile Panel 277, and MP 370/377
- **WinCC flexible /ProAgent for WinCC flexible Runtime**  
Runtime license (single license)

**6AV6618-7DB01-3AB0****6AV6618-7DD01-3AB0**

<sup>1)</sup> Not multi-station-capable